

Preface

Thanks for choosing V350 series low-power closed-loop vector inverter produced by Shenzhen Sunfar Electric Technologies Co., Ltd.

This Manual is the operating manual for V350 series closed-loop vector frequency inverter. It provides all relevant instructions and precautions for installation, wiring, functional parameters, daily care and maintenance, fault diagnosis and troubleshooting of V350 series inverters.

In order to use this series of inverters correctly, guarantee product's best performance and ensure safety of users and equipment, be sure to read this manual carefully before using V350 series inverters. Improper use may cause abnormality and malfunction of the inverter, reduce its service life and even damage equipments and lead to personal injury and death, etc.

This user manual is delivered with the device. Please keep it properly for future overhaul and maintenance.

Owing to constant improvement of products, all data may be changed without further notice.



SHENZHEN SUNFAR ELECTRIC TECHNOLOGIES CO., Ltd.

V350 series low-power closed-loop vector inverter User Manual

Version: V1.3

Revision Date: April 2017

Contents

1	Product Confirmation And Operation Precautions	1
1.1	Product confirmation	1
1.1.1	Precautions of unpacking inspection	1
1.2	Safety precautions	2
1.2.1	Installation precautions	2
1.2.2	Safety precautions for wiring	2
1.2.3	Safety precautions for running operation	3
1.2.4	Safety caution for maintenance check	3
1.3	Knowledge on operation	4
1.3.1	Application knowledge of driving general motor	4
1.3.2	Application knowledge of driving special motor	4
1.3.3	Ambient environment	4
1.3.4	Connection knowledge of peripheral equipment	4
1.3.5	Transportation and storage	5
1.4	Abandon caution	5
1.5	Other cautions	5
2	Product Introduction	6
2.1	Model description	6
2.2	Product appearance	6
2.3	Model table	7
2.4	Product technical index and specifications	7
3	Installation Of Frequency Inverter	11
3.1	Installation of frequency inverter	11
3.2	Size and assembly of operation panel	13
3.3	Installation size of the panel	14
3.4	Removal of terminal cover	15
3.5	Installation size of inverters	16
4	Wiring Of Frequency Inverter	17
4.1	Wiring precautions	17
4.2	Connection of optional fittings and frequency inverter	18

4.3	Wiring of control terminals	21
4.3.1	Wiring of standard terminals of control panel	21
4.3.2	Function description of control terminal	21
4.3.3	Description of dial switch on the control panel	22
4.4	Wiring Of Major Loop Terminal.....	23
4.4.1	Terminal Functions.....	23
4.4.2	Main loop terminal diagram.....	24
4.5	Wiring for basic operation of inverters.....	26
5	Operation And Simple Running Of Frequency Inverter.....	27
5.1	Basic function of the panel.....	27
5.1.1	Panel description	27
5.2	Basic functions and operating methods of panel	30
5.2.1	Basic functions of panel	30
5.2.2	Operating methods of panel.....	32
5.3	Simple running of frequency inverter	34
5.3.1	Initial settings	34
5.3.2	Simple operation	35
6	Functional Parameter Table	37
6.1	System management parameter.....	38
6.2	Running command selection.....	42
6.3	Frequency setting	43
6.4	Control command source.....	44
6.5	Start and stop.....	44
6.6	Acceleration and deceleration characteristics parameters.....	46
6.7	Carrier frequency	47
6.8	V/F parameters and overload protection.....	47
6.9	Steady running.....	48
6.10	Motor parameters.....	50
6.11	Parameter measurement and pre-excitation	50
6.12	Multifunctional input terminal	51
6.13	Multifunctional output terminal multifunctional output terminal.....	52
6.14	Pulse input	53

6.15	Pulse output.....	53
6.16	Analog input.....	54
6.17	Analog input curve correction	54
6.18	Analog output.....	55
6.19	Analog input wire breakage detection	56
6.20	Virtual analog input	57
6.21	Hopping frequency.....	58
6.22	Built-in auxiliary timer.....	58
6.23	Built-in auxiliary counter.....	60
6.24	Auxiliary functions.....	61
6.25	Multi-stage frequency setting.....	63
6.26	Simple programmable multi-stage operation	64
6.27	Swing frequency operation	66
6.28	Process PID (4ms control cycle).....	67
6.29	Process PID multi-stage setting.....	70
6.30	Process PID sleep function.....	70
6.31	Revolution setting and feedback.....	71
6.32	Revolution closed-loop parameters.....	73
6.33	Protection parameter	74
6.34	Torque control.....	74
6.35	MODBUS fieldbus.....	76
6.36	Mapping access parameter.....	76
6.37	Communication linkage synchronous control.....	77
6.38	Expansion multifunctional input terminal.....	78
6.39	Expansion multifunctional output terminal.....	78
6.40	Zero-speed torque and position control	78
6.41	Virtual input and output.....	79
6.42	Protection function configuration parameters.....	80
6.43	Correction parameter	82
6.44	Special functional parameters.....	82
6.45	Other configuration parameters	83
6.46	Historical fault recording	84

6.47	Operation status at the last fault	84
6.48	Basic status parameter	85
6.49	Auxiliary status parameter	87
6.50	MODBUS fieldbus status parameter	88
6.51	Terminal status and variable	88
6.52	Counter timer value.....	89
6.53	Positioning status parameter.....	89
6.54	Equipment information.....	89
	Exhibit 1 Comparison table of multifunctional terminal (DI/EDI/SDI) functions	91
	Exhibit 2 Comparison table of multifunctional output terminal (DO/EDO/SDO).....	93
	Exhibit 3 Monitor variable comparison table	94
7	Function Details	96
7.1	System management (Group F0.0).....	96
7.2	Running command selection (Group F0.1)	105
7.3	Frequency setup (Group F0.2).....	107
7.4	Control command source (Group F0.3)	110
7.5	Start and stop (Group F0.4)	112
7.6	Acceleration and deceleration characteristics (Group F1.0)	118
7.7	Carrier frequency (Group F1.1).....	120
7.8	V/F parameters and overload protection (Group F1.2)	121
7.9	Steady running (Group F1.4)	123
7.10	Motor parameters (Group F2.0)	126
7.11	Parameter measurement and pre-excitation (Group F2.2).....	127
7.12	Multifunctional input terminal (Group F3.0)	128
7.13	Multifunctional output terminal (Group F3.1).....	137
7.14	Pulse input (Group F3.2).....	140
7.15	Pulse output (Group F3.3)	141
7.16	Analog input (Group F4.0)	142
7.17	Analog input curve correction (Group F4.1)	143
7.18	Analog output (Group F4.2)	144
7.19	Analog input wire-break detection (Group F4.3)	145
7.20	Hopping frequency (Group F5.0)	146
7.21	Built-in auxiliary timer (Group F5.1)	147

7.22	Built-in auxiliary counter (Group F5.2)	149
7.23	Auxiliary functions (Group F5.3)	150
7.24	Multi-stage frequency setting (Group F6.0).....	154
7.25	Simple programmable multi-stage operation (Group F6.1)	155
7.26	Swing frequency operation (Group F6.2).....	159
7.27	Process PID (4ms control cycle) (Group F7.0)	162
7.28	Process PID multi-stage setting (Group F7.1)	166
7.29	Process PID sleeping function (Group F7.2).....	166
7.30	Revolution setting and feedback (Group F8.0)	167
7.31	Revolution closed-loop parameter (Group F8.1).....	170
7.32	Protective parameters (Group F8.2)	172
7.33	Torque control (Group F8.3).....	173
7.34	MODBUS fieldbus (Group FA.0)	174
7.35	Mapping parameter access (Group FA.1)	174
7.36	Communication linkage synchronous control (Group FA.2).....	176
7.37	Zero-speed torque and position control (Fb.2 group).....	177
7.38	Virtual input and output (group FF.0).....	178
7.39	Protecting function configuration parameters (FF.1 group)	179
7.40	Correction parameters (FF.2 group).....	179
7.41	Special functional parameters (FF.3 Group).....	181
7.42	Other configuration parameters (Group FF.4)	181
8	Warning, Alarm Diagnosis And Countermeasures	183
8.1	Alarm display and troubleshooting.....	183
8.2	Warning display and troubleshooting.....	190
9	Care And Maintenance	194
9.1	Routine care and maintenance	194
9.2	Inspection and displacement of the vulnerable components.....	195
9.2.1	Filter capacitor	195
9.2.2	Cooling fan.....	195
9.3	Storage	196
9.4	Warranty	197

10	Description Of Communication Protocol.....	198
10.1	Protocol overview	198
10.2	Interface and transmission method.....	198
10.3	Data structure	198
10.4	Parameter configuration for frequency inverters.....	199
10.5	Brief introduction of functions.....	199
10.6	Access address summary.....	200
10.7	Detailed modbus address-finding distribution	201
11	EMC.....	207
11.1	CE	207
11.2	Definition	207
11.3	Obey Standard Order	207
11.3.1	Obey EMC Order	207
11.3.2	Obey LVD Order.....	207
11.4	Guidance of EMC External Accessories Installation and Selection.....	208
11.4.1	Notice of EMI Input Filter Installation.....	208
11.4.2	DC Reactor	208
11.4.3	Input Reactor.....	209
11.4.4	AC output reactor	210
11.5	Shielded Cable.....	211
11.6	Cable Wiring Requirements	212
11.7	Leakage current response requirements.....	213
11.8	Common EMC Interference Problem and Solution	214
12	Optional Components	215
12.1	I/O expansion card introduction	216
12.2	PG expansion card introduction.....	220
12.3	Brief introduction to operation panel	221
12.3.1	Outside view of operation panel.....	221
12.3.2	Button function.....	221
12.4	Tension control expansion card	212
12.4.1	Basic product information	212
12.4.2	Product introduction	212

12.4.3	Product function	212
12.4.4	Technical data	212
12.5	Expansion card of all-in-one veneer peeling lathe	223
12.5.1	Basic product information	223
12.5.2	Product introduction	223
12.5.3	Product function	223
12.5.4	Technical data	223
12.6	Guide of brake resistance selection	224
12.6.1	Resistance value selection	224
12.6.2	Power of brake resistance selection	224
12.7	AC/DC reactor	225
12.7.1	DC reactor	225
12.7.2	AC input reactor	226
12.7.3	AC input reactor	227

Chapter 1 Product Confirmation And Operation Precautions

1.1 Product confirmation

Check the outer packing carefully to see if there is any damage after the arrival of the goods; if there is a label on the outer packing, please confirm the model and specification of it to see if they are in accordance with your order. If any damage or discrepancy is found, please contact the supplier promptly for solution.

1.1.1 Precautions of unpacking inspection

Confirm the frequency inverter body and accessories carefully when unpacking, to see if there is any damage during the transit, and if the parts and components are damaged or dropped, and if there is the frequency inverter entity and the following accessories:

- 1) Operation instruction;
- 2) Certification;
- 3) Product list;
- 4) Other ordered accessories.

If there is any omission or damage, please contract the supplier promptly for solution.

- Nameplate of Frequency Inverter

On the frequency inverter, there is a nameplate marked with model, rated parameters, product serial-number and bar code of frequency inverter. The content of nameplate is shown as below:

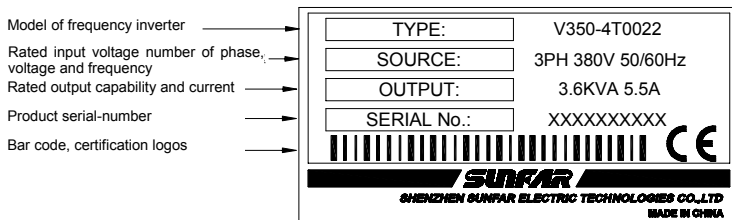

1.2 Safety precautions

Read this instruction carefully prior to installation, wiring, operation and maintenance, to ensure proper operation of this product. "Tip", "Attention", "Danger" and "Warning" in this operation manual are defined as follows:



“Tip” : Tips for some useful information.



“Attention” : Matter requires attention during operation.



“Warning” : Without operation according to the requirements, moderate injuries or minor injuries of personnel and material loss may be caused.



“Danger” : Without operation according to the requirements, serious damage to the equipment or personnel injuries may be caused.

1.2.1 Installation precautions

1. The frequency inverter shall not be installed on combustibles, in case of the risk of fire.
2. The frequency inverter shall not be installed at places with direct sunlight, in case of danger.
3. The frequency inverter of this series shall not be installed in the environment of explosive gases, in case of the danger of explosion.
4. Frequency inverter with damage or lack of components shall not be applied; otherwise it may cause personal injury or fire and other accidents.
5. It is not allowed to dismount or modified the frequency inverter without authorization.
6. No foreign matter is allowed to be dropped into the frequency inverter, in case of breakdown of the frequency inverter.
7. During installation, the frequency inverter shall be installed at the place able to bear its weight; otherwise, it may fall down.

1.2.2 Safety precautions for wiring

1. Please authorize the professional staff to conduct wiring. If the wiring operation is not proper, it may damage to the equipment and the individuals.
2. Please start to wire after the panel digital tube of frequency inverter is out for ten minutes, otherwise, there can be electric shock risk.

3. The grounding terminal of frequency inverter must be reliably grounded; otherwise, there can be electric shock risk.
4. No alternating current power supply is allowed to be connected onto the U, V, W of frequency inverter, otherwise, the frequency inverter can be damaged.
5. Confirm that the input voltage and frequency converter are in consistent with rated voltage value; otherwise, the frequency inverter may be damaged.
6. Confirm that the motor and frequency converter are adaptive with each other, otherwise, the motor can be damaged or frequency converter protection can be caused.
7. Brake resistor can not be connected onto the (+), (-) of DC bus directly; otherwise, there can be fire risk.

1.2.3 Safety precautions for running operation

1. Please do not operate the switch with wet hand; otherwise, there can be electric shock.
2. Please install the front cover prior to plugging in, and shall not demount the cover while power is on, otherwise, here can be electric shock.
3. During the frequency converter is with power on, even the motor is stopped, do not touch the terminals of frequency converter, otherwise, here can be electric shock.
4. If you apply the function of restart, do not approach the load equipment, for it may restart suddenly after alarm removed, otherwise, personal injuries may caused.
5. Please set the system as ensuring personal and property safety even when restarting.
6. Please set additional emergency stop switch, otherwise, personal injuries may be caused.
7. The temperature of cooling fin and direct current reactor can be very high, therefore, do not touch them, in case of the danger of burns.

1.2.4 Safety caution for maintenance check

1. Maintenance operations of overhaul and device replacement only can be done by trained professional maintenance staff. During operation, insulation protection tools shall be applied. It is strictly prohibited to leave thrum and metal in the machine. Otherwise, there can be dangers of electric shock, fire, and personal and property damage.
2. After replacement of control board, corresponding parameters must be set before operation, otherwise, there can be danger of property damage.

1.3 Knowledge on operation

1.3.1 Application knowledge of driving general motor

1. The temperature when driving general motor applied with frequency converter can be a little higher than that of industrial frequency power. With long-term operation at low speed, the operation life of motor can be affected due to the poorer heat dissipation effect. In this case, special frequency converter shall be selected or lighten the motor load.
2. If when the equipment is installed with frequency converter drive, sometimes, there can be resonance due to the natural vibration frequency of mechanical system, please consider about applying flexible coupling and insulation rubber, or applying the function of hopping frequency of the frequency converter, to avoid the resonance point for operation.
3. There can be larger noise when driving general motor applied with frequency converter than that of industrial frequency power. In order to reduce the noise, the carrier frequency can be increased properly.

1.3.2 Application knowledge of driving special motor

1. For high-speed motor, if the set frequency of frequency converter is above 120Hz, please conduct combination test with motor, to make sure it can be operated safely.
2. For synchronous motor, there must be correspondences according to the types of motor. Please contract the manufacturer for consultation.
3. Operation of single-phase motor is not applied with frequency converter. Even when input with single phase, there is three-phase output, please apply with three-phase motor.

1.3.3 Ambient environment

Application shall be applied in the indoor range with environment temperature of -10 to +45℃, humidity around 5~95% (without condensation of moisture), no dust, no direct sunlight, no corrosive gas, no combustible gas, no oil mist, no steam, no water or floating fiber or mental particles; if there is special requirements of clients, please contract the manufacturer for consultation.

1.3.4 Connection knowledge of peripheral equipment

1. For the protection of wirings, please configure breaker for wirings on the input side of frequency converter. Please do not apply device with larger capacity than recommendation.
2. If it needs to switch to industrial frequency power and others, when installing electromagnetic contactor on the output side of frequency converter, please switch after frequency converter and motor stop running.
3. When applying with motor thermal relay, if the wiring of motor is too long, sometimes it is affected

with the high-frequency current flowing through capacitance distributed with wiring, current below the set value of thermal relay may also cause trip. In this case, please lower the carrier frequency, or apply with output filter.

4. For noise interference, connection filter, magnet ring and shielded wire can be applied as corresponding measures.

1.3.5 Transportation and storage

1. During product handling, please capture the both sides of the bottom of the entity, rather than the cover or parts only.
2. Please do not make the parts of plastic excessive forced, otherwise, there can be falling down or damage.
3. When it is for temporary storage and long-term storage, pay attention to the followings:
 - Try to be packaged in the packing case of our company as the original package for storage.
 - Long-term of storage will lead to the characteristics of electrolytic capacitor worsen, therefore, it shall be powered on every half year at least, and with conduction time more than half an hour, and the input voltage must be risen to the rated value gradually with voltage regulator.

1.4 Abandon caution

1. Explosion of the electrolytic capacitor: electrolytic capacitor in the frequency converter may cause explosion while burning.
2. Waste gas of plastic burning: harmful and toxic gas may be produces while burning the plastic and rubber product of the frequency converter.
3. Disposal methods: please deal with the frequency converter as industrial waste.

1.5 Other cautions

1. This product shall not be applied for life support device and other application concerning directly with human body safety, otherwise, there can be accident.
2. If serious accident or serious losses caused due to the failure of this product, please install safety device for this product, otherwise, there can be accident.

Chapter 2 Product Introduction

2.1 Model description

V350 - 4 T 0090

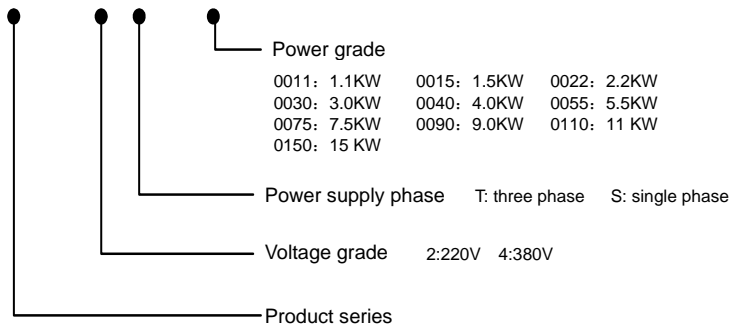

V350: Low-power closed-loop vector inverter
 A510: Heavy-load closed-loop vector inverter
 E380: Universal inverter

V560: High-performance closed-loop vector inverter
 E550: Low-power universal inverter

2.2 Product appearance

Appearance of Category I Applicable for: V350-4T0030/2S0022 and below models

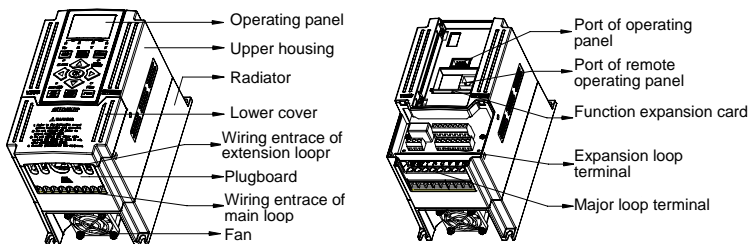

Appearance of Category II Applicable for: V350-4T0040 and above models

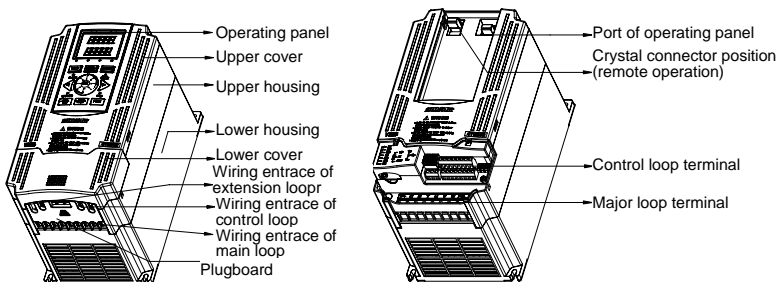

2.3 Model table

Voltage grade	Model	Rated capacity (KVA)	Suitable motor (KW)	Rated current (A)
Single-phase 220V	V350-2S0007	1.9	0.75	5.0
	V350-2S0011	2.5	1.1	6.5
	V350-2S0015	2.9	1.5	7.5
	V350-2S0022	3.8	2.2	10.0
Three-phase 380V	V350-4T0011	2.0	1.1	3.0
	V350-4T0015	2.4	1.5	3.7
	V350-4T0022	3.6	2.2	5.5
	V350-4T0030	4.9	3.0	7.5
	V350-4T0040	6.3	4.0	9.5
	V350-4T0055	8.6	5.5	13.0
	V350-4T0075	11.2	7.5	17.0
	V350-4T0090	13.8	9.0	21
	V350-4T0110	16.5	11	25
V350-4T0150	21.7	15	33	

2.4 Product technical index and specifications

Input Output	Rated voltage, frequency	Three phase (4T# series) 380V 50/60Hz	Single phase (2S# series) 220V 50/60Hz
	Output voltage	0~380 V	0~220 V
	Output frequency	Low-frequency running mode: 0.00~300.00Hz; High-frequency running mode: 0.00~1000.00Hz	
	Digital input	<ul style="list-style-type: none"> Models V350-4T0030/2S0022 and below: standard configuration of 5-circuit digital input (DI) Models V350-4T0040 and above: 6-circuit digital input (DI), extensible to 16-circuit (optional extension components) 	
	Digital output	<ul style="list-style-type: none"> Models V350-4T0030/2S0022 and below: standard configuration of 1-circuit digital output (DO) Models V350-4T0040 and above: standard configuration of 2-circuit digital output (DO) 	
	Pulse input	0 ~ 100.0KHz pulse input, to connect NPN type OC output (optional)	
	Pulse output	0 ~ 100.0KHz pulse NPN type OC output (optional); I PWM output mode can be selected to extend analog output terminal.	
	Analog input	Standard configuration: 0-10V voltage input (AI1); 0 - 20mA current input (AI2) Standard expansion I/O card: -10V - 10V voltage input	
	Analog output	<ul style="list-style-type: none"> Models V350-4T0030/2S0022 and below: 1-circuit 0-10V analog output signal(can be set to 0-20VmA current output mode) Models V350-4T0040 and above: 2-circuit 0-10V analog output signal(can be set to 0-20VmA current output mode) 	
	Contact output	Standard one group of AC 250V/2A normally open and closed contacts, extensible to 1-6 groups of normally open and closed contacts.	

Control Characteristics	Control Mode	Closed-loop vector control	Open-loop vector control	V/F control
	Starting torque	0 speed 200%	0 speed 180%	0 speed 180%
	Speed adjusting range	1: 1000	1: 200	1: 100
	Steady speed precision	±0.02%	±0.2%	±0.5%
	Torque control precision	±5%	±5%	--
	Torque response time	≅ 5ms	≅ 25ms	--
	Frequency resolution	Low-frequency running mode: 0.01Hz High-frequency running mode: 0.1Hz		
	Frequency precision	<ul style="list-style-type: none"> Low-frequency running mode: digital setting—0.01Hz, analog setting—maximum frequency ×0.1% High-frequency running mode: digital setting—0.1Hz, analog setting—maximum frequency ×0.1% 		
	Load capacity	110%-- long term ; 150%--60s; 180%--2.5s		
	Carrier frequency	<ul style="list-style-type: none"> three-phase voltage vector composition mode: 1.5~10.0KHz; two-phase voltage vector composition mode: 1.5~12.5KHz 		
	Deceleration and acceleration time	0.01~600.00Sec. / 0.01~600.0Min.		
	Magnetic flux brake	Achieve rapid retarding brake of the motor by increasing the motor's magnetic flux (30-120% allowed)		
	DC brake/band-type rake	DC brake/band-type brake initial frequency: 0.0 - upper limiting frequency, brake/band-type brake injection current 0.0 - 100.0%		
Strike frequency	0.0~50.0Hz			
Typical Function	Multi-segment running	16-segment frequency/speed running, independent setting of the running direction, time and acceleration & deceleration of each segment; 7-segment process PID setting		
	Built-in PID	Built-in PID controller, can be used independently by external equipment		
	Wakening and sleeping	Built-in PID, with simple sleeping and wakening functions.		
	MODBUS communication	Standard MODBUS communication protocol (optional) allowing for flexible parameter reading and mapping.		
	Dynamic braking	Actuating voltage: 700 - 760V, braking ratio: 50 - 100%		
	General Functions	Power-off restart, fault self-recovery, motor parameter dynamic/static self-identification. Start enabling, operation enabling, start delay, overcurrent suppression, overvoltage/undervoltage suppression, V/F custom curve, analog input curve correction, line brake detection, textile machinery disturbance (frequency swing) operation.		

Special Function	Virtual IO terminal	8-circuit one-to-one virtual output and input terminals, allowing for complicated engineering onsite application in an easy way without external wiring.
	Communication linkage synchronization	Easily allows for synchronized drive of multiple motors, and free selection of linkage balance of multiple motors based on current, torque and power.
	Load dynamic balance	Also allows for dynamic balance of multi-motor load (not limited to communication linkage) and able to achieve torque motor characteristics.
	Strong starting torque	For load featuring high inertia and high static friction, super strong starting torque for certain period can be set.
	Setting priority	Users can freely select the priority of various frequency/revolution setting channels; suitable for combined application for various occasions.
	Setting combinations	Up to hundreds of setting combinations of frequency, revolution and torque
	Timer	3 built-in timers: 5 kinds of clock, 5 kinds of trigger modes, multiple door access signals and working modes, and 7 kinds of output signals.
	Counter	2 built-in counters: clock margin selection, 4 kinds of trigger modes and 7 kinds of output signal
	Macro parameter	Application macro: Allowing for conveniently setting and partially curing multiple common group parameters and simplifying parameter setting for common applications.
		System macro: Allowing for conveniently switching equipment's working mode (e.g. switching between high and low frequency running modes), and automatically redefining local parameters.
	Parameter adjusting	Any un-stored parameter adjusted on site can be stored or abandoned and restored to original value with one key.
	Parameter display	Allowing for automatically shielding parameters of unused functional modules or selectively displaying modified, stored or changed parameters.

Protection Function	Equipment abnormality	Current detected abnormality, EEPROM memory abnormality, abnormal control unit, motor overtemperature and temperature acquisition loop fault.
	Power supply	Undervoltage protection and three-phase power supply unbalancing protection.
	Running protection	Overcurrent protection, overvoltage protection, inverter overtemperature protection, inverter overload protection, motor overload protection, output phase lack protection, and IGBT drive protection.
	Equipment abnormality	Current detected abnormality, EEPROM memory abnormality, abnormal control unit, motor overtemperature and temperature acquisition loop fault.
	Motor connection	Motor not connected, motor's three-phased parameters unbalanced and parameter misidentification.
	Extension card	Detect and protect the extension card for compatibility or conflict.
Environment	Installation environment	Indoor vertical installation, not subjecting to direct sunshine, free of dust, corrosive and flammable gas, oil mist, vapor and free of drips or salt.
	Altitude	0-1000 m. The output current capability drops by 10% for every rise of 1000 m.
	Ambient temperature	Working ambient temperature: -10°C - +45°C ; storage ambient temperature: -20°C - +60°C
	Humidity	95% below, no condensed water
	Ventilation	< 6m/s ²

Chapter 3 Installation Of Frequency Inverter

3.1 Installation of frequency inverter

This series of frequency inverters are wall-mounted frequency inverters, which should be installed vertically. In order to be in favor of circulation and heat dissipation, please install the frequency inverter at indoor place with good ventilation. Please refer to 1.3.3 for installation environment. If there is special installation requirement from customer, please contact the manufacturer in advance.

- **Mounting surface**

The temperature of cooling fin may rise to around 90℃, so please install the mounting surface at the place which can stand for this temperature rise.

- **Installation space**

Requirements for installation spacing distance of single frequency inverter are as shown in figure 3-1. Reserve enough space around the frequency inverter.

- **Multiple installations**

If install more than 2 sets of frequency inverters in device or control cabinet, please conduct parallel installation in principle as shown in figure 3-3. If there is no choice but vertical installation, please consider setting partition plate as shown in figure 3-2, to ensure no influence on upper frequency inverter from lower frequency inverter.

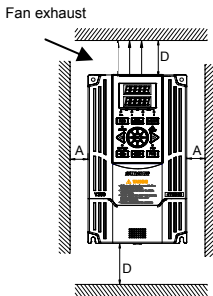

Figure 3-1 Spacing distance for installation

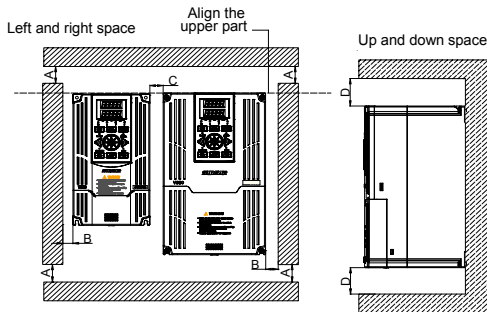

Figure 3-2 Left and Right Installation Size of Two Inverters (4.0KW above)



- As shown in Figure 3-1 and 3-2: $A \geq 50\text{mm}$, $B \geq 30\text{mm}$, $C \geq 20\text{mm}$, $D \geq 120\text{mm}$
- When horizontally and closely installed under 4.0KW, the ambient temperature is -10°C - 45°C .
- Horizontally close installation is only for 4.0KW below, and -10°C - 45°C environmental temperature.
- For parallel installation of frequency inverters with different sizes, please carry out installation after aligning the upper parts of all the frequency inverters, thus to be in favor of changing cooling fan.
- Please don't install frequency inverter in the environment with tattered cotton yarn and damp dust which may cause blockage of cooling fin. If necessary to operate in such environment, please install in the control cabinet which can keep tattered cotton yarn out.
- If necessary to install at the place with more than 1000m height above sea level, please derate operation. See 2.4 product technical indexes and specifications for details.

3.2 Size and assembly of operation panel

The operating panel name, mode, code and applicable device models of V350 series inverters are shown in Table 3-1.

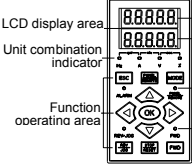
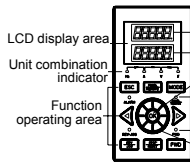
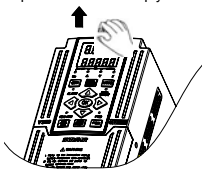
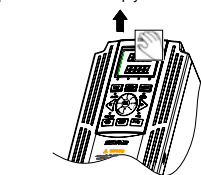
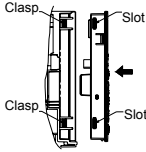
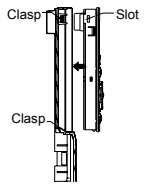
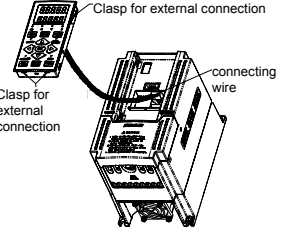
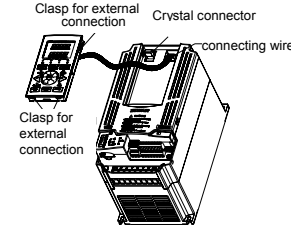
Name	Two-line LED small panel	Two-line LED standard operating panel
Model	DPNL350EM	DPNL360EB
Code	050M007033701	050M007360004
Applicable models	V350-4T0030/2S0022 and below models	V350-4T0040 and above models
Appearance		
Disassembling	<p>Put fingers on the slot at front part of the panel and then simply raise the panel</p> 	<p>Put fingers on the slot at front part of the panel and then simply raise the panel.</p> 
Installation	<p>After aligning the panel with the panel slot, press down the panel evenly.</p> 	<p>After aligning fixed hook month at the bottom of the panel with the clasp under the panel base, simply press down the top of the panel.</p> 
Prolonged external connection	<p>Remove the operating panel and make connection with the extension cable as shown in following figure.</p> 	<p>Remove the operating panel and detach the crystal connector and place it at specified position to avoid loss, and then use extension cable to make connection as shown in following figure.</p> 



- It is a must to use extension cable or commercial LAN cable (straight cables) in the market.
- Extension cable shall not exceed 15 meters; shielding layer is connected with grounding terminal of frequency inverter. Please select remote operation panel if the extension cable is more than 15 meters long.
- Do not carry out wiring horizontally close to the power line.
- Panel shall be fastened on stable fixed surface or work bench so as to avoid damage.

3.3 Installation size of the panel (the operating panel can be flexibly selected according to actual installation requirement)

Name	Two-line LED small panel	Two-line LED standard operating panel
Applicable Models	Standard configuration for V350-4T0030/2S0022 and below models	Standard configuration for V350-4T0040 and above models
Installation size		
External connection without tray, installation board hole diagram	<p style="text-align: center;">102*52</p> <p style="text-align: right;">Installation board</p>	<p style="text-align: center;">127*67</p> <p style="text-align: right;">Installation board</p>

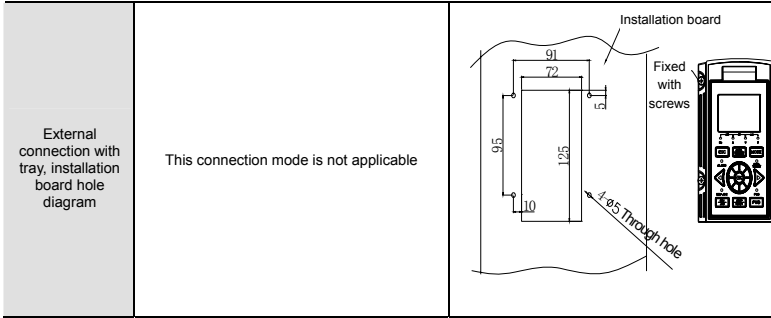

3.4 Removal of terminal cover

Removal: put fingers on the handle slot at the bottom of cover plate (the position of clasp as figure 3-7), and forcibly lift it upward until the card clasps between cover plate and shell break away, then pull the cover plate down can disassemble the shell. See figure 3-7

Installation: slant cover plate into about 15°, then insert the fixed stator at the top of cover plate into fixed slot on shell. Forcibly press the cover plate down until heard a click, which means the cover plate has been in place.

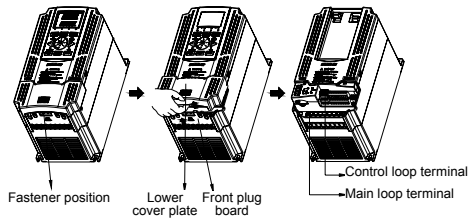
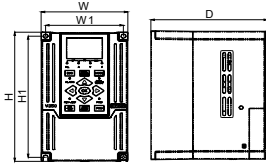

Figure 3-7 Disassembly and installation schematic diagram of plastic cover

3.5 Installation size of inverters

V350-4T0030/2S0022 and below models

W1: Distance between installation holes on the side board
 W: Side board width
 H1: Distance between installation holes on the side board
 H: Side board height
 D: Distance between front and rear boards



V350-4T0040 and above models

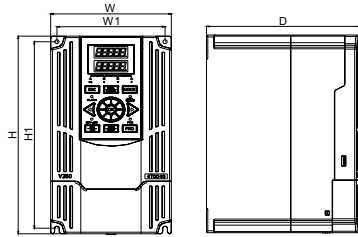

The inverter's installation size is shown as below:

Inverter Model Three-phase 380V	Inverter Model Three-phase 220V	W1 (mm)	W (mm)	H1 (mm)	H (mm)	D (mm)	Screw specification
V350-4T0011	V350-2S0007	87	97	152	162	130	M4
V350-4T0015	V350-2S0011						
V350-4T0022	V350-2S0015	95	105	190	200	145	M4
V350-4T0030	V350-2S0022						
V350-4T0040	-	121	135	234	248	175	M4
V350-4T0055	-						
V350-4T0075	-	146	160	261	275	179	M5
V350-4T0090	-						
V350-4T0110	-	169	180	290	305	179	M5
V350-4T0150	-						

Chapter 4 Wiring Of Frequency Inverter

4.1 Wiring precautions

- Make sure intermediate circuit breaker is connected between the frequency inverter and power supply to avoid expanded accident when the frequency inverter is faulty.
- In order to reduce electromagnetic interference, please connect surge absorber on the coil of electromagnetic contactor, relay and etc. in the surrounding circuit of the frequency inverter.
- Please use shielded wire of above 0.3mm^2 for the wiring of such analog signals as frequency setting terminal and instrument loop, etc. The shielding layer shall be connected on the grounding terminal of the frequency inverter (keep the shielding layer earthed at single end) with wiring length less than 30m.
- The stranded wire or shielded wire of above 0.75mm^2 shall be selected for the wiring of input and output loop of relay.
- The control wire shall be separated from the power line of major loop; it shall be at a distance of above 10cm for parallel wiring and vertical for cross wiring.
- All the leading wires shall be completely fastened with the terminal to ensure good contact. The leading wires of major loop shall be adopted cables or copper bar. When using cables, wiring must not be carried out until they are cold pressed or welded well by lug plate with corresponding section.
- The pressurization of all the leading wires shall be in compliance with the voltage class of the frequency inverter.
- Please reliably ground the frequency inverter and motor locally.



Absorption capacitor or other RC absorbers shall not be installed at U, V and W output end of the frequency inverter, as shown in figure 4-1.

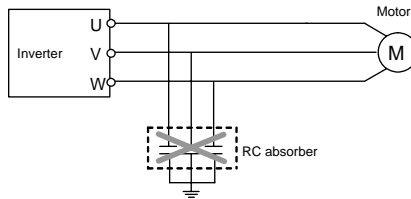

Figure 4-1 The ketch of forbidding connecting a RC absorber at the output terminal

4.2 Connection of optional fittings and frequency inverter

- Power supply

The power supply shall be in accordance with the specification of input power supply designated by this operating manual.

- Air switch

- 1) When the frequency inverter is maintained or not in use for a long time, the air switch will separate the frequency inverter from the power supply;
- 2) When the input side of the frequency inverter has failures like short circuit, the air switch can protect.

- AC input reactor

When the interaction of higher harmonic between the frequency inverter and power supply can not meet the requirements after serious wave form distortion of power grid or the frequency inverter is equipped with DC reactor, the AC input reactor can be added. The AC input reactor can improve the power factors at input side of the inverter and reduce the influence caused by unbalanced voltage of three-phase power supply.

- Filter at input side

EMI filter can be selected to restrict the high-frequency noise interference from the power cord of the frequency inverter.

- Contactor

It can cut off the power supply when the system protective function acts to prevent failure expanding.

- DC reactor:

In order to defend the influence of power supply to frequency inverter, protect the inverter and restrict higher harmonic, DC reactor shall be equipped under the following conditions:

1) When the power supply of frequency inverter has switch LBMJ on the node or with silicon controlled phase control load, the voltage jump of the grid resulted from reactive transient caused by capacitor switching and harmonic and grid wave form gap caused by phase control load may damage the input rectifying circuit of the frequency inverter.

2) When the three-phase power supply of the frequency inverter is unbalanced;

3) When the power factors at the input end of the frequency inverter are required to improve.

- **Filter at output side**

EMI filter can be selected to restrict the interference noise generated at the output side of the inverter and wire leakage current.

- **AC output reactor**

When the wiring from the frequency inverter to the motor is longer (exceeding 20m), it can restrict radio interference and leakage current.

- **Braking resistor**

Improve the braking capacity of frequency inverter to avoid overvoltage failure when slowing down

The specification of recommended electric appliances is as follows:

Model of frequency inverter	Adaptive motor (KW)	Wire gauge (major loop) (mm ²)	Air circuit breaker (A)	Electromagnetic contactor (A)	screw specification	tightening torque (N*m)	Recommended lug model no
V350-2S0007	0.75	1.5	10	9	M3.5	0.7~0.9	PTV2-9
V350-2S0011	1.1	2.5	16	12	M3.5	0.7~0.9	PTV2-9
V350-2S0015	1.5	4	20	16	M3.5	0.7~0.9	PTV5.5-13
V350-2S0022	2.2	6	32	22	M3.5	0.7~0.9	PTV5.5-13
V350-4T0011	1.1	1.5	16	12	M3.5	0.7~0.9	PTV1.25-9
V350-4T0015	1.5	2.5	16	12	M3.5	0.7~0.9	PTV1.25-9
V350-4T0022	2.2	4	16	12	M3.5	0.7~0.9	PTV2-9
V350-4T0030	3.0	4	20	16	M3.5	0.7~0.9	PTV2-9
V350-4T0040	4.0	4	25	16	M4	1.2~1.5	RNY2-4S
V350-4T0055	5.5	6	32	22	M4	1.2~1.5	RNY5.5-4S
V350-4T0075	7.5	6	40	32	M4	1.2~1.5	RNY5.5-4S
V350-4T0090	9.0	10	50	32	M4	1.2~1.5	RNY5.5-4S
V350-4T0110	11	10	63	32	M4	1.2~1.5	RNY5.5-4S
V350-4T0150	15	10	63	38	M4	1.2~1.5	RNY8-5S

General control board/extension card connection terminal			
General control terminal	Screw specification	Tightening	Recommended lug model no
control board/extension card terminal	M2	0.1~0.2	E0.5-6
control board/extension card terminal	M3	0.3~0.4	E0.75-6

Lug model no		d2(mm)	W(mm)	F(mm)	L(mm)	H(mm)	d1(mm)	D(mm)	T(mm)
RNY series	RNY2-4S	4.3	6.6	7.9	22.2	11	2.3	4.8	0.8
	RNY5.5-4S	4.3	7.2	5.9	22.5	13	3.4	6.7	1
	RNY8-5S	5.3	8.8	9.3	29.7	16	4.5	8	1.2

Lug model no		W(mm)	F(mm)	L(mm)	H(mm)	d1(mm)	D(mm)	T(mm)
PVT/E series	PTV1.25-9	1.9	9	19	10	1.7	4.2	0.8
	PTV2-9	1.9	9	19	10	2.3	4.7	0.8
	PTV5.5-13	2.8	13	26	13	3.4	6.5	1
	E0.5-6	1.1	6	12	6	1	2.6	/
	E0.75-6	1.1	6	12.3	6.3	1.2	2.8	/

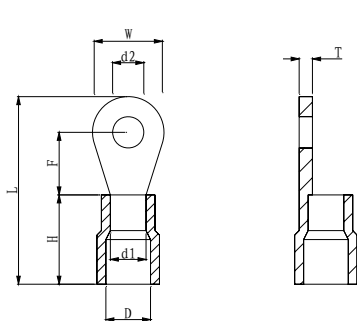

RNY series

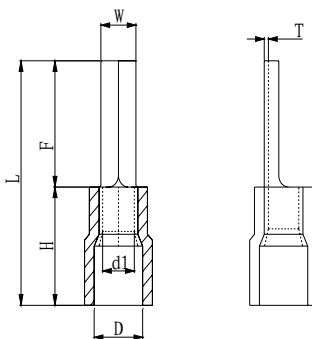

PVT/E series

4.3 Wiring of control terminals

4.3.1 Wiring of standard terminals of control panel

Category I: CON3 and CON4 terminals

Applicable to: V350-4T0030/2S0022 and below models

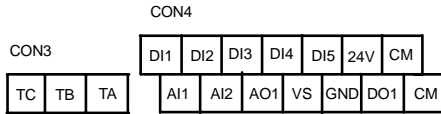

Category II: CON1 and CON2

Applicable to: V350-4T0040 and above models

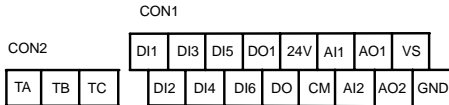

4.3.2 Function description of control terminal

Type	Label of terminal	Name	Function description of terminals	Specification
Control terminal	DI1-CM	Multifunctional output terminal DI1	6-circuit programmable switching value input terminal, allowing for selection of 98 kinds of operational control commands via programming offunction codes in F3.0 group. See Comparison Table of Multifunctional Output Terminal Functions for details (page P67).	Opto-isolated inputs: 24Vdc/5mA Gate voltage<16V bandwidth<1MHZ
	DI2-CM	Multifunctional output terminal DI2		
	DI3-CM	Multifunctional output terminal DI3		
	DI4-CM	Multifunctional output terminal DI4		
	DI5-CM	Multifunctional output terminal DI5		
	DI6-CM	Multifunctional output terminal DI6		
Operating status output	CM	Input/output terminal common port	2-circuit programmable open-circuit collector output and 1-circuit programmable relay output terminal; 63 kinds of operating status output can be selected by the function code in F3.1 group by programming. See <i>Comparison Table for Variables of Multifunctional Output Terminal</i> for detail (page 68).	Maximum load current: 150mA, highest withstand voltage: 24V
	DO1-CM	Multifunctional output terminal DO1		
	DO2-CM	Multifunctional output terminal DO2		
	TA	Multifunctional relay output RO1		Contact capacity: AC 250V/2A
	TB	TA-TB normally closed		
TC	TA-TC normally open			
Power supply	CM	+24V power supply reference place	Power supply of switching value terminal	Maximum output current: 100mA
	24V	+24V power supply		

Type	Label of terminal	Name	Function description of terminals	Specification
Analog input	AI1-GND	Analog input AI1	Select input voltage range, polarity and other functions with function code in F4 group.	Input voltage: 0~10V, Input current: 0~20mA input impedance: 100K
	AI2-GND	Analog input AI2		
Analog output	AO1-GND	Multifunctional analog outputAO1	The programmable voltage/current signal output terminal has 45 kinds of monitoring status to be selected by programming. See <i>Comparison Table for Monitor Variables</i> for details. For JP1, current/voltage output is selected (see <i>DIP Switch Jumper Selection</i> in 4.3.3 for detail)	Current input: 0~20mA, voltage input : 0~10V output current capacity impedance specification: 0~300 Ω
	AO2-GND	Multifunctional analog outputAO2		
Power supply	GND	Common terminal of analog signal	Provide externally +10V/10mA power supply or +5V/50mA power supply.	JP3 (see DIP Switch Jumper Selection in 4.3.3 for detail) selection
	VS-GND	+10V/5V power supply		

4.3.3 Description of dial switch on the control panel

1. There are two shifts for one dial switch.

Applicable model: V350-4T0030/2S0022 and below models

JP3

Shift V: Indicating that AO terminal externally outputs 0~10V voltage signal

Shift A: indicating that AO terminal provides externally 0~20mA current signal.

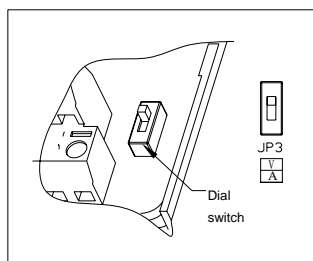

2. There 3 shifts for three dial switches.

Applicable mode: V350-4T0040 and above models.

JP1

Shift VO1: Indicating that AO1 terminal outputs voltage signal.

Shift OFF: Indicating that AO1 terminal is at vacant state.

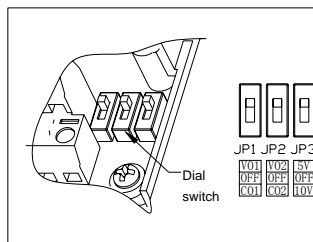

Shift CO1: Indicating that AO1 outputs current signal.

JP2

Shift VO2: Indicating that AO2 terminal outputs voltage signal.

Shift OFF: Indicating that AO2 terminal is at vacant state.

Shift CO1: Indicating that AO2 outputs current signal.

JP3

Shift 5 V: Indicating that VS terminal provides externally 5V voltage signal.

Shift OFF: Indicating that VS terminal is at vacant state.

Shift 10V: Indicating that VS terminal provides externally 10V voltage signal.

4.4 Wiring of major loop terminal

4.4.1 Terminal Functions

Symbol	Function description	Symbol	Function description
P+	DC side voltage positive terminal	P	DC electric reactor can be connected between P+ and PB.
P-	DC side voltage negative terminal, Bus voltage input terminal of DC braking unit can be connected between P+ and P-.	PB	DC braking resistance can be connected between P+ and PB.
R、S、T	Connect three-phase AC power supply of grid	U、V、W	Connect three-phase AC motor
E	Earthing terminal	--	--

4.4.2 Main loop terminal diagram

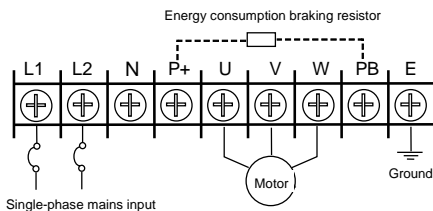

Category I main loop terminal

Applicable model:

V350-2S0007~V350-2S0011

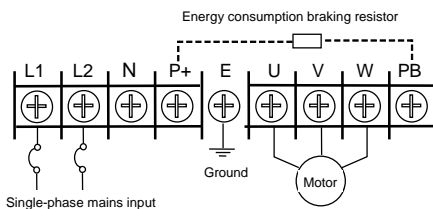

Category II main loop terminal

Applicable model:

V350-2S0015~V350-2S0022

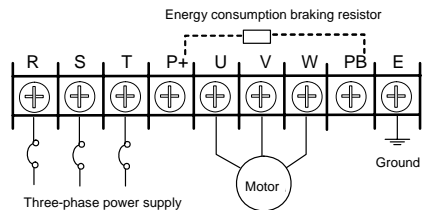

Category III main loop terminal

Applicable model:

V350-4T0011~V350-4T0015

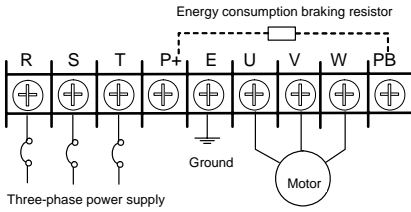

Category IV main loop terminal

Applicable model:

V350-4T0022~V350-4T0030

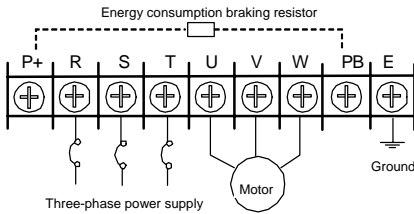

Category V main loop terminal

Applicable model:

V350-4T0040~V350-4T0055

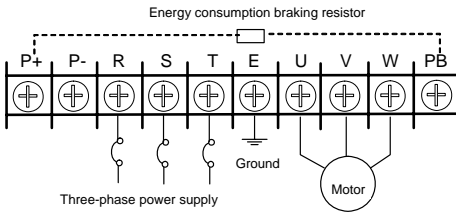

Category VI main loop terminal

Applicable model:

V350-4T0075~V350-4T0150

4.5 Wiring for basic operation of inverters

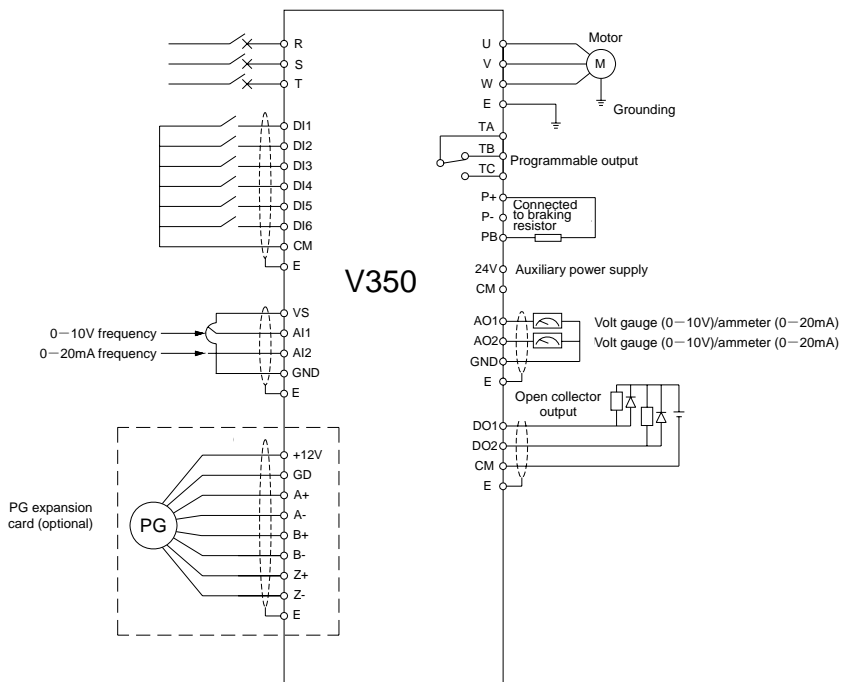

Figure 4-2 Basic Wiring Diagram of V350 Series Inverters

Chapter 5

Operation And Simple Running Of Frequency Inverter

5.1 Basic function of the panel

The panel of the frequency inverter mainly has two functions apart of basic starting and stopping control: monitoring of parameters for operating status and query and modification of internal parameters. Accordingly, the operation panel is divided into two operating modes: monitoring mode and parameter modification/query mode.

At the beginning of energizing, the main display column presets "sunfr" static display characters and shifts out "sunfr" characters from right to left and recovers normal display about 3 seconds later. At the same time, the auxiliary display column displays the serial number of the frequency inverter statically such as "V-350" and displays the model information of the frequency inverter except "T, S" 3 seconds later such as "4.0037" and displays normally 3 seconds later. At this time, the operating parameters displayed in the operation panel are determined by the internal parameters of the frequency inverter [F0.0.12], [F0.0.13]. The operation panel will return normal monitoring mode at any status if there is no keying operation within 1 minute. (See Chapter 3 for the appearance of the operation panel).

5.1.1 Panel description

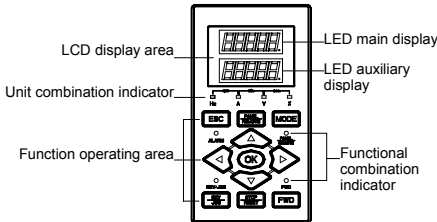

Figure 4-1-A Two-Line LED Small Panel Standard configuration for V350-4T0030/2S0022 and below models

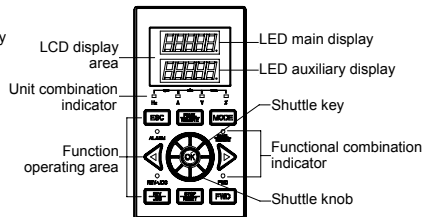













Figure 4-1-B Two-Line LED Standard Operating Panel Standard Configuration for V350-4T0040 and above models

Table 5-1 Functions of keys

Item	Functions
Main digital display	Display the current operating status parameters and setting parameters of the frequency inverter.
Auxiliary digital display	Display the current operating status parameters and setting parameters of the frequency inverter
A, Hz, V, %	A, HZ, V displays the corresponding measurement unit of the data of the main digital display. % displays compound unit The compound unit indicator is defined as follows: Hz+A = RPM; V+% = Sec. ; A + V = Min
FWD, REV	Indicator for operating status , its flicker shows the frequency inverter is in F/R operation and has voltage output.
PANEL/REM OTE	The indicator is off: the external terminal command is valid; the indicator is on: the operation panel command is valid; the indicator is flashing: the communication interface (or expanded communication board or expanded function board) command is valid.
ALARM	Alarm indicator: The indicator is on: the frequency inverter is in warning status. It shall check up and eliminate abnormalities; otherwise, the frequency inverter may be faulty and shut down.
	Forward operation command key Press this key to send forward operation command when the operation command channel of the frequency inverter is set as operation panel control ([F0.3.33] or [F0.3.34]=0)
	Reverse/inching operation command key Press this key to send reverse operation command when the reverse function ([FF.4.42=# # # 0]) is selected and the operation command channel of the frequency inverter is set as operation panel control ([F0.3.33] or [F0.3.34]=0); and press this key to send inching operation command when inching function ([FF.4.42=# # # 1]) is selected.
	Stop/reset key When this key is pressed in operating status, the frequency inverter will shut down as per set mode; and when pressing this key in fault conditions, the frequency inverter will reset and return to normal stopped status.  Keys can be locked or functions can be changed by users (refer to Functional Parameter F0.011).
	Return key At any status, it will return to the status of last level till normal monitoring mode by pressing this key.
	Mode key Switch display function parameter set and monitoring parameter set in parameter modification status. The corresponding "EROM stored value", "value at this time of energizing" and "panel backup value" of the current function code will be displayed at auxiliary display column in turn by pressing this key.
	Left shift key The modified data bit can be selected from right to left by pressing this key and the modified bit has flicker display.
	Right shift key The modified data bit can be selected from left to right by pressing this key and the modified bit has flicker display.

Item	Functions
	<p>Data modification key Used to modify function code or parameter. If digital setting mode is set currently, the digital setting value can be modified directly by using this key in normal monitoring mode.</p>
	<p>Local, terminal and communication control function switch key The keyboard control, external terminal control and communication control functions can be switched with each other through setting [F0.0.11]=##1## (the switch status is not stored and lost after power down).</p>
	<p>Shuttle selection key Adjust data after addition in clockwise rotation and adjust data after subtraction in counterclockwise rotation. When [F0.0.25]=3, select panel shuttle setting.</p>
	<p>Ok key Confirm the current status and parameters (the parameters are stored in the internal memory) and enter into next-level function menu.</p>

5.2 Basic functions and operating methods of panel

5.2.1 Basic functions of panel

The operation panel also has the following special functions aside from such basic functions as forward operation, reverse operation, inching operation, shut down, fault reset, parameter modification and inquiry and operating status parameter monitoring, etc.

Parameter copy and read/backup (parameter upload)

This operation panel allows for copying the internal parameters of the frequency inverter to the operation panel (only the internal parameters opened to users) and storing permanently. Therefore, users can backup their typical setting parameters to the operation panel for emergency. The backup parameters in the operation panel do not influence the operation of the frequency inverter and can be checked and modified separately.

When [F0.0.08]=####1, the keyboard will begin to read the internal parameters of the frequency inverter and the operation panel will display the process of reading parameters in real time. After the completion of parameter backup, the display mode will recover to normal monitoring automatically. During parameter backup, the operation can be stopped at any time by pressing  key and the display will switch to normal monitoring mode. If alarm information is occurred, please refer to Chapter 8.

Parameter copy/write in (parameter download)

This operation panel allows for copying the backup parameters to the internal memory of the frequency inverter (only the internal parameters opened to users) and users can write in their typical setting parameters backed up in the operation panel into the frequency inverter at one time without separate modification.



When the frequency inverter set F0.0.08 as ## 1 2 or ## 1 3 in stopped mode, the keyboard will begin to copy the backup parameters to frequency inverter and the operation panel will display the process in real time. After the completion of copying, the display mode will recover to normal monitoring automatically.

During parameter copying, the operation can be stopped at any time to abandon the copied parameters by pressing  key and the display mode will switch to normal monitoring mode. If alarm information is occurred, please refer to Chapter 8.

Check and modification of internal parameters



In normal monitoring mode, the internal parameters of the frequency inverter can be checked and modified as per general methods by pressing  key.

□ **Check and modification of panel backup parameters**

In normal monitoring mode, the backup parameters in the operation panel can be checked and modified by pressing  and  key simultaneously (double key compound use) and the high-order code “F” will display flickeringly when function code is displayed. The modification methods of backup parameters are the same as that of internal parameters.

□ **Locking and unlocking of panel**







1) Locking: part of or all the keying functions of the panel can be locked through setting the application parameter F0.0.11. If the parameter is set as panel locking mode, the panel will be locked immediately after the frequency inverter is energized.

2) Unlocking: the panel will be unlocked for 5 minutes temporarily by pressing  and maintaining and pressing  twice in order within 5 seconds and it will automatically recover to locking if there's no keying within 5 minutes.



To unlock the panel thoroughly, the panel locking parameter [F0.0.11] should be modified into “unlocked” status during the temporary unlock of the panel.

□  **Key function**

 key function is limited by the application parameter F0.0.11. In function enabling and “normal monitoring mode”, press  key to switch the operation command channel in order “operation panel → local terminal → communication interface → operation panel”.  indicator displays the selected command channel which will be valid by pressing  within 3 seconds. It will abandon the switch and return to original status by pressing  or without pressing  within 3 seconds.



When switching command channel, if the original setting is “operation panel” or “local terminal”, the “communication interface” will be defaulted as local MODBUS field bus.

The operation command channel switched by this function is not stored permanently. It will recover to original setting after the frequency inverter is power down and restarted. Relevant application parameters of the frequency inverter should be modified to permanently change the command channel.

5.2.2 Operating methods of panel

1) Query for status parameters (e.g.)

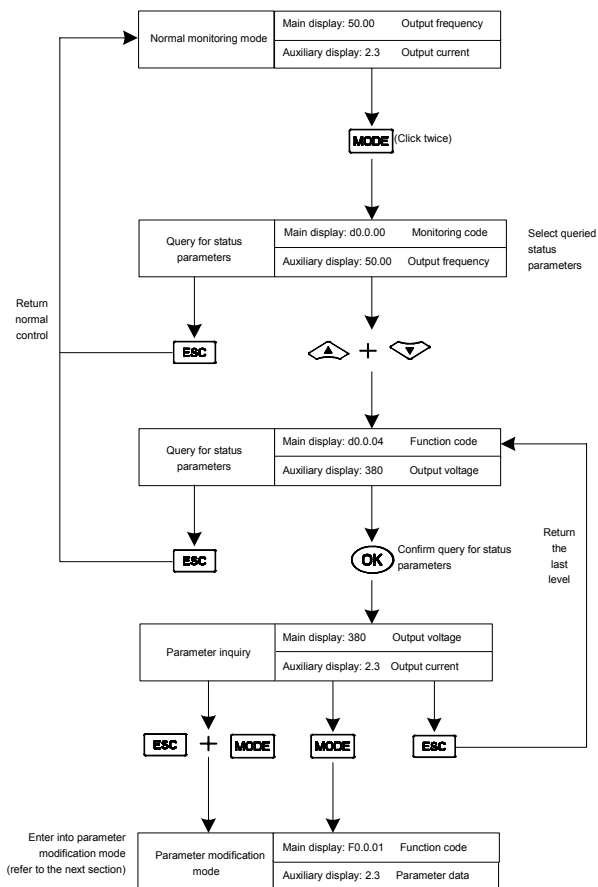

Figure 5-2 Query for status parameters

2) Parameter query and modification (e.g.)

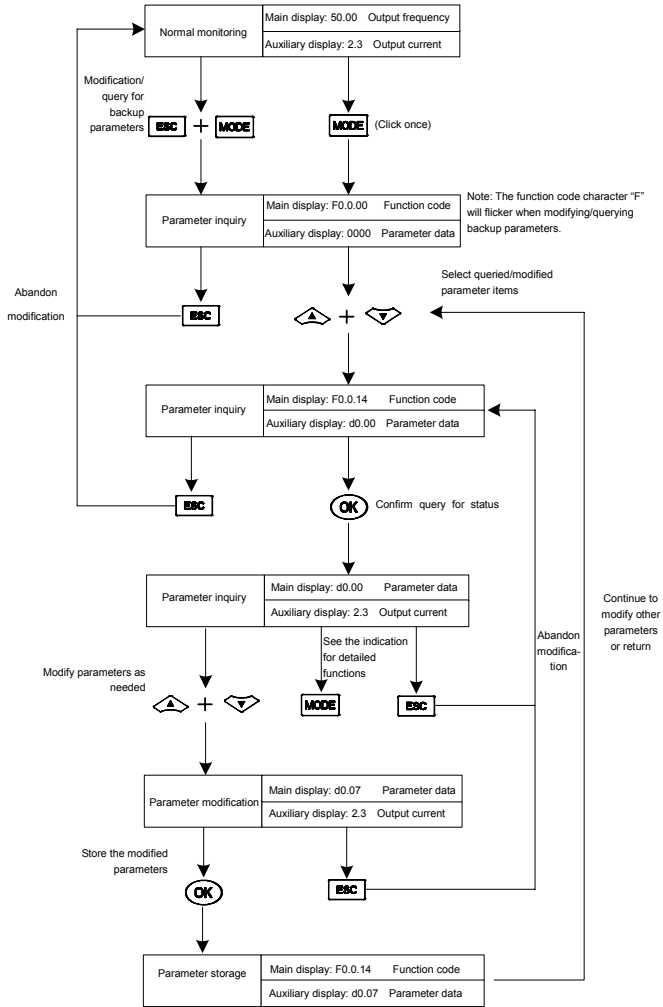



Figure 5-3 Parameter check and modification

Remark: in this status, the auxiliary display column will display the following in turn by pressing  key repeatedly. Default auxiliary monitoring parameters (original state) → EROM regional numerical value → parameter values at initial energizing → backup parameters in operation panel, the numerical value will flicker when “EROM regional numerical value”, “parameter values at initial energizing” and “backup parameters in operation panel” are displayed.

5.3 Simple running of frequency inverter

5.3.1 Initial settings

- Selection of control mode

V350 frequency inverter has three control modes: vector control without PG, vector control with PG and V/F control. The operation control mode is selected by the application parameter F0.0.09.

Mode 0: vector control without PG, i.e. vector control without velocity sensor, also called open loop vector control. It is applicable to the place where encoder is not installed, has higher requirement to starting torque and speed control precision and the normal V/F control mode can not satisfied.

Mode 1: vector control with PG, i.e. vector control with velocity sensor, also called closed loop vector control. It is applicable to the place where faster response of torque and higher control precision is required.

Mode 2: V/F control mode. Except normal V/F control application, it can also be applied to the place where the frequency inverter drives more than one motor.

The control modes of frequency inverter vary from the type and control requirements of motor and set by parameter F0.0.09=####. For instance, the field where three-phase asynchronous motor is used can be selected through setting F0.0.09=###0 and the field where the control precision is highly required with velocity sensor can be set to F0.0.09=##1# speed closed loop vector control mode.

- Selection of frequency input channel (F0.2.25)

V350 frequency inverter has 29 frequency setting modes for each of the channel.

- Operation command input channel [F0.3.33]

5.3.2 Simple operation

 It is absolutely forbidden to connect the power cord to the output U, V, W of the frequency inverter.

□ Simple wiring diagram

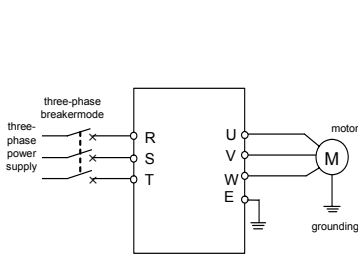

Figure 5-3 Wiring for the operation of SVC mode

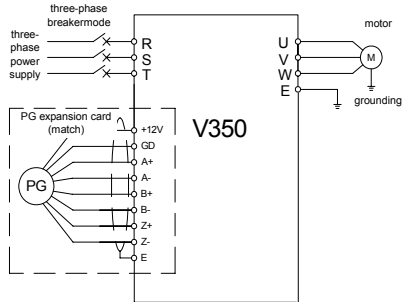

Figure 5-4 Wiring for the operation of VC mode



□ SVC (non-inductive vector) operation

Take 7.5KW frequency inverter which drives 7.5KW three-phase AC asynchronous motor as the example to indicate the operation process. The nameplate parameters of the motor are:

Rated power: 7.5KW	rated voltage: 380V	rated current: 15.4A
Rated frequency: 50.00HZ	rated speed: 1440rpm	pulse of encoder: 1000PPR

Use operation panel to conduct digital frequency setting and start-stop control.

1. Connect as per Figure 5-3;
2. Power on after making sure the wiring is correct;
3. Set parameters as follows:
 - [F0.0.09]=0000 (noninductive vector control)
 - [F0.0.00]=0001 (apply macroparameters, set as panel operation digital setting for shortcut)
 - [F2.0.00]=7.5 (rated power of motor)
 - [F2.0.01]=380 (rated voltage of motor)
 - [F2.0.02]=15.4 (rated current of motor)
 - [F2.0.03]=50.00 (rated frequency of motor)
 - [F2.0.04]=1440 (rated speed of motor)

4. Press  key to start frequency inverter. If the name plate parameters (F2.0.00 ~ F2.0.04) of the motor are modified in ③, the primary static parameter identification will be started automatically, the frequency inverter will output 0 frequency and the auxiliary display column will display the current output current (not limited by F0.0.13 at this time). When the display current is stable as 0.0, the automatic learning is finished and operation is started;
5. Press  key to increase set frequency, where the output frequency of the frequency inverter will be increased and the speed of motor will accelerate;
6. Observe the operation of motor, if there are abnormalities, stop it immediately and power off and re-operate it after finding out the causes;
7. Press Data Modification key to reduce set frequency;
8. Press  key to stop operation and cut off the power supply.

□ VC (inductive vector) operation

The following parameters also need to be set except the above set parameters required by SVC operation. The wiring diagram is as shown in figure 5-4.

- [F0.0.09]=0010 (inductive vector control)
 [F8.0.04]=0 (speed feedback channel)
 [F8.0.05]=1000 (pulse of encoder per revolution)
 [F8.0.06] If F/R periodic vibration is occurred in starting, this parameter shall be set as 1 (or exchange the wiring of A, B pulse); other operations are the same as that of SVC operation.



If the motor is completely empty-load, slight oscillation may occur sometimes in the operation under high carrier frequency. At this time, please reduce the setting value of the carrier frequency. (Parameter [F1.1.13]).

Chapter 6 Functional Parameter Table

Note:

"x": indicates that the set value of the parameter cannot be changed when the inverter is running.

"☆": indicates the parameter is relevant with the model of the inverter.

"R": indicates the parameter is just for reading and cannot be changed;

"R/I": indicates the parameter is just for reading and cannot be changed, but can be cleared by initialization.

"—": indicates the parameter is relevant with the type or status of connected accessories.

Variables: (H)-hexadecimal number; only bitwise data change is permitted (carry bit is not allowed), and the upper and lower limit for bitwise change.

6.1 System management parameter

Function Code	Name	Setting Range and Description	Factory Default	Minimum Unit	Change Limit
F0.0.00	Macro parameter (H)	<p>The unit: Application macro (0~F) 0: void (customized setting) 1: setting of panel operation digit (factory default) 2: setting of panel operation shuttle 3: Two-line control 1 (AT1 setting) 4: Two-line control 2 (AT1 setting) 5: Three-line control 1 (AT1 setting) 6: Tool device spindle drive (AT1 setting)</p> <p>Tens: reserved Hundreds: dedicated macro Kilobit: system macro (0~F) 0: standard operation 1: void (standard mode by default) 2. high-frequency output (0.0 ~ 1000.0Hz)</p>	0000	1	×
F0.0.01	Parameter display and modification (H)	<p>The unit: parameter display mode 0: Display all parameters 1: Display effective configuration parameters 2: Display parameters different from factory default 3: Display modified and stored parameters after power-on this time 4: Display modified and un-stored parameters after power-on this time</p> <p>Tens: parameter modification mode 0: Effective and permanently stored after modification 1: Effective after modification but not stored, and getting lost after power-off</p> <p>Hundreds: Reserved Kilobit: batch restoring and batch saving of parameters 2: Giving up modification of all unsaved parameters (restore to original value) 5: Batch saving of all modified and unsaved parameters 9: Restoring all parameters to initial values at the time of power-on this time.</p>	0001	1	
F0.0.02	Modification key for macro call parameters (system macro)	0~65535(1580)	0	1	×
F0.0.03	Reserve		-	-	-
F0.0.04		The unit: contrast 0~7	0023	1	-

Function Code	Name	Setting Range and Description	Factory Default	Minimum Unit	Change Limit
	LCD display setting (H)	Tens: normal display mode 0: Steady mode 1: Single parameter display 2: Dual parameter display 3: Three parameter display			
F0.0.05	Parameter locking (H)	The unit: parameter modification permission 0: All parameters are permitted to be modified 1: Except for this parameter, frequency digital setting, PID digital setting, revolution digital setting, torque digital setting, locking password parameter (F0.0.06), other parameters are forbidden to be modified. 2: All parameters are forbidden to be modified except for this parameter and the locking password. Tens: Coded lock 0: Void 1: Effective – once the password is set, this parameter cannot be modified unless correct password is entered.	0000	1	
F0.0.06	Parameter locking password	0~65535	0	1	
F0.0.07	Parameter initialization	0: No action 1: Parameters of F0~F9 groups are restored to the factory default. 2: Parameters of F0~FA groups are restored to the factory default. 3: Parameters of F0~Fb groups are restored to the factory default. 4: Parameters of F0~Fc groups are restored to the factory default. 5: Parameters of F0~Fd groups are restored to the factory default. 6: Parameters of F0~FE groups are restored to the factory default. 7: Parameters of F0~FF groups are restored to the factory default. 8: Clear away fault records	0	1	×
F0.0.08	Parameter copying (H)	The unit: Upload and download 0: No action 1: Parameter upload (inverter → panel) 2: Parameter download (panel → inverter) 3: Parameter download (except for motor parameter F2 group)	0000	1	×

Function Code	Name	Setting Range and Description	Factory Default	Minimum Unit	Change Limit
		Tens: Local download permitted 0: Parameter download forbidden 1: Parameter download permitted			
F0.0.09	Control mode selection	The unit: Reserved Tens: Control mode 0: SVC mode/open-loop vector control 1: VC mode/closed-loop vector control 2: V/F control	0000	1	×
F0.0.10	Reserved parameter				
F0.0.11	Selection of panel key functions (H)	The unit: Panel key locking 0: No locking 1: All keys are locked except for UP/DW (Shuttle), Stop and RUN. 2: All keys are locked except for STOP and RUN 3: All keys are locked except for STOP. 4: Lock all keys Tens: STOP key function 0: Non-panel control mode void 1: Press STOP key in any control mode to stop the device slowly 2: Press STOP key in any control mode to stop the device freely Hundreds: Function of PANEL/ REMOTE keys 0: Void 1: Stop effective 2: Continuously effective Kilobit: Reserved	0000	1	×
F0.0.12	Principal monitoring parameter (H)	d0.0~d0.55 / d1.0~d1.55	d0.00	1	
F0.0.13	Auxiliary monitoring parameter 1 (H)	d0.0~d0.55 / d1.0~d1.55	d0.02	1	
F0.0.14	Auxiliary monitoring parameter 2 (H)	d0.0~d0.55 / d1.0~d1.55	d0.04	1	
F0.0.06	Parameter locking password	0~65535	0	1	
F0.0.07	Parameter initialization	0: No action 1: Parameters of F0~F9 groups are restored to the factory default. 2: Parameters of F0~FA groups are restored to the factory default.	0	1	×

Function Code	Name	Setting Range and Description	Factory Default	Minimum Unit	Change Limit
		3: Parameters of F0~Fb groups are restored to the factory default. 4: Parameters of F0~Fc groups are restored to the factory default. 5: Parameters of F0~Fd groups are restored to the factory default. 6: Parameters of F0~FE groups are restored to the factory default. 7: Parameters of F0~FF groups are restored to the factory default. 8: Clear away fault records			
F0.0.08	Parameter copying (H)	The unit: Upload and download 0: No action 1: Parameter upload (inverter→ panel) 2: Parameter download (panel → inverter) 3: Parameter download (except for motor parameter F2 group) Tens: Local download permitted 0: Parameter download forbidden 1: Parameter download permitted	0000	1	×
F0.0.09	Control mode selection	The unit: Reserved Tens: Control mode 0: SVC mode/open-loop vector control 1: VC mode/closed-loop vector control 2: V/F control	0000	1	×
F0.0.10	Reserved parameter				
F0.0.11	Selection of panel key functions (H)	The unit: Panel key locking 0: No locking 1: All keys are locked except for UP/DW (Shuttle), Stop and RUN. 2: All keys are locked except for STOP and RUN 3: All keys are locked except for STOP. 4: Lock all keys Tens: STOP key function 0: Non-panel control mode void 1: Press STOP key in any control mode to stop the device slowly 2: Press STOP key in any control mode to stop the device freely Hundreds: Function of PANEL/REMOTE keys 0: Void 1: Stop effective 2: Continuously effective	0000	1	×

Function Code	Name	Setting Range and Description	Factory Default	Minimum Unit	Change Limit
		Kilobit: Reserved			
F0.0.12	Principal monitoring parameter (H)	d0.0~d0.55 / d1.0~d1.55	d0.00	1	

6.2 Running command selection

Function Code	Name	Setting Range and Description	Factory Default	Minimum Unit	Change Limit
F0.1.15	Reserved parameter				
F0.1.16	Reserve				
F0.1.17	Running direction (H)	The unit: direction switch 0: Void 1: Negate Tens: direction locking 0: Void (determined by the direction command) 1: FWD locking 2: REV locking	0000	1	
F0.1.18	Reserved				
F0.1.19	Reserved				
F0.1.20	Maximum output frequency	10.00~320.00Hz/100.0~1000.0Hz	60.00	0.01	
F0.1.21	Upper limiting frequency	[F0.1.22]~Min. (300.00Hz,[F0.1.20])	50.00	0.01	
F0.1.22	Lower limiting frequency	0.0Hz~[F0.1.21]	0.0	0.01	
F0.1.23	FWD jog frequency	0.0Hz~[F0.1.21]	10.00	0.01	
F0.1.24	REV jog frequency	0.0Hz~[F0.1.21]	10.00	0.01	

6.3 Frequency setting

Function Code	Name	Setting Range and Description	Factory Default	Minimum Unit	Change Limit
F0.2.25	Frequency setting channel	0: Panel digital setting (maintained after stop) 1: Panel digital setting (zero clearing after stop) 2: Panel digital setting (maintained after stop and saved after power-off) 3: Setting of panel shuttle potentiometer 4: Terminal UP/DW setting (maintained after stop) 5: Terminal UP/DW setting (zero clearing after stop) 6: Terminal UP/DW setting (maintained after stop and saved after power-off) 7: Terminal UP/DW two-way setting (maintained in bipolar mode after stop) 8: Terminal UP/DW two-way setting (maintained in bipolar mode after stop and saved after power-off) 9: Analog input AI1 10: Analog input AI2 11: Analog input AI3 12: Given by the analog input AI1bipolarity 13: Given by the analog input AI3 bipolarity 14: Pulse input Fin 15: Given by the pulse input bipolarity 16: MODBUS fieldbus set value 1 17: MODBUS fieldbus set value 2 18: AI1+AI2 19: AI2+AI3 20: AI2+pulse input Fin 21: AI1*AI2/rail-to-rail input (10V) 22: AI1/AI2 23: Process PID output 24: Reserved 25: Disturbance running frequency 26: Automatic multi-sage running frequency 27: Terminal selection multi-stage frequency 28: Virtual analog input SAI1 29: Virtual mode input SAI2	0	1	
F0.2.26	Reserved				
F0.2.27	Minimum value of frequency setting	0.0Hz~[F0.2.28]	0.0	0.01	

Function Code	Name	Setting Range and Description	Factory Default	Minimum Unit	Change Limit
F0.2.28	Maximum value of frequency setting	[F0.2.27]~[F0.1.20]	50.0	0.01	
F0.2.29	Panel digital set value of frequency setting panel	0.0Hz ~[F0.2.28]	0.0	0.01	
F0.2.30 ~ F0.2.32	Reserved parameters				

6.4 Control command source

Function Code	Name	Setting Range and Description	Factory Default	Minimum Unit	Change Limit
F0.3.33	Control command	0: Operating panel 1: External control terminal 2: MODBUS fieldbus/standard expansion card configuration	0	1	
F0.3.34	Reserved parameter				
F0.3.35	External control terminal action mode (H)	<p>The unit: Control command action mode 0: Two-line mode 1 1: Two-line mode 2 2: Three-line mode 1 3: Three-line mode 2</p> <p>Tens: control command power-on first starting mode 0: Running signal level starting 1: Running signal rising edge starting (two-line mode 1 and 2)</p> <p>Hundreds: reserved Kilobit: reserved</p>	0000	1	
F0.3.36	Reserved				

6.5 Start and stop

Function Code	Name	Setting Range and Description	Factory Default	Minimum Unit	Change Limit
F0.4.37	Start/Running permission (H)	<p>The unit: Start permission 0: Function closed 1: Permitted when the multifunctional terminal is effective 2: Command word from standard fieldbus (standard expansion card)</p> <p>Tens: Reserved</p>	0000	1	x

Function Code	Name	Setting Range and Description	Factory Default	Minimum Unit	Change Limit
		Hundreds: Running permission 0: Function closed 1: Permitted when the multifunctional terminal is effective 2: Command word from standard fieldbus (standard expansion card) Kilobit: The action mode when the running permission signal is void 0: Free stop 1: Deceleration stop			
F0.4.38	Start/Stop Mode (H)	The unit: start mode 0: Normal start 1: Revolution tracking start Tens: Reserved Hundreds: Stop mode 0: Deceleration stop 1: Free stop	0000	1	×
F0.4.39	Start frequency	0.0Hz~50.00Hz	0.50	0.01	
F0.4.40	Start frequency holding time	0.00~10.00Sec.	0.0	0.01	
F0.4.41	Start pre-excitation current	0.0~100.0(%)	35.0	0.1	
F0.4.42	Start pre-excitation time	0.00~10.00Sec.	0.10	0.01	
F0.4.43	Start delay	0.00~10.00Sec.	0.0	0.01	
F0.4.44	DC band-type brake control (H)	The unit: DC band-type brake function (effective when running commands) 0: Closed 1: Open Tens: Reserved	0000	1	
F0.4.45	DC band type brake/brake initial frequency/speed	0.0~[F0.1.21]	2.00	0.01	
F0.4.46	DC brake action time	0.0~10.00Sec.	0.0	0.01	
F0.4.47	DC band-type brake/brake injection current	0.0~100.0(%)	50.0	0.1	
F0.4.48	Restart after power-off	0: Forbidden 1: Effective	0	1	
F0.4.49	Restart after power-off/ Standby time for	0.10~10.00Sec.	0.5	0.1	

Function Code	Name	Setting Range and Description	Factory Default	Minimum Unit	Change Limit
	restart after free stop				
F0.4.50	FWD and REV transition dead time	0.00~5.00Sec.	0.0	0.01	
F0.4.51	FWD and REV switch mode	0: Switch at zero point 1: Start frequency switch	0	1	
F0.4.52	Zero speed (frequency) detection level	0.0~100.00Hz	0.1	0.01	
F0.4.53	Zero speed delay time	0.0~10.00Sec.	0.05	0.01	
F0.4.54	Emergency stop mode (EMS)	0: The inverter will stop in deceleration mode according to the emergency stop and deceleration time. 1: The inverter will immediately stop in free sliding mode.	0	1	

6.6 Acceleration and deceleration characteristics parameters

Function Code	Name	Setting Range and Description	Factory Default	Minimum Unit	Change Limit
F1.0.00	Acceleration and deceleration characteristics parameters	The unit: Acceleration and deceleration mode 0: Linear acceleration and deceleration 1: S curve acceleration and deceleration Tens: Unit of acceleration and deceleration time 0: Sec. (Second) 1: Min. (Minute)	0000	1	×
F1.0.01	Time ratio of S curve acceleration starting/deceleration ending period	5.0~100.0-[F1.0.02]	15.0	0.1	
F1.0.02	Time ratio of S curve acceleration rising/deceleration decreasing period	20.0~100.0-[F1.0.01]	70.0	0.1	
F1.0.03	Acceleration time 1	0.01~ 600.00 (Sec./Min.)	☆	0.01	
F1.0.04	Deceleration time 1	0.01~ 600.00 (Sec./Min.)	☆	0.01	
F1.0.05	Acceleration time 2	0.01~ 600.00 (Sec./Min.)	☆	0.01	
F1.0.06	Deceleration time 2	0.01~ 600.00 (Sec./Min.)	☆	0.01	
F1.0.07	Acceleration time 3	0.01~ 600.00 (Sec./Min.)	☆	0.01	
F1.0.08	Deceleration time 3	0.01~ 600.00 (Sec./Min.)	☆	0.01	
F1.0.09	Acceleration 4/jog acceleration time	0.01~ 600.00 (Sec./Min.)	☆	0.01	

Function Code	Name	Setting Range and Description	Factory Default	Minimum Unit	Change Limit
F1.0.10	Deceleration 4/jog deceleration time	0.01~ 600.00 (Sec./Min.)	☆	0.01	
F1.0.11	EMS emergency stop and deceleration time	0.01~ 600.00 (Sec./Min.)	☆	0.01	
F1.0.12	Reserve				

6.7 Carrier frequency

Function Code	Name	Setting Range and Description	Factory Default	Minimum Unit	Change Limit
F1.1.13	Carrier frequency	Three-phase voltage vector composition mode (FF.4.43 = ##0#) : 1.5~10.0KHz Two-phase voltage vector composition mode (FF.4.43 = ##1#) : 1.5~12.5KHz	☆	0.1	
F1.1.14	Carrier characteristics	The unit: Load linkage adjustment 0: Void 1: Effective Tens: Temperature linkage adjustment 0: Void 1: Effective Hundreds: Reference frequency linkage adjustment 0: Void 1: Effective Kilobit: Modulation mode 0: Asynchronous modulation 1: Synchronous modulation 2: Sound smooth	2011	1	

6.8 V/F parameters and overload protection

Function Code	Name	Setting Range and Description	Factory Default	Minimum Unit	Change Limit
F1.2.15	Motor reference frequency	5.00~300.00Hz/50.0~1000.0Hz	50.00	0.01	×
F1.2.16	Motor reference voltage	50~500V / 25 ~ 250V	380/220	1	
F1.2.17	Reserved	-	-	-	×
F1.2.18	Torque increasing voltage for motor	0.0~20.0%	☆	0.1	
F1.2.19	Frequency point 1 of motor V/F curve	0.0~[F0.1.21]	0.0	0.01	×
F1.2.20	Voltage point 1 of Motor V/F curve	0~500V	0.0	0.1	
F1.2.21	Frequency point 2 of motor 1 V/F curve	0.0~[F0.1.21]	0.0	0.01	×

Function Code	Name	Setting Range and Description	Factory Default	Minimum Unit	Change Limit
F1.2.22	Voltage point 2 of Motor V/F curve	0~500V	0.0	0.1	
F1.2.23	Frequency point 3 of motor V/F curve	0.0~[F0.1.21]	0.0	0.01	×
F1.2.24	Voltage point 3 of Motor V/F curve	0~500V	0.0	0.1	
F1.2.25	Motor slip frequency compensation	0~150(%)	0	1	
F1.2.26 ~ F1.3.38	Reserve	-	-	-	×

6.9 Steady running

Function Code	Name	Setting Range and Description	Factory Default	Minimum Unit	Change Limit
F1.4.39	Acceleration/deceleration current limiting level	120~180(%)	150	1	
F1.4.40	Strong start current limiting level	120~200(%)	150	1	
F1.4.41	Strong start current holding time	0.00~5.00Sec.	0.0	0.01	
F1.4.42	Trip Suppression Selection	<p>The unit: Overvoltage suppression adjustor 0: Closed 1: Effective (Frequency increasing suppression)</p> <p>2: Terminal Inputs</p> <p>Tens: Undervoltage suppression adjustor 0: Closed 1: Effective (frequency decreasing suppression)</p> <p>Hundreds: Frequency decreasing and current limiting adjustor 0: Closed 1: Effective</p> <p>Kilobit: Failure Auto Recovery Mode 0: Speed tracking start 1: Normal Start</p>	0111	1	
F1.4.43	Action level of the overvoltage adjustor	660~800 V	740	1	
F1.4.44	Overvoltage adjusting gain	0.10~10.00	1.00	0.01	
F1.4.45	Action level of the undervoltage adjustor	[FF.2.35]~480V	400V	1	

Function Code	Name	Setting Range and Description	Factory Default	Minimum Unit	Change Limit
F1.4.46	Undervoltage adjusting gain	0.10~10.00	1.00	0.01	
F1.4.47	Action level of the frequency decreasing and current limiting adjustor	20~200(%)	180	1	
F1.4.48	Adjusting gain of the frequency decreasing and current limiting adjustor	0.10~10.00	1.00	0.01	
F1.4.49	Recovery times of fault self resetting	0~5(the self-recovery function is deactivated when it is set to 0)	0	1	
F1.4.50	The recovery waiting time of fault self resetting	0.2~100.0Sec. (Real waiting time progressive increase with recovery times)	1.0	0.1	
F1.4.51	Time period for self resetting timing	900~36000Sec.	3600	1	
F1.4.52	Selection of self resetting fault	<p>The unit: overcurrent 0: Self resetting forbidden 1: Self resetting permitted</p> <p>The tens: overvoltage 0: Self resetting forbidden 1: Self resetting permitted</p> <p>The hundreds: Output grounding 0: Self resetting forbidden 1: Self resetting permitted</p> <p>Kilobit: Running undervoltage 0: Self resetting forbidden 1: Self resetting permitted</p>	0000	1	F1.4.52
F1.4.53	Display coefficient	0.001 ~ 60.000	1.000	0.001	F1.4.53

6.10 Motor parameters

Function Code	Name	Setting Range and Description	Factory Default	Minimum Unit	Change Limit
F2.0.00	Rated power (tested from start static status after modification)	0.1~1000.0KW	☆	0.1KW	×
F2.0.01	Rated voltage (tested from start static status after modification)	30~480V	380/220	1V	×
F2.0.02	Rated current (tested from start static status after modification)	0.01~650.00A	☆	0.01A	×
F2.0.03	Rated frequency (tested from start static status after modification)	Max{5.00,[F2.0.04]/60} ~300.00Hz	50.00	0.01Hz	×
F2.0.04	Rated revolution (tested from start static status after modification)	10~Min.{30000,60*[F2.0.03]}rpm	☆	1rpm	×
F2.0.05	Idling current	0.15*[F2.0.02]~ 0.8*[F2.0.02]	☆	0.01A	×
F2.0.06	Stator resistance	0.01~6500mΩ	0.01	Hint	×
F2.0.07	Stator inductance	0.001~6500.0mH	0.01	Hint	×
F2.0.08	Total leakage inductance	0.001~6500.0mH	0.01	Hint	×
F2.0.09	Rotator time constant	5.0~6500.0ms	☆	0.1ms	×
F2.0.10	Slip compensation coefficient	0.50~1.50	1.00	0.01	
F2.0.11 ~ F2.0.23	Retention parameter				×
F2.0.24	Z pulse initial angle	0.0 ~359.9	0.0	0.1	×
F2.0.25	Motor overload protection coefficient (131 closed)	50.0~131.0(%) (131--closed)	110.0	0.1	
F2.1.26 ~ F2.1.51	Reserved				×

6.11 Parameter measurement and pre-excitation

Function Code	Name	Setting Range and Description	Factory Default	Minimum Unit	Change Limit
F2.2.52	Start excitation time in vector mode	0.02 ~ 2.50Sec.	☆	0.01	
F2.2.53	Motor parameter measurement	0: Closed 1: Static identification 2: Static + operating parameter identification	0	1	×



The minimum unit of stator resistance, stator inductance and total leakage inductance of asynchronous machines is relevant with models.

6.12 Multifunctional input terminal

Function Code	Name	Setting Range and Description	Factory Default	Minimum Unit	Change Limit
F3.0.00	Multifunctional input terminal DI1	0~96	0	1	×
F3.0.01	Multifunctional input terminal DI2	0~96	0	1	×
F3.0.02	Multifunctional input terminal DI3	0~96	7	1	×
F3.0.03	Multifunctional input terminal DI4	0~96	8	1	×
F3.0.04	Multifunctional input terminal DI5	0~96	13	1	×
F3.0.05	Multifunctional input terminal DI6	0~96	0	1	×
F3.0.06	Multifunctional input terminal DI7/ expansion function	0~96	0	1	×
F3.0.07	Multifunctional input terminal DI8/ expansion function	0~96	0	1	×
F3.0.08	Multifunctional input terminal DI9/Fin/ standard expansion card	0~98	97	1	×
F3.0.09	Multifunctional terminal filtering time (DI1~DI5)	1~50ms	5ms	1	
F3.0.10	Multifunctional terminal filtering time (DI6~DI9)/ standard expansion card	1~50ms	5ms	1	
F3.0.11	Input terminal effective level (H)	<p>The unit: DI1~DI4 terminal 0~F: 4-bit binary, bit=0 power-on effective, 1 disconnection effective</p> <p>Tens: DI5~DI8 terminal The same as above</p> <p>Hundreds: DI9 terminal The same as above</p> <p>Kilobit: Reserved</p>	0000	1	×

6.13 Multifunctional output terminal multifunctional output terminal

Function Code	Name	Setting Range and Description	Factory Default	Minimum Unit	Change Limit
F3.1.12	Multifunctional output terminal DO1	0~62	1	1	
F3.1.13	Multifunctional output terminal DO2	0~62	2	1	
F3.1.14	Multifunctional output terminal DO3/Fout/ expansion function	0~63	63	1	
F3.1.15	DO1 terminal effective signal output delay time	0.0~10.00Sec.	0.0	0.01	
F3.1.16	DO1 terminal void signal output delay time	0.0~10.00Sec.	0.0	0.01	
F3.1.17	DO2 terminal effective signal output delay time	0.0~10.00Sec.	0.0	0.01	
F3.1.18	DO2 terminal void signal output delay time	0.0~10.00Sec.	0.0	0.01	
F3.1.19	DO3 terminal effective signal output delay time	0.0~10.00Sec.	0.0	0.01	
F3.1.20	DO3 terminal void signal output delay time	0.0~10.00Sec.	0.0	0.01	
F3.1.21	Multifunctional relay output (RO1A/B/C)	0~62	4	1	
F3.1.22	Multifunctional relay output (RO2A/B/C)/standard expansion card	0~62	5	1	
F3.1.23	RO1 power-on delay time	0.0~10.00Sec.	0.0	0.01	
F3.1.24	RO1 disconnection delay time	0.0~10.00Sec.	0.0	0.01	
F3.1.25	RO2 power-on delay time	0.0~10.00Sec.	0.0	0.01	
F3.1.26	RO2 disconnection delay time	0.0~10.00Sec.	0.0	0.01	
F3.1.27	Input variable of monitor 1	0~44 (referring to the monitor variable comparison table)	0	1	
F3.1.28	Input variables of monitor 2		1	1	
F3.1.29	Input variables of monitor 3		2	1	
F3.1.30	Lower limiting value of monitor 1 variables (relative to full scale value)	0.0~100.0 (%)	0.0	0.1	
F3.1.31	Upper limiting value of monitor 1 variables (relative to full scale value)	0.0~100.0 (%)	100.0	0.1	
F3.1.32	Lower limiting value of monitor 2 variables (relative to full scale value)	0.0~100.0 (%)	0.0	0.1	
F3.1.33	Upper limiting value of monitor 2 variables (relative to full scale value)	0.0~100.0 (%)	100.0	0.1	
F3.1.34	Lower limiting value of monitor 3 variables (relative to full scale value)	0.0~100.0 (%)	0.0	0.1	
F3.1.35	Upper limiting value of monitor 3 variables (relative to full scale value)	0.0~100.0 (%)	100.0	0.1	

6.14 Pulse input (Configured with standard expansion I/O board, and this group of parameters are effective when D19 selects the frequency input function)

Function Code	Name	Setting Range and Description	Factory Default	Minimum Unit	Change Limit
F3.2.36	Minimum pulse input frequency D19/Fin	0.0~100.00KHz	0.0	0.01	
F3.2.37	Maximum pulse input frequency D19/Fin	0.01~100.00KHz	10.0	0.01	
F3.2.38	Pulse detection cycle	1ms~20ms	10	1	
F3.2.39	Number of single-loop pulse	1~4096	1024	1	
F3.2.40	Mechanical transmission ratio (=pulse shaft revolution: motor shaft revolution)	0.010 ~ 10.000	1.000	0.001	
F3.2.41	Driving wheel diameter (for liner speed calculation)	0.1~2000.0mm	100.0	0.1	
F3.2.42	Maximum accumulative length value	10m~50000m	50000	1m	
F3.2.43	Maximum liner speed	0.01~500.00m/sec.	10.00	0.01	
F3.2.44	Current accumulative length value	0~50000m	—	1	R
F3.2.45	Current liner speed	0.0~500.00m/sec.	—	0.01	R

6.15 Pulse output (Equipped with standard expansion I/O board, and this group of parameters are effective when DO3 terminal selects the frequency output function)

Function Code	Name	Setting Range and Description	Factory Default	Minimum Unit	Change Limit
F3.3.46	Type of output pulse signal DO3/Fout	0: 0.25~100.00KHz frequency signal 1: 10.0~1000.0Hz frequency signal 2: Pulse width modulation (PWM) signal	0	1	
F3.3.47	Minimum output frequency DO3/Fout	0.25~100.00KHz	0.25	0.01	
F3.3.48	Maximum output frequency DO3/Fout	0.25~100.00KHz (PWM signal reference frequency)	10.0	0.01	
F3.3.49	Pulse output mapping variable	0~45 (monitor variable comparison table)	0	1	
F3.3.50	DO3/Fout assignment lower limit	0.0~[F3.3.51]	0.0	0.1	
F3.3.51	DO3/Fout assignment upper limit	[F3.3.50]~100.0 (%)	100.0	0.1	

6.16 Analog input

Function Code	Name	Setting Range and Description	Factory Default	Minimum Unit	Change Limit
F4.0.00	Analog input AI1 min. (0~10V)	0.00~[F4.0.01]	0.0	0.01	
F4.0.01	Analog input AI1 max. (0~10V)	[F4.0.00]~10.00V	10.00	0.01	
F4.0.02	Analog input AI2 min. (4~20mA)	0.00~[F4.0.03]	4.00	0.01	
F4.0.03	Analog input AI2 max. (4~20mA)	[F4.0.02]~20.00mA	20.00	0.01	
F4.0.04	Analog input AI3 min. (-10V~10V)/standard expansion card	-10.00~[F4.0.05]	0.00	0.01	
F4.0.05	Analog input AI3 max. (-10V~10V)/standard expansion card	[F4.0.04]~10.00V	10.00	0.01	
F4.0.06	Analog input AI1 filtering time coefficient	1~1000ms	10	1	
F4.0.07	Analog input AI2 filtering time coefficient	1~1000ms	10	1	
F4.0.08	Analog input AI3 filtering time coefficient/standard expansion card	1~1000ms	10	1	

6.17 Analog input curve correction

Function Code	Name	Setting Range and Description	Factory Default	Minimum Unit	Change Limit
F4.1.09	Analog input AI1 curve correction point 1	[F4.0.00]~[F4.0.01]	0.0	0.01	
F4.1.10	Analog input AI1 curve correction value 1	[F4.0.00]~[F4.0.01]	0.0	0.01	
F4.1.11	Analog input AI1 curve correction point 2	[F4.0.00]~[F4.0.01]	10.00	0.01	
F4.1.12	Analog input AI1 curve correction value 2	[F4.0.00]~[F4.0.01]	10.00	0.01	
F4.1.13	Analog input AI2 curve correction point 1	[F4.0.02]~[F4.0.03]	4.00	0.01	
F4.1.14	Analog input AI2 curve correction value 1	[F4.0.02]~[F4.0.03]	4.00	0.01	
F4.1.15	Analog input AI2 curve correction point 2	[F4.0.02]~[F4.0.03]	20.00	0.01	
F4.1.16	Analog input AI2 curve correction value 2	[F4.0.02]~[F4.0.03]	20.00	0.01	
F4.1.17	Analog input AI3 zero hysteresis/standard expansion card	0.0~2.00	0.10	0.01	
F4.1.18	Analog input AI3 curve correction point 1/standard expansion card	[F4.0.04]~[F4.0.05]	0.0	0.01	
F4.1.19	Analog input AI3 curve correction value 1/standard expansion card	[F4.0.04]~[F4.0.05]	0.0	0.01	
F4.1.20	Analog input AI3 curve correction point 2/standard expansion card	[F4.0.04]~[F4.0.05]	10.00	0.01	
F4.1.21	Analog input AI3 curve correction value 2/standard expansion card	[F4.0.04]~[F4.0.05]	10.00	0.01	

6.18 Analog output

Function Code	Name	Setting Range and Description	Factory Default	Minimum Unit	Change Limit
F4.2.22	Mapping variable of multifunctional analog output AO1 (subjecting to F5.4.44 exceeding function)	0~45 (monitor variable comparison table)	0	1	
F4.2.23	Mapping variable of multifunctional analog output AO2/standard expansion card	0~45 (monitor variable comparison table)	2	1	
F4.2.24	AO1 minimum	0.00~10.00V	0.0	0.01	
F4.2.25	AO1 maximum	0.00~10.00V	10.00	0.01	
F4.2.26	AO1 lower limiting value	0.0~[F4.2.27]	0.0	0.1	
F4.2.27	AO1 upper limiting value	[F4.2.26]~100.0 (%)	100.0	0.1	
F4.2.28	AO1 filtering time coefficient	0.01~10.00Sec.	0.10	0.01	
F4.2.29	AO1 fixed output value (at the time of fixed output value)	0.0~20.00mA (0.0~10.00V)	0.0	0.01	
F4.2.30	AO2 minimum value /standard expansion card	0.00~10.00V	0.0	0.01	
F4.2.31	AO2 maximum value/ standard expansion card	0.00~10.00V	10.00	0.01	
F4.2.32	AO2 lower limiting value / standard expansion card	0.0~[F4.2.33]	0.0	0.1	
F4.2.33	AO2 upper limiting value / standard expansion card	[F4.2.32]~100.0 (%)	100.0	0.1	
F4.2.34	AO2 filtering time coefficient/ standard expansion card	0.01~10.00Sec.	0.10	0.01	
F4.2.35	AO2 fixed output value (at the time of fixed output value)/ standard expansion card	0.0~20.00mA (0.0~10.00V)	0.0	0.01	

6.19 Analog input wire breakage detection

Function Code	Name	Setting Range and Description	Factory Default	Minimum Unit	Change Limit
F4.3.36	Analog input wire breakage detection function	The unit: AI1 wire breakage detection 0: Void 1: Effective Tens: AI2 wire breakage detection 0: Void 1: Effective Hundreds: AI3 wire breakage detection 0: Void 1: Effective	0000	1	×
F4.3.37	AI1 wire breakage detection threshold value (the value before correction)	0.00~10.00V	0.25	0.01	
F4.3.38	AI1 wire breakage detection delay action time	0.01~50.00Sec.	2.00	0.01	
F4.3.39	Action selection after AI1 wire-break	0: No action (for non-stop alarm) 1: Forcely set to the minimum 2: Forcely set to the maximum 3: Forcely set to the defaults value (F4.3.40) 4: Inverter forced trip stop	0	1	×
F4.3.40	Default input value after AI1 wire-break	0.00~10.00V	0.0	0.01	
F4.3.41	AI2 wire breakage detection threshold value (the value before correction)	0.00~20.00mA	4.00	0.01	
F4.3.42	AI2 wire breakage detection delay action time	0.01~50.00Sec.	2.00	0.01	
F4.3.43	Action selection after AI2 wire-break	0: No action (for non-stop alarm) 1: Forcely set to the minimum 2: Forcely set to the maximum 3: Forcely set to the defaults value (F4.3.44) 4: Inverter forced trip stop	0	1	×
F4.3.44	Default input value after AI2 wire breakage	0.00~20.00mA	4.00	0.01	
F4.3.45	AI3 wire breakage detection upper threshold value (the value before correction)	-10.00~10.00V	0.25	0.01	
F4.3.46	AI3 wire breakage detection lower threshold value (the value before correction)	-10.00~10.00V	-0.25	0.01	

Function Code	Name	Setting Range and Description	Factory Default	Minimum Unit	Change Limit
F4.3.47	AI3 wire breakage detection delay action time	0.01~50.00Sec.	2.00	0.01	
F4.3.48	Action selection after AI3 wire-break	0: No action (for non-stop alarm) 1: Forcedly set to the minimum 2: Forcedly set to the maximum 3: Forcedly set to the defaults value (F4.3.49) 4: Inverter forced trip stop	0	1	×
F4.3.49	Default input value after AI3 wire breakage	-10.00~10.00V	0.0	0.01	

6.20 Virtual analog input

Function Code	Name	Setting Range and Description	Factory Default	Minimum Unit	Change Limit
F4.4.50	Virtual analog input SAI1	0: void (0 value) 1: SAI_CF1*AI1 2: SAI_CF1*AI2 3: SAI_CF1*AI3 4: SAI_CF1*AO1	0	1	×
F4.4.51	Virtual analog input SAI2	5: SAI_CF1*AO2 6: SAI_CF1*AI1+SAI_CF2*AI2+SAI_CST 7: SAI_CF1*AI1+SAI_CF2*AI3+SAI_CST 8: SAI_CF1*AO1+SAI_CF2*AO2+SAI_CST 9: SAI_CF1*AI1+SAI_CF2*AO1+SAI_CST 10: SAI_CF1*AI2+SAI_CF2*AO2+SAI_CST 11: SAI_CF1*AI1+SAI_CF2*AO1 12: SAI_CF1*AI3+SAI_CF2*AO2 13: SAI1_CF1*AI1/AI2+SAI_CST 14: SAI2_CF2*AI2/AI3+SAI_CST 15: SAI1_CF1*AI1/AI3+SAI_CST	0	1	×
F4.4.52	Virtual input combination coefficient 1 (SAI_CF1)	0.01 ~ 500.00	1.00	0.01	×
F4.4.53	Virtual input combination coefficient 2(SAI_CF2)	0.01 ~ 500.00	1.00	0.01	×
F4.4.54	Virtual input combination constant (SAI_CST)	-4080 ~ 4080	0	1	×

6.21 Hopping frequency

Function Code	Name	Setting Range and Description	Factory Default	Minimum Unit	Change Limit
F5.0.00	Hopping frequency1	0.0~[F0.1.21]	0.0	0.01	×
F5.0.01	Range of hopping frequency 1	0.0~10.00Hz	0.0	0.01	×
F5.0.02	Hopping frequency 2	0.0~[F0.1.21]	0.0	0.01	×
F5.0.03	Range of hopping frequency 2	0.0~10.00Hz	0.0	0.01	×
F5.0.04	Hopping frequency3	0.0~[F0.1.21]	0.0	0.01	×
F5.0.05	Range of hopping frequency 3	0.0~10.00Hz	0.0	0.01	×

6.22 Built-in auxiliary timer

Function Code	Name	Setting Range and Description	Factory Default	Minimum Unit	Change Limit
F5.1.06	Timer 1 (UT1) operating mode (H)	The unit: Clock selection 0: 1ms 1: 1Sec. 2: 1min. 3: Timer 1 cycle reaching pulse (effective for UT2, UT3) 4: Timer 2 cycle reach pulse (only effective for UT3) Tens: Start and stop 0: Multifunctional terminal triggering start(Edge triggering function No. 52~54) 1: Stop-->Run status change triggering (edge triggering) 2: Run-->Stop status change triggering (edge triggering) 3: Synchronously started with timer 1 (effective for UT2, UT3) 4: Timer 1 cycle reach pulse (effective for UT2, UT3) 5: Timer 2 cycle reach pulse (effective for UT3) Hundreds: Timer status resetting (timer value and status) 0: Multifunctional terminal (Function No. 55~57) 1: Automatic resetting when the cycle is reached 2: Automatic resetting when timer is stopped Kilobit: timing cycle 0: Single-cycle timing (resetting and re-triggering required) 1: Multi-cycle timing (start again after auto clearing)	0000	1	×
F5.1.07	Timer 2 (UT2) operating mode (H)				
F5.1.08	Timer 3 (UT3) operating mode (H)				
F5.1.09	Timer 1 timing cycle	0~65535 (clock cycle)	30000	1	
F5.1.10	Timer 1 comparative	0~[F5.1.09]	10000	1	

Function Code	Name	Setting Range and Description	Factory Default	Minimum Unit	Change Limit
	threshold value				
F5.1.11	Timer 2 timing cycle	0~65535 (clock cycle)	30000	1	
F5.1.12	Timer 2 comparative threshold value	0~[F5.1.11]	10000	1	
F5.1.13	Timer 3 timing cycle	0~65535 (clock cycle)	30000	1	
F5.1.14	Timer 3 comparative threshold value	0~[F5.1.13]	10000	1	
F5.1.15	Timer door control signal selection (H)	<p>The unit: timer 1 (UT1) gated signal 0: No gating function 1: Multifunctional terminal (Function No. 58) 2: timer 1 comparative value reached (effective for UT2, UT3) 3: Timer 1 cycle reached (effective for UT2, UT3) 4: Timer 2 comparative value reached (effective for UT3) 5: Timer 2 cycle reached (effective for UT3)</p> <p>Tens: Timer 2 (UT2) gated signal selection The same as above</p> <p>Hundreds: Timer 3 (UT3) gated signal selection The same as above</p>	0000	1	
F5.1.16	Timer 1 output signal (H)	<p>The unit: output signal1 0: Comparative value reached (0.5s pulse) 1: Comparative value reached (level) 2: Comparative value reached and reversed 3: Cycle reached (0.5s pulse) 4: Cycle reached (level) 5: Cycle reached and reversed 6: Comparative value or cycle reached and reversed</p> <p>Tens: Output signal 2 The same as above</p> <p>Hundreds: Reserved</p>	0041	1	
F5.1.17	Timer 2 output signal (H)		0041	1	
F5.1.18	Timer 3 output signal (H)		0041	1	
F5.1.19	Timer value display unit (H)	<p>The unit: timer 1 0: Clock unit (original value) 1: Sec. 2: Min. 3: H.</p> <p>Tens: timer 2</p>	0000	1	

Function Code	Name	Setting Range and Description	Factory Default	Minimum Unit	Change Limit
		The same as above Hundreds: timer 3 The same as above			

6.23 Built-in auxiliary counter

Function Code	Name	Setting Range and Description	Factory Default	Minimum Unit	Change Limit
F5.2.20	Counter 1 operating mode (H)	The unit: Counter pulse selection (Function No. 44, 45) 0: Multifunctional terminal "void→effective" 1: Multifunctional terminal "effective→void" 2: Aforesaid two conditions are both effective	0000	1	
F5.2.21	Counter 2 operating mode (H)	Tens: Starting mode 0: Start immediately after power-on (no trigger start) 1: Multifunctional terminal trigger (Function No. 46, 47) 2: Stop→Run status change triggering (edge triggering) 3: Run→Stop Status change triggering (edge triggering) 4: Running status (gated triggering) 5: Stop status (gated triggering) Hundreds: Counter resetting source 0: Multifunctional terminal (Function No.48, 49) 1: Set value 1 reaches auto resetting 2: Set value 2 reaches auto resetting Kilobit: Counter save data when power off 0: Counter not save data when power off 1: Counter save data when power off	0000	1	
F5.2.22	Set value 1 of counter 1	0~65535	1000	1	
F5.2.23	Set value 2 of counter 1	0~65535	2000	1	
F5.2.24	Set value 1 of counter 2	0~65535	1000	1	
F5.2.25	Set value 2 of counter 2	0~65535	2000	1	
F5.2.26	Counter 1 output signal (H)	The unit: output signal1	0000	1	

Function Code	Name	Setting Range and Description	Factory Default	Minimum Unit	Change Limit
F5.2.27	Counter 2 output signal (H)	0: Reach set value 1 (0.5Sec.pulse) 1: Reach set value 1 (level) 2: Set value 1 reached and reversed 3: Reach set value 2 (0.5Sec.pulse) 4: Reach set value 2 (level) 5: Set value 1reached and reversed 6: Set value 1 or set value 2 reached and reversed Tens: output signal 2 The same as above Hundreds: Reserved Kilobit: Reserved	0000	1	

6.24 Auxiliary functions

Function Code	Name	Setting Range and Description	Factory Default	Minimum Unit	Change Limit
F5.3.28	Priority selection of frequency (revolution) command source (H)	The unit: 1st priority (highest) 0: No definition 1: Process PID output 2: Reserved 3: Swing frequency running command 4: Automatic multi-stage frequency running command 5: Multi-stage operating frequency selected by external terminals 6: Revolution setting channel (F8.0.00) 7: Frequency setting channel (F0.2.25) Tens: 2nd priority The same as above Hundreds: 3rd priority The same as above Kilobit: 4th priority The same as above	0000	1	×
F5.3.29	Lower limiting frequency action mode	0: Output 0 frequency when it is below the lower limiting frequency 1: Output the lower limiting frequency when it is below the lower limiting frequency	0	1	
F5.3.30	Automatic voltage	0: Closed	0	1	

Function Code	Name	Setting Range and Description	Factory Default	Minimum Unit	Change Limit
	regulation (effective in VVV control mode)	1: Effective 2: Deceleration process void			
F5.3.31	Automatic energy-saving operation (effective for asynchronous motors)	0: Void 1: Effective	0	1	
F5.3.32	Magnetic flux brake	0: Void 1: Effective 2: Multifunctional terminal effective (Function No. 65)	0	1	
F5.3.33	Magnetic flux braking strength (brake exciting current)	30~120%	☆	1	
F5.3.34	Voltage overmodulation	0: Void 1: Effective	1	1	
F5.3.35	Use ratio of dynamic braking (for some models)	50~100(%)	100	1	
F5.3.36	Level of dynamic braking starting action	650~760V	690	1	
F5.3.37	Vibration suppression coefficient (only effective in VF control mode)	0.0, 0.01~10.00	0.0	0.01	
F5.3.38	Load dynamic balance	1: Effective 2: Multifunctional terminal effective (Function No. 38)	0	1	
F5.3.39	Reference source for dynamic balance load	0: Digital setting (F5.3.40) 1: AI1 input 2: AI2 input 3: AI3 input 4: Fieldbus set value 1	0	1	
F5.3.40	Reference value for dynamic balance load	0.0~ 200.0 (%)	100.0	0.1	
F5.3.41	Dynamic balance adjustment gain	0.0~100.00	50.00	0.01	
F5.3.42	Dynamic balance adjustment limit	0.0~100.00 (%)	1.00	0.01	
F5.4.43 ~ F5.4.47	Reserved				

6.25 Multi-stage frequency setting

Function Code	Name	Setting Range and Description	Factory Default	Minimum Unit	Change Limit
F6.0.00	1 st operating frequency	[F0.1.22]~[F0.1.21]	5.00	0.01	
F6.0.01	2 nd operating frequency	[F0.1.22]~[F0.1.21]	10.00	0.01	
F6.0.02	3 rd operating frequency	[F0.1.22]~[F0.1.21]	15.00	0.01	
F6.0.03	4 th operating frequency	[F0.1.22]~[F0.1.21]	20.00	0.01	
F6.0.04	5 th operating frequency	[F0.1.22]~[F0.1.21]	25.00	0.01	
F6.0.05	6 th operating frequency	[F0.1.22]~[F0.1.21]	30.00	0.01	
F6.0.06	7 th operating frequency	[F0.1.22]~[F0.1.21]	35.00	0.01	
F6.0.07	8 th operating frequency	[F0.1.22]~[F0.1.21]	40.00	0.01	
F6.0.08	9 th operating frequency	[F0.1.22]~[F0.1.21]	45.00	0.01	
F6.0.09	10 th operating frequency	[F0.1.22]~[F0.1.21]	50.00	0.01	
F6.0.10	11 th operating frequency	[F0.1.22]~[F0.1.21]	25.00	0.01	
F6.0.11	12 th operating frequency	[F0.1.22]~[F0.1.21]	5.00	0.01	
F6.0.12	13 th operating frequency	[F0.1.22]~[F0.1.21]	15.00	0.01	
F6.0.13	14 th operating frequency	[F0.1.22]~[F0.1.21]	35.00	0.01	
F6.0.14	15 th operating frequency	[F0.1.22]~[F0.1.21]	50.00	0.01	

6.26 Simple programmable multi-stage operation

Function Code	Name	Setting Range and Description	Factory Default	Minimum Unit	Change Limit
F6.1.15	Selection of programmable multi-stage speed operation mode (H)	<p>The unit: Function selection 0: Function closed 1: Multi-stage frequency/revolution operation effective 2: Multi-stage frequency/revolution operation condition effective (Function No. 23) 3: Multi-stage PID setting operation effective 4: Multi-stage PID setting operation condition effective (Function No. 23)</p> <p>Tens: Operation mode 0: Single cycle 1: Single cycle stop mode 2: Continuous cycle 3: Continuous cycle stop mode 4: Keeping the final value 5: Keeping the final value stop mode</p> <p>Hundreds: Selection of breakpoint/stop recovery mode 0: Restore running at the first stage 1: Start running at the interruption time (effective for multi-stage frequency/revolution operation) 2: Start running at the stage of interruption</p> <p>Kilobit: Power-off status storage 0: Not stored 1: Stored</p>	0000	1	×

Function Code	Name	Setting Range and Description	Factory Default	Minimum Unit	Change Limit
F6.1.16	Stage 1 setting (H)	The unit: Operating frequency source/setting source at each stage 0: multi-stage frequency setting 1~15/Process PID multi-stage setting 1~7 1: Frequency command (F0.1.16)/Process PID setting (F7.0.01) Tens: Setting direction of each stage 0: FWD 1: REV 2: Determined by the running command channel Hundreds: Selection of acceleration and deceleration time at each stage 0: Acceleration and deceleration time 1 1: Acceleration and deceleration time 2 2: Acceleration and deceleration time 3 3: Acceleration and deceleration time 4 Kilobit: Running time unit of each stage 0: Sec. 1: Min.	0000	1	
F6.1.17	Stage 2 setting (H)		0000	1	
F6.1.18	Stage 3 setting (H)		0000	1	
F6.1.19	Stage 4 setting (H)		0000	1	
F6.1.20	Stage 5 setting (H)		0000	1	
F6.1.21	Stage 6 setting (H)		0000	1	
F6.1.22	Stage 7 setting (H)		0000	1	
F6.1.23	Stage 8 setting (H)		0000	1	
F6.1.24	Stage 9 setting (H)		0000	1	
F6.1.25	Stage 10 setting (H)		0000	1	
F6.1.26	Stage 11 setting (H)		0000	1	
F6.1.27	Stage 12 setting (H)		0000	1	
F6.1.28	Stage 13 setting (H)		0000	1	
F6.1.29	Stage 14 setting (H)		0000	1	
F6.1.30	Stage 15 setting (H)		0000	1	
F6.1.31	Stage 1 running time	0.0~6500.0(Sec./Min.)	0.0	0.1	
F6.1.32	Stage 2 running time	0.0~6500.0(Sec./Min.)	0.0	0.1	
F6.1.33	Stage 3 running time	0.0~6500.0(Sec./Min.)	0.0	0.1	
F6.1.34	Stage 4 running time	0.0~6500.0(Sec./Min.)	0.0	0.1	
F6.1.35	Stage 5 running time	0.0~6500.0(Sec./Min.)	0.0	0.1	
F6.1.36	Stage 6 running time	0.0~6500.0(Sec./Min.)	0.0	0.1	
F6.1.37	Stage 7 running time	0.0~6500.0(Sec./Min.)	0.0	0.1	
F6.1.38	Stage 8 running time	0.0~6500.0(Sec./Min.)	0.0	0.1	
F6.1.39	Stage 9 running time	0.0~6500.0(Sec./Min.)	0.0	0.1	
F6.1.40	Stage 10 running time	0.0~6500.0(Sec./Min.)	0.0	0.1	
F6.1.41	Stage 11 running time	0.0~6500.0(Sec./Min.)	0.0	0.1	
F6.1.42	Stage 12 running time	0.0~6500.0(Sec./Min.)	0.0	0.1	
F6.1.43	Stage 13 running time	0.0~6500.0(Sec./Min.)	0.0	0.1	
F6.1.44	Stage 14 running time	0.0~6500.0(Sec./Min.)	0.0	0.1	
F6.1.45	Stage 15 running time	0.0~6500.0(Sec./Min.)	0.0	0.1	

6.27 Swing frequency operation

Function Code	Name	Setting Range and Description	Factory Default	Minimum Unit	Change Limit
F6.2.46	Function selection (H)	<p>The unit: Function Setting 0: Function closed 1: Function effective 2: Terminal selectivity effective (Function No. 24)</p> <p>Tens: Stop restart mode 0: Start with the memory status before stop 1: Restart</p> <p>Hundreds: Swing control 0: Fixed swing (relative maximum frequency) 1: Variable swing (relative central frequency)</p> <p>Kilobit: Status storage 0: Not saved after power-off, and run again after restart 1: Save the status after power-off, and run again from the saved status.</p>	0000	1	x
F6.2.47	Swing frequency preset frequency	0.0~[F0.1.21]	10.00	0.01	
F6.2.48	Preset frequency waiting time	0.0~6000.0Sec.	0.0	0.1	
F6.2.49	Swing frequency amplitude	0.0~50.0(%)	10.0	0.1	
F6.2.50	Sudden jump frequency	0.0~50.0(%)	10.0	0.1	
F6.2.51	Triangular wave rising time	0.1~1000.0Sec.	10.0	0.1	
F6.2.52	Triangular wave decreasing time	0.1~1000.0Sec.	10.0	0.1	
F6.2.53	Frequency setting in the center of the swing frequency	0.0~[F0.1.21]	10.00	0.01	

6.28 Process PID (4ms control cycle)

Function Code	Name	Setting Range and Description	Factory Default	Minimum Unit	Change Limit
F7.0.00	Process PID function selection	<p>The unit: Process PID controller selection 0: Process PID closed 1: Unconditionally effective 2: External multifunctional terminal selectivity effective (Function No. 22)</p> <p>Tens: Reserved</p> <p>Hundreds: Process PID controller output 0: frequency /revolution set value 1: Independent PID (can be set by AO terminal output or as torque)</p>	0000	1	x
F7.0.01	Process PID set value selection	0: Setting channel 1 independently effective 1: Setting channel 2 independently effective 2: Multifunctional terminal selection (Function No. 31) 3: Setting channel 1+Setting channel 2 4: Setting channel 1-Setting channel 2 5: Setting channel 1* (1+Setting channel 2/100.0) 6: Setting channel 1* (1-Setting channel 2/100.0) 7: Setting channel 1*Setting channel 2/100.0	0	1	
F7.0.02	Process PID setting channel 1	0: Internal digital setting (F7.0.08) (power-off auto save)	0	1	x
F7.0.03	Process PID setting channel 2	1: Panel shuttle potentiometer preset 2: Analog input AI1 3: Analog input AI2 4: Analog input AI3 5: UP/DW terminal single polarity adjustment (clear after stop) 6: UP/DW terminal single polarity adjustment (maintained after stop and saved after power-off) 7: Analog input AI3 dual polarity setting 8: UP/DW terminal dual polarity adjustment (clear after stop) 9: UP/DW terminal dual polarity adjustment (maintained after stop and saved after power-off) 10: MODBUS Fieldbus set value 1 11: MODBUS Fieldbus set value 2	0	1	x
F7.0.04	Analog input quantity corresponding to 0% setting (Channel 1)	0.0V~ [F7.0.05]/ AI2: 0.0mA ~[F7.0.05]	0.0	0.01	

Function Code	Name	Setting Range and Description	Factory Default	Minimum Unit	Change Limit
F7.0.05	Analog input quantity corresponding to 100% setting (Channel 1)	[F7.0.04]~10.00 /AI2: [F7.0.04]~20.00mA	10.00	0.01	
F7.0.06	Analog input quantity corresponding to 0% setting (Channel 2)	0.0V~[F7.0.07]/AI2: 0.0mA ~[F7.0.07]	0.0	0.01	
F7.0.07	Analog input quantity corresponding to 100% setting (Channel 2)	[F7.0.06]~10.00 /AI2: [F7.0.06]~20.00mA	10.00	0.01	
F7.0.08	Process PID internal digital preset	-100.0~100.0 (%)	0.0	0.1	
F7.0.09	Process PID feedback value selection	0: Feedback channel 1 independently effective 1: Feedback channel 2 independently effective 2: Multifunctional terminal selection (Function No. 32) 3: Feedback channel 1+ feedback channel 2 4: Feedback channel 1- feedback channel 2 5: Feedback channel 1* feedback channel 2/100.0 6: 100.0* feedback channel 1/ feedback channel 2 7: Min.{ feedback channel 1, feedback channel 2} 8: Max{ feedback channel 1, feedback channel 2} 9: sqrt (feedback channel 1- feedback channel 2) 10: sqrt (feedback channel 1)+sqrt (feedback channel 2)	0	1	
F7.0.10	Process PID feedback channel 1	0: Analog input AI1 1: Analog input AI2 2: Analog input AI3 3: Analog input AI3 dual polarity PID feedback 4: Fin pulse input	0	1	
F7.0.11	Process PID feedback channel 2		0	1	
F7.0.12	Analog feedback quantity corresponding to 0% feedback (feedback channel 1)	0.0~[F7.0.13]/AI2: 0.0mA~[F7.0.13]	0.0	0.01	

Function Code	Name	Setting Range and Description	Factory Default	Minimum Unit	Change Limit
F7.0.13	Analog feedback quantity corresponding to 100% feedback (feedback channel 1)	[F7.0.12]~10.00V /AI2: [F7.0.12]~20.00mA	5.00	0.01	
F7.0.14	Analog feedback quantity corresponding to 0% feedback (feedback channel 2)	0.0~[F7.0.15]/AI2: 0.0mA~[F7.0.15]	0.0	0.01	
F7.0.15	Analog feedback quantity corresponding to 100% feedback (feedback channel 2)	[F7.0.14]~10.00V/AI2: [F7.0.14]~20.00mA	5.00	0.01	
F7.0.16	Feedback multiplication factor(e.g. calculate flow rate with differential voltage)	0.01~100.00	1.00	0.01	
F7.0.17	Proportional gain	0.0~100.00	2.00	0.01	
F7.0.18	Integration time	0.0, 0.1~1000.0Sec.	20.0	0.1	
F7.0.19	Differential coefficient	0.0, 0.01~10.00	0.0	0.01	
F7.0.20	Differential inertia filtering time	0.01~100.00Sec.	10.00	0.01	
F7.0.21	PID controller characteristics configuration (H)	<p>The unit: deviation polarity 0: Positive deviation 1: Negative deviation (negation)</p> <p>Tens: output polarity 0: Single polarity 1: Dual polarity (the symbol can be reversed)</p> <p>Hundreds: Action selection after the controller conditions is canceled. 0: PID control closed (automatically switch to next level of priority setting) 1: PID output held up and current setting status is maintained.</p>	0000	1	
F7.0.22	Permitted static deviation (relative 100% setting)	0.0~20.0%	5.0	0.1	
F7.0.23	PID output preset (at the time of output frequency as compared to the upper limiting frequency)	0.0~100.0 (%)	0.0	0.01	
F7.0.24	Preset hold time before PID starting	0.0~3600.0Sec.	0.0	0.1	

Function Code	Name	Setting Range and Description	Factory Default	Minimum Unit	Change Limit
F7.0.25	Actual sensor value (range) corresponding to 100% feedback	0.01~100.00	1.00	0.01	
F7.0.26	Actual sensor value corresponding to 0% feedback	-100.00~100.00	0.0	0.01	

6.29 Process PID multi-stage setting

Function Code	Name	Setting Range and Description	Factory Default	Minimum Unit	Change Limit
F7.1.27	Process PID multi-stage preset 1	-100.0~100.0 (%)	0.0	0.1	
F7.1.28	Process PID multi-stage preset 2	-100.0~100.0 (%)	0.0	0.1	
F7.1.29	Process PID multi-stage preset 3	-100.0~100.0 (%)	0.0	0.1	
F7.1.30	Process PID multi-stage preset 4	-100.0~100.0 (%)	0.0	0.1	
F7.1.31	Process PID multi-stage preset 5	-100.0~100.0 (%)	0.0	0.1	
F7.1.32	Process PID multi-stage preset 6	-100.0~100.0 (%)	0.0	0.1	
F7.1.33	Process PID multi-stage preset 7	-100.0~100.0 (%)	0.0	0.1	

6.30 Process PID sleep function (Effective when PID output is used as the frequency command)

Function Code	Name	Setting Range and Description	Factory Default	Minimum Unit	Change Limit
F7.2.34	Sleep function	0: Closed 1: Activated Activated when the multifunctional input selection is valid (Function No. 33)	0	1	
F7.2.35	Sleep frequency	0.0~[F0.1.21]	0.0	0.01	
F7.2.36	Sleep delay	0.1~3600.0Sec.	60.0	0.1	
F7.2.37	Awakening deviation (compared with the 100% set value)	0.0~100.0 (%)	25.0	0.1	
F7.2.38	Awakening delay	0.1~3600.0Sec.	60.0	0.1	

6.31 Revolution setting and feedback

Function Code	Name	Setting Range and Description	Factory Default	Minimum Unit	Change Limit
F8.0.00	Revolution setting channel (only applicable to VC and SVC mode)	0: Set by frequency setting parameter (F0.2.25) 1: Digital setting (F8.0.03) (maintained after stop and saved after power-off) 2: Panel shuttle potentiometer setting 3: Analog input AI1 4: Analog input AI2 5: Analog input AI3 (dual polarity) 6: Frequency signal input (Fin) 7: MODBUS Fieldbus set value 1 8: MODBUS Fieldbus set value 2 9: Virtual analog input SAI1 10: Virtual mode input SAI2	0	1	
F8.0.01	Minimum set signal corresponding revolution	0~60*[F0.1.21]/ pairs of motor poles (rpm)	0	1	
F8.0.02	Maximum set signal corresponding revolution (limited upper limit frequency)	0~60*[F0.1.21]/ pairs of motor poles (rpm)	1500	1	
F8.0.03	Revolution Digital setting (limited upper limit frequency)	0~60*[F0.1.21]/ pairs of motor poles (rpm)	0	1	
F8.0.04	Revolution feedback channel	0: Decoder (PG card needs to be equipped) 1: Single pulse input (Fin port) 2: Analog input AI1 3: Analog input AI2 4: Analog input AI3 (dual polarity)	0	1	×
F8.0.05	Pulse of decoder per revolution (PG)	1~8192	1024	1	×
F8.0.06	PG rotation direction (Effective for PG card)	0: Phase A is leading 1: Phase B is leading	0	1	×
F8.0.07	PG zero pulse (Z pulse)	0: Void 1: Effective	0	1	×
F8.0.08	Decoder type	0: ABZ incremental decoder 1: ABZUVW incremental type 2: SINCOS 3: Rotary transformer	0	1	×
F8.0.09	PG revolution check/control cycle	The Unit: PG revolution check cycle 1~5ms Tens: Reserve Hundreds: Revolution closed-loop control cycle (*0.25ms) 1~8	0101	1	
F8.0.10	Missing detection	The unit: Detection of speed	0001	1	×

Function Code	Name	Setting Range and Description	Factory Default	Minimum Unit	Change Limit
	and action of speed detection signal	measuring signal detection 0: Not detect 1: Detect and treat Tens: Act after missing of the speed detection signal 0: Fault alarm and free stop 1: Reserved			
F8.0.11	Judging time for speed detection signal missing	0.01~5.00Sec.	2.00	0.01	
F8.0.12	Wire breakage zero speed signal level (as compared to the maximum set speed)	0~20.0 (%)	0.0	0.1	
F8.0.13	Speed measuring loop wire breakage detection flexibility (as compared to the maximum set speed)	0.1~100.0	5.0	0.1	
F8.0.14	Detection revolution filtering time coefficient	0 (closed) , 1~50ms	0	1	
F8.0.15	The minimum revolution corresponding to the feedback signal (not PG)	0~30000rpm	0	1	
F8.0.16	The maximum revolution corresponding to the feedback signal (not PG)	0~30000rpm	1500	1	
F8.0.17	—	—	—	—	
F8.0.06	PG rotation direction (Effective for PG card)	0: Phase A is leading 1: Phase B is leading	0	1	×
F8.0.07	PG zero pulse (Z pulse)	0: Void 1: Effective	0	1	×
F8.0.08	Decoder type	0: ABZ incremental decoder 1: ABZUVW incremental type 2: SINCOS 3: Rotary transformer	0	1	×

6.32 Revolution closed-loop parameters

Function Code	Name	Setting Range and Description	Factory Default	Minimum Unit	Change Limit
F8.1.18	Controller parameter selection	0: Single PID parameter (the second group of parameters are effective separately) 1: Dual PID parameter (hysteresis switching) 2: Dual PID parameter (continuous switching)	2	1	
F8.1.19	PID parameter switching lower limiting revolution (ASR1 group parameter low revolution effective)	0~[F8.1.20]	100	1	
F8.1.20	PID parameter switching upper limiting revolution (ASR2group parameter high revolution effective))	[F8.1.19]~60*[F0.1.21]/pairs of motor poles (rpm)	300	1	
F8.1.21	Proportional gain 1 (ASR-P1)	0.10~2.00	1.00	0.01	
F8.1.22	Integration time 1 (ASR-I1)	0.0, 0.01~50.00 Sec.	1.50	0.01	
F8.1.23	Differential coefficient 1 (ASR-D1)	0.0, 0.01~10.00	0.0	0.01	
F8.1.24	Differential output filtering constant 1 (ASR-DT1)	0.10~5.00 Sec.	1.00	0.01	
F8.1.25	Proportional gain 2 (ASR-P2)	0.10~2.00	1.00	0.01	
F8.1.26	Integration time 2 (ASR-I2)	0.0, 0.01~50.00 Sec.	5.00	0.01	
F8.1.27	Differential coefficient 2 (ASR-D2)	0.0, 0.01~10.00	0.0	0.01	
F8.1.28	Differential output filtering constant 2 (ASR-DT2)	0.10~10.00 Sec.	1.00	0.01	
F8.1.29	Adjuster output upper limit amplitude (limited by transient positive torque)	0.0~250.0 (%)	180.0	0.1	
F8.1.30	Adjuster output lower limit amplitude (limited by transient negative torque)	-250.0~0.0 (%)	-180.0	0.1	
F8.1.31	Adjuster output filter time coefficient	0.0, 0.1 ~ 50.0mS	0.0	0.1	

6.33 Protection parameter

Function Code	Name	Setting Range and Description	Factory Default	Minimum Unit	Change Limit
F8.2.32	Excessive action of revolution deviation (DEV)	0: No action 1: Alarm free stop	0	1	×
F8.2.33	Over speed (OS) detection action	2: Alarm deceleration stop 3: Alarm continuing running	1	1	×
F8.2.34	Detected value of excessive revolution deviation (DEV)	0.0~50.0% (as compared to upper limiting frequency)	20.0%	0.1	
F8.2.35	Detection time of excessive revolution deviation (DEV)	0.0~10.00Sec.	10.00	0.01	
F8.2.36	Detected value of over speed (OS)	0.0~150.0% (as compared to upper limiting frequency)	120.0%	0.1	
F8.2.37	Detection time of over speed (OS)	0.0~2.00Sec.	0.10	0.01	
F8.2.38	SVC revolution estimated gain coefficient	0.10 ~ 10.00	1.00	0.01	

6.34 Torque control

Function Code	Name	Setting Range and Description	Factory Default	Minimum Unit	Change Limit
F8.3.39	Selection of torque control mode	0: Void 1: Effective 2: Multifunctional terminal selection effective (Function No. 34)	0	1	×
F8.3.40	Selection of torque command channel (selecting the command direction)	0: Digital setting (F8.3.41) 1: Panel shuttle potentiometer setting 2: Analog input AI1 3: Analog input AI2 4: Analog input AI3 5: Analog input AI3 (dual polarity) 6: Frequency signal input (Fin) 7: Process PID output 8: Reserved (0 by default) 9: MODBUS Fieldbus set value 1 10: MODBUS Fieldbus set value 2 11: Virtual analog input SAI1 12: Virtual mode input SAI2	0	1	
F8.3.41	Torque digital setting	-250.0~250.0 (%)	0.0	0.1	
F8.3.42	Torque value rising time (relative to rated torque)	0.0~50.000Sec.	0.01	0	
F8.3.43	Torque value decreasing time (relative to rated torque)	0.0~50.000Sec.	0.01	0	
F8.3.44	Revolution limiting setting (H)	The unit: FWD revolution (frequency) limiting setting source 0: Setting of FWD revolution limiting value (F8.3.45)	0000	1	

Function Code	Name	Setting Range and Description	Factory Default	Minimum Unit	Change Limit
		1: Determination of frequency Setting channel 1 (F0.2.25) Tens: Reserved Hundreds: REV revolution (frequency) limiting setting source 0: Setting of REV revolution limiting value (F8.3.46) 1: Reserved			
F8.3.45	FWD revolution limiting value	0~60*[F0.1.21]/pairs of motor poles (rpm)	1500	1	
F8.3.46	REV revolution limiting value	0~60*[F0.1.21]/pairs of motor poles (rpm)	1500	1	
F8.3.47	Setting of torque set value limit (H)	The unit: Minimum torque selection source (negative torque limit) 0: Minimum torque set value 1 (F8.3.48) 1: Minimum torque set value 2 (F8.3.49) 2: Multifunctional selection terminal setting 1 or 2 3: AI1 set value 4: AI2 set value 5: MODBUS Fieldbus set value 1 6: MODBUS Fieldbus set value 2 Tens: Reserved Hundreds: Maximum torque selection source 0: Maximum torque set value 1 (F8.3.50) 1: Maximum torque set value 2 (F8.3.51) 2: Multifunctional selection terminal setting 1 or 2 3: AI1 set value 4: AI2 set value 5: MODBUS Fieldbus set value 1 6: MODBUS Fieldbus set value 2		1	
F8.3.48	Minimum torque limit 1	-250.0~0.0 (%)	-200.0	0.1	
F8.3.49	Minimum torque limit 2	-250.0~0.0 (%)	-200.0	0.1	
F8.3.50	Maximum torque limit 1	0.0~250.0 (%)	200.0	0.1	
F8.3.51	Maximum torque limit 2	0.0~250.0 (%)	200.0	0.1	
F8.3.52	Torque zero offset	-25.0 ~ 25.0 (%)	0.0	0.1	

6.35 MODBUS fieldbus (Standard expansion card configuration)

Function Code	Name	Setting Range and Description	Factory Default	Minimum Unit	Change Limit
FA.0.00	Communication card connection and bus status	0: The communication card not connected 1: Standard MODBUS communication card connected 2: listen only status 3: Communication interrupted	—	1	R
FA.0.01	Configuration parameter	The unit: Baud rate selection 0: 1200 kbit/s 1: 2400 kbit/s 2: 4800 kbit/s 3: 9600 kbit/s 4: 19200 kbit/s 5: 38400 kbit/s 6: 76800 kbit/s Tens: Data format 0: 1-8-1-N, RTU 1: 1-8-1-E, RTU 2: 1-8-1-O, RTU 3: 1-8-2-N, RTU	0003	1	×
FA.0.02	Local device station address	0~247(0 stands for broadcasting address)	1	1	×
FA.0.03	Local device response delay	0~1000ms	5ms	1	
FA.0.04	Communication failure judging time	0.01~10.00Sec.	1.00	0.01	×
FA.0.05	Communication failure action	0: Deceleration stop 1: Run as per last received command	0	1	

6.36 Mapping access parameter

Function Code	Name	Setting Range and Description	Factory Default	Minimum Unit	Change Limit
FA.1.08	Mapping application parameter 1 (H)	F0.00 ~ FF.55	F0.29	1	
FA.1.09	Mapping application parameter 2 (H)	F0.00 ~ FF.55	F0.29	1	
FA.1.10	Mapping application parameter 3 (H)	F0.00 ~ FF.55	F0.29	1	
FA.1.11	Mapping application parameter 4 (H)	F0.00 ~ FF.55	F0.32	1	
FA.1.12	Mapping application parameter 5 (H)	F0.00 ~ FF.55	F0.32	1	
FA.1.13	Mapping application parameter 6 (H)	F0.00 ~ FF.55	F0.32	1	
FA.1.14	Mapping status parameter 1 (H)	d0.00 ~ d1.49	d0.00	1	
FA.1.15	Mapping status parameter 2 (H)	d0.00 ~ d1.49	d0.01	1	
FA.1.16	Mapping status parameter 3 (H)	d0.00 ~ d1.49	d0.02	1	
FA.1.17	Mapping status parameter 4 (H)	d0.00 ~ d1.49	d0.03	1	
FA.1.18	Mapping status parameter 5 (H)	d0.00 ~ d1.49	d0.04	1	×
FA.1.19	Mapping status parameter 6 (H)	d0.00 ~ d1.49	d0.05	1	×
FA.1.20	Mapping status parameter 7 (H)	d0.00 ~ d1.49	d0.06	1	×
FA.1.21	Mapping status parameter 8 (H)	d0.00 ~ d1.49	d0.07	1	×
FA.1.22	Mapping status parameter 9 (H)	d0.00 ~ d1.49	d0.08	1	×
FA.1.23	Mapping status parameter 10 (H)	d0.00 ~ d1.49	d0.09	1	×

6.37 Communication linkage synchronous control

Function Code	Name	Setting Range and Description	Factory Default	Minimum Unit	Change Limit
FA.2.25	Linkage synchronous control options (H)	<p>The unit: Selection of linkage function 0: Void 1: The device is the slave device 2: The device is the master device</p> <p>Tens: Linkage target value 0: Proportional linkage of frequency /revolution set value 1: Proportional linkage of frequency /revolution integrator output value</p> <p>Hundreds: linkage command (slave device parameter) 0: Independent control of slave device (start and stop not linked) 1: Start and stop command linked 2: Start-stop/jog linked 3: Start-stop/jog/excitation linked 4: Start-stop/jog/excitation /DC bind-type brake/DC braking linked</p> <p>Kilobit: Linkage setting selection 0: The unit option of the parameter is effective 1: External terminal switching (Function No. 39)</p>	0310	1	×
FA.2.26	Correction coefficient of communication setting for this device.	0.010~10.000	1.000	0.001	
FA.2.27	Fine adjustment source for linkage proportion coefficient	0: No fine adjustment 1: Analog input AI1 2: Analog input AI2 3: Analog input AI3	0	1	
FA.2.28	Slave device offset frequency/Revolution	0: No offset 1: Determined by frequency setting source 1 2: Determined by frequency setting source 2	0	1	
FA.2.29	Linkage balancing function	0: Void 1: Current balancing 2: Torque balancing 3: Power balancing	0	1	
FA.2.30	Linkage balancing gain	0.001~10.000	1.000	0.001	

6.38 Expansion multifunctional input terminal

Function Code	Name	Setting Range and Description	Factory Default	Minimum Unit	Change Limit
Fb.0.00 ~ Fb.0.07	Expand multifunctional input terminal EDI1~ED8 (effective when expansion components are inserted)	0~96	0	1	x
Fb.0.08	Multifunctional Terminals Filter time	1ms~50ms			
Fb.0.09	Effective level of expansion multifunctional input terminal (H)	The unit: EDI1~EDI4 terminal 0~F: 4-bit binary system, bit=0 power-on effective, 1 Disconnection effective Tens: EDI5~EDI8 terminal The same as above Hundreds: Reserved Kilobit: Reserved	0000	1	x

6.39 Expansion multifunctional output terminal

Function Code	Name	Setting Range and Description	Factory Default	Minimum Unit	Change Limit
Fb.1.10 ~ Fb.1.17	Expand multifunctional input terminal EDO1~EDO8 (effective when corresponding expansion I/O components are connected)	0~62	0	1	

6.40 Zero-speed torque and position control

Function Code	Name	Setting Range and Description	Factory Default	Minimum Unit	Change Limit
Fb.2.18	Automatic shift frequency	0.0 ~ 5.00Hz	1.00	0.01	
Fb.2.19	Automatic shift switching cycle	0.10 ~ 2.00Sec.	0.30	0.01	
Fb.2.20	Zero frequency torque holdup (DC bind-type brake preferred)	0: Void 1: Bind-type brake torque effective 2: Position locking (PG feedback VC mode)	0	1	x
Fb.2.21	Position locking gain	0.01 ~ 10.00	1.00	0.01	
Fb.2.22	PG speed shaft propulsion distance per revolution	0.001 ~ 50.000mm	0.500	0.001	

6.41 Virtual input and output

Function Code	Name	Setting Range and Description	Factory Default	Minimum Unit	Change Limit
FF.0.00	FF configuration parameter locking function (H)	<p>The unit: FF parameter group modification forbidden 0: Forbidden (effective for no display) 1: Permitted</p> <p>Tens: Reserved Hundreds: Reserved</p> <p>Kilobit: Initialization of FF parameter group 0: Forbidden 1: Permitted</p>	0000	1	
FF.0.01	Definition of virtual output node (SDO1)	0~62	0	1	
FF.0.02	Definition of virtual output node (SDO2)	0~62	0	1	
FF.0.03	Definition of virtual output node (SDO3)	0~62	0	1	
FF.0.04	Definition of virtual output node (SDO4)	0~62	0	1	
FF.0.05	Definition of virtual output node (SDO5)	0~62	0	1	
FF.0.06	Definition of virtual output node (SDO6)	0~62	0	1	
FF.0.07	Definition of virtual output node (SDO7)	0~62	0	1	
FF.0.08	Definition of virtual output node (SDO8)	0~62	0	1	
FF.0.09	Definition of virtual input function (SDI1)	0~96	0	1	×
FF.0.10	Definition of virtual input function (SDI2)	0~96	0	1	×
FF.0.11	Definition of virtual input function (SDI3)	0~96	0	1	×
FF.0.12	Definition of virtual input function (SDI4)	0~96	0	1	×
FF.0.13	Definition of virtual input function (SDI5)	0~96	0	1	×
FF.0.14	Definition of virtual input function (SDI6)	0~96	0	1	×
FF.0.15	Definition of virtual input function (SDI7)	0~96	0	1	×
FF.0.16	Definition of virtual input function (SDI8)	0~96	0	1	×
FF.0.17	Virtual output- input connection polarity (H)	<p>The unit: SDO1-SDI1 0: Homopolar connection 1: Antipolar connection</p>	0000	1	×

Function Code	Name	Setting Range and Description	Factory Default	Minimum Unit	Change Limit
		Tens: SDO2-SDI2 0: Homopolar connection 1: Antipolar connection Hundreds: SDO3-SDI3 0: Homopolar connection 1: Antipolar connection Kilobit: SDO4-SDI4 0: Homopolar connection 1: Antipolar connection			
FF.0.18	Virtual output- input connection polarity (H)	The unit: SDO5-SDI5 0: Homopolar connection 1: Antipolar connection Tens: SDO6-SDI6 0: Homopolar connection 1: Antipolar connection Hundreds: SDO7-SDI7 0: Homopolar connection 1: Antipolar connection Kilobit: SDO8-SDI8 0: Homopolar connection 1: Antipolar connection	0000	1	x

6.42 Protection function configuration parameters

Function Code	Name	Setting Range and Description	Factory Default	Minimum Unit	Change Limit
FF.1.19	Protection action configuration 1 (H)	The unit: Operation undervoltage protection 0: No action 1: Act Tens: Output grounding protection 0: No action 1: Act Hundreds: Output voltage phase shortage protection (Void for single camera) 0: No action 1: Trip and stop 2: Nonstop alarm Kilobit: Output current phase shortage or unbalancing protection 0: No action 1: Trip and stop 2: Nonstop alarm	1111	1	
FF.1.20	Protection action configuration 2 (H)	The unit: Temperature sensor fault 0: No action 1: Trip and stop	1111	1	

Function Code	Name	Setting Range and Description	Factory Default	Minimum Unit	Change Limit
		2: Nonstop alarm Tens: Inverter overheat alarm 0: Closed 1: Act Hundreds: Input voltage unbalancing protection (Void for single camera) 0: No action 1: Trip and stop 2: Nonstop alarm Kilobit: Motor overtemperature protection 0: No action 1: Trip and stop 2: Nonstop alarm			
FF.1.21	Protection action configuration 3 (H)	The unit: Relay action fault protection 0: No action 1: Act Tens: Internal data memory abnormality protection 0: No action 1: Act Hundreds: Inverter undervoltage operation alarm 0: Closed 1: Act Kilobit: Reserved	0111	1	
FF.1.22	Protection action configuration 4 (H)	The unit: Drive protection action 0: Closed 1: Act Tens: Reserved Hundreds: A and B pulse reverse connection protection of PG card 0: Closed 1: Act	0101	1	
FF.1.23	Protection action configuration 5 (H)	The Unit: Alarm information shielding 0: Closed 1: Act (alarm information not displayed) Tens: Reserve	0	1	
FF.1.24	—	—			

6.43 Correction parameter

Function Code	Name	Setting Range and Description	Factory Default	Minimum Unit	Change Limit
FF.2.25	AI1 zero offset adjustment	-0.500~0.500V	0.0	0.001	
FF.2.26	AI1 gain correction	0.950~1.050	1.000	0.001	
FF.2.27	4mA offset adjustment for AI2	-0.500~0.500mA	0.0	0.001	
FF.2.28	AI2 gain correction	0.950~1.050	1.000	0.001	
FF.2.29	AI3 zero offset adjustment	-0.500~0.500V	0.0	0.001	
FF.2.30	AI3 gain correction	0.950~1.050	1.000	0.001	
FF.2.31	AO1 zero offset correction	-0.500~0.500V	0.0	0.001	
FF.2.32	AO1 gain correction	0.950~1.050	1.000	0.001	
FF.2.33	AO2 zero offset correction	-0.500~0.500V	0.0	0.001	
FF.2.34	AO2 gain correction	0.950~1.050	1.000	0.001	
FF.2.35	Undervoltage action level	320~450V	320	1	x
FF.2.36	Correction coefficient of DC side voltage detection value	0.950~1.050	1.000	0.001	

6.44 Special functional parameters

Function Code	Name	Setting Range and Description	Factory Default	Minimum Unit	Change Limit
FF.3.37	Setting of torque ultimate limiting mode (H)	<p>The unit: Constant torque area torque limitation 0: Only limited by torque limiting parameter (including Revolution PID output limit) 1: Also limited by acceleration and deceleration current level and maximum permitted current.</p> <p>Tens: Reserved</p> <p>Hundreds: Constant power area torque limitation 0: Treated the same as the constant torque area 1: Simultaneously adjusted as per constant power algorithm</p>	0101	1	
FF.3.38	Current closed-loop proportional gain	0.10 ~ 10.00	1.00	0.01	
FF.3.39	Current closed-loop integration time constant	0.10 ~ 10.00 (Sec.)	1.00	0.01	
FF.3.40	Total leakage inductance compensation coefficient	0.10 ~ 10.00	1.00	0.01	

6.45 Other configuration parameters

Function Code	Name	Setting Range and Description	Factory Default	Minimum Unit	Change Limit
FF.4.41	Cooling fan control (H)	<p>The unit: Soft start function (effective for model 4T0370 and below) 0: No action 1: Act</p> <p>Tens: Air volume auto adjustment (effective for model 4T0370 and below) 0: No action 1: Act</p> <p>Hundreds: Start time 0: Start immediately after power-on 1: Start after running</p> <p>Kilobit: Reserved</p>	0101	1	
FF.4.42	Operating panel control options	<p>The unit: Panel REV/JOG key function selection 0: REV (REV running key) 1: JOG (FWD jog key)</p> <p>Tens: Reserved</p> <p>Hundreds: Reserved</p> <p>Kilobit: Panel control selection (except STOP key) 0: Standard panel interface control (can be connected to monitoring panel via RS485) 1: RS485 port external panel control(standard panel, only for monitoring) 2: Multifunctional terminal switching (Function No. 40)</p>	0000	1	×
FF.4.43	Special function configuration (H)	<p>The unit: Motor parameter identification auto-start 0: Forbidden 1: Permitted</p> <p>Tens: Voltage vector composition mode 0: Three-phase composition 1: Two-phase composition</p> <p>Hundreds: Voltage small pulse shielding 0: Void 1: Effective</p> <p>Kilobit: Reserved</p>	0001	1	
FF.4.44	Asynchronous motor parameter adaptive correction	<p>The unit: Stator resistance 0: Forbidden 1: Permitted</p> <p>Tens: Total leakage inductance 0: Forbidden 1: Permitted</p> <p>Hundreds: Rotor time constant 0: Void 1: Effective</p> <p>LED Kilobit: Torque increasing function</p>	1011	1	

Function Code	Name	Setting Range and Description	Factory Default	Minimum Unit	Change Limit
		0: Void 1: Effective (gradually increasing)			
FF.4.45	Random reference value	0~65535		1	R
FF.5.46 ~ FF.5.55	Reserved				

6.46 Historical fault recording

Function Code	Name	Setting Range and Description	Factory Default	Minimum Unit	Change Limit
dE.0.00	Last time fault recording	-	-	-	R/I
dE.0.01	Historical fault 1	-	-	-	R/I
dE.0.02	Historical fault 2	-	-	-	R/I
dE.0.03	Historical fault 3	-	-	-	R/I
dE.0.04	Historical fault 4	-	-	-	R/I
dE.0.05	Historical fault 5	-	-	-	R/I
dE.0.06	Historical fault 6	-	-	-	R/I
dE.0.07	Historical fault 7	-	-	-	R/I

6.47 Operation status at the last fault

Function Code	Name	Setting Range and Description	Factory Default	Minimum Unit	Change Limit
dE.0.08	Operating frequency (rotor synchronous frequency)	-3000.0~300.00Hz	0	0.01	R/I
dE.0.09	Output current	0.0~3000.0A	0	0.1	R/I
dE.0.10	Output voltage	0~1000V	0	1	R/I
dE.0.11	Detection motor revolution (when revolution sensor is equipped)	0~30000rpm	0	1	R/I
dE.0.12	Voltage at the DC side	0~1000V	0	1	R/I
dE.0.13	Output torque	-300.0~ 300.0%	0	0.1%	R/I
dE.0.14	Target frequency	0.0~300.00Hz	0	0.01	R/I
dE.0.15	Equipment maximum temperature	0.0~150.0	0	0.1℃	R/I
dE.0.16	Command status	The unit: 0: Stop command 1: Running command Tens: Reserved Hundreds: Reserved Kilobit: Reserved	0000	1	R/I

Function Code	Name	Setting Range and Description	Factory Default	Minimum Unit	Change Limit
dE.0.17	Inverter operation status	<p>The unit: Operation mode 0: VF mode 1: Open-loop vector speed 2: Closed-loop vector speed 3: Open-loop torque control 4: Closed-loop torque control</p> <p>Tens: Operation status 0: Stop 1: Start acceleration 2: Stop deceleration 3: Decreasing frequency and deceleration 4: Steady operation</p> <p>Hundreds: Electric/braking status 0: Electric operation 1: Power generation operation</p> <p>Kilobit: Limit suppression 0: No action 1: Overcurrent suppression action 2: Overvoltage suppressor action 3: Undervoltage suppression action</p>	0000	1	R/I
dE.0.18	Accumulative startup running time at the last fault	0~65535	65535	1H	R/I
dE.0.19	Startup running interval between the last two faults	0~65535	65535	1H	R/I
dE.0.20	Synchronous output frequency	-300.00~300.00Hz	0	0.01	R/I

6.48 Basic status parameter

Function Code	Name	Value Range and Description	Factory Default	Minimum Unit	Change Limit
d0.0.00	Output frequency and direction (rotor synchronous frequency)	-300.0Hz ~ 300.00Hz		0.01Hz	R
d0.0.01	Motor revolution and direction	-30000~30000rpm		1rpm	R
d0.0.02	Output current	0.0~ 6000.0A		0.1A	R
d0.0.03	Output torque	-300.0~300.0%		0.1%	R
d0.0.04	Output voltage	0~500V		1V	R
d0.0.05	Output power	-1000.0~1000.0KW		0.1KW	R

Function Code	Name	Value Range and Description	Factory Default	Minimum Unit	Change Limit
d0.0.06	Device body maximum temperature	0~150.0℃		0.1℃	R
d0.0.07	Voltage at DC side	0~1000V		1V	R
d0.0.08	Inverter running status	<p>The unit: Operation mode 0: VF mode 1: Open-loop vector speed 2: Closed-loop vector speed 3: Open-loop torque control 4: Closed-loop torque control 5: V-F separated control</p> <p>Tens: Operation status 0: Stop 1: Start acceleration 2: Stop deceleration 3: Decreasing frequency and deceleration 4: Steady operation</p> <p>Hundreds: Electric/braking status 0: Electric operation 1: Power generation operation</p> <p>Kilobit: Limit suppression 0: No action 1: Overcurrent suppression action 2: Overvoltage suppressor action 3: Undervoltage suppression action</p>		1	R
d0.0.09	Frequency setting channel command value (frequency)	-300.00Hz ~ 300.00Hz		0.01Hz	R
d0.0.10	Revolution Setting channel command value (Revolution)	-30000~30000rpm		1rpm	R
d0.0.11	Torque command value (set input)	-300.0~300.0%		0.1%	R
d0.0.12	Target operating frequency (integrator input)	-300.0Hz ~ 300.00Hz		0.01Hz	R
d0.0.13	Target running revolution (integrator input)	-30000~30000rpm		1rpm	
d0.0.14	Speed adjuster deviation	-3200~3200rpm		1rpm	
d0.0.15	Speed adjuster output	-300.0~300.0(%)		0.1%	
d0.0.16	Process PID setting	-100.0~100.0(%)		0.1%	
d0.0.17	Process PID feedback	-100.0~100.0(%)		0.1%	
d0.0.18	Process PID deviation	-100.0~100.0(%)		0.1%	

Function Code	Name	Value Range and Description	Factory Default	Minimum Unit	Change Limit
d0.0.19	Process PID output	-100.0~100.0(%)		0.1%	
d0.0.20~ d0.0.23	Reserve				
d0.0.24	Accumulative running time (H)	0~65535h		1h	
d0.0.25	Accumulative power-on time (H)	0~65535h		1h	
d0.0.26	Power-on (hh.mm.s) cycling timing	00.00.0~23.59.9		1	
d0.0.27	Kilowatt-hour counter (low)	0~1000.0KWh		0.1KWh	
d0.0.28	Kilowatt-hour counter (high)	0~60000KKWh		1KKWh	
d0.0.29	Megawatt hour counter	0~60000MW		1MW	

6.49 Auxiliary status parameter

Function Code	Name	Value Range and Description	Factory Default	Minimum Unit	Change Limit
d0.1.30	Frequency setting source 1 set value	0.0~300.00Hz	-	0.01Hz	R
d0.1.31	Frequency setting source 2 set value	0.0~300.00Hz	-	0.01Hz	R
d0.1.32	Frequency/revolution integrator output	-300.0~300.00Hz	-	0.01Hz	R
d0.1.33	Stator synchronous frequency	-300.0Hz ~ 300.00Hz	-	0.01Hz	R
d0.1.34	Actually measured revolution value	-30000~30000rpm	-	1rpm	R
d0.1.35	Inverter overload integrator value	0~1020	-	1	R
d0.1.36	Process PID set variable (physical quantity)	0.01~60000	-	0.01	R
d0.1.37	Process PID feedback variable(physical quantity)	0.01~60000	-	0.01	R
d0.1.38	Reserve		-		--
d0.1.39	Reserve		-		--
d0.1.40	Torque current	-3000.0~3000.0A	-	0.1A	R
d0.1.41	Excitation current	0.0~3000.0A	-	0.1A	R
d0.1.42	Device body temperature detection 1	0~150.0℃	-	0.1℃	R
d0.1.43	Reserve				
d0.1.44	Reserve				
d0.1.45	Reserve				

6.50 MODBUS fieldbus status parameter (Standard expansion I/O board)

Function Code	Name	Value Range and Description	Factory Default	Minimum Unit	Change Limit
d0.2.46	Bus communication set value 1	-10000~10000		1	R
d0.2.47	Bus communication set value 2	-30000~30000		1	R
d0.2.48	Bus command word 1 (HEX)	0~0FFFFH		1	R
d0.2.49	Bus command word 2 (HEX)	0~0FFFFH		1	R
d0.2.50	Bus command word 1 (HEX)	0~0FFFFH		1	R
d0.2.51	Bus command word 2 (HEX)	0~0FFFFH		1	R
d0.2.52	Total quantity of bus information	0~65535		1	R
d0.2.53	Number of bus CRC check errors	0~65535		1	R
d0.2.54	Number of error data accepted by bus	0~65535		1	R
d0.2.55	Number of effective data of bus	0~65535		1	R

6.51 Terminal status and variable

Function Code	Name	Value Range and Description	Factory Default	Minimum Unit	Change Limit
d1.0.00	Terminal input (DI1~DI10)	Segment identifier (see Figure 6-1)	-	-	R
d1.0.01	Terminal input (EDI1~EDI10)	Segment identifier	-	-	R
d1.0.02	Pulse input (Fin)	0.0~100.00KHz		0.01	R
d1.0.03	Analog input AI1	0.00~10.00V		0.01	R
d1.0.04	Analog input AI2	0.00~20.00mA		0.01	R
d1.0.05	Analog input AI3	-10.00~10.00V		0.01	R
d1.0.06	Digital signal output (DO1~DO4, EDO1~ EDO6)	Segment identifier	-	-	R
d1.0.07	Relay contact output (RO1~RO4, ERO1~ERO6)	Segment identifier	-	-	R
d1.0.08	Frequency output Fout (indicating the duty ratio in the case of PWM signal output)	0.0~100.0KHz		0.01	R
d1.0.09	Analog output AO1	0.00~10.00V		0.01	R
d1.0.10	Analog output AO2	0.00~10.00V		0.01	R



Figure 6-1 Terminal Effective Sketch



As shown in figure 6-1, DI2, DI3, DI7, DI9 terminal input is in effective status, and other terminals are at void status.

6.52 Counter timer value

Function Code	Name	Value Range and Description	Factory Default	Minimum Unit	Change Limit
d1.1.11	Counter 1 current value	0~65535		1	R
d1.1.12	Counter 2 current value	0~65535		1	R
d1.1.13	Timer 1 current value	0~65535		1	R
d1.1.14	Timer 2 current value	0~65535		1	R
d1.1.15	Timer 3 current value	0~65535		1	R

6.53 Positioning status parameter

Function Code	Name	Value Range and Description	Factory Default	Minimum Unit	Change Limit
d1.2.16	Spindle (PG installation shaft) position angle	0~359.9		0.1	R
d1.2.17	Spindle (PG installation shaft) travelling circle number	0~65536		1	R
d1.2.18	Accumulative number of position pulse (low)	0~65535		1	R
d1.2.19	Accumulative number of position pulse (middle)	0~65535		1	R
d1.2.20	Progressive distance	0.0~5000.0mm		0.1	R

6.54 Equipment information

Function Code	Name	Value Range and Description	Minimum Unit	Factory Default	Change limit
d1.4.40	Expansion module connection information	The unit: Reserved Tens: Standard expansion board 0: Not connected 1: Connected Hundreds: Functional expansion board 1 0: Not connected 1~F: Connected (the value stands for the type of expansion board) Kilobit: Functional expansion board 2 0: Not connected 1~F: Connected (the value stands for the type of expansion board)	1	—	R
d1.4.41	Total quantity of panel communication information	0~65535	1	—	R
d1.4.42	Number of panel communication CRC check errors + number of errors accepted	0~65535	1	—	R

Function Code	Name	Value Range and Description	Minimum Unit	Factory Default	Change limit
d1.4.43	Number of effective data of panel communication	0~65535	1	—	R
d1.4.44	Reserve			—	--
d1.4.45	Equipment capacity	0.1~1000.0KW	0.1KW	—	R
d1.4.46	Motherboard program version (H)	5100~5999	1	—	R
d1.4.47	Reserve			—	--
d1.4.48	Motherboard check date (H)	2009~2100	1	—	R
d1.4.49	Motherboard check date (H)	0101~1231	1	—	R
d1.4.50	Motherboard check serial number	0 ~ 50000	1	—	R

Exhibit 1 Comparison table of multifunctional terminal (DI/EDI/SDI) functions

S/N	Function	S/N	Function
0	No function	1	Multi-speed control 1
2	Multi-speed control 2	3	Multi-speed control 3
4	Multi-speed control 4	5	FWD jog
6	REV jog	7	Forward (FWD) running command terminal
8	Reverse (REV)running command terminal	9	Acceleration and deceleration time selection 1
10	Acceleration and deceleration time selection 2	11	Running command switching
12	Frequency command switching	13	Fault resetting input (RESET)
14	Emergency stop (EMS)	15	Frequency or Process PID set value ascending (UP)
16	Frequency or Process PID set value descending (DW)	17	UP/DW set frequency clear
18	External equipment fault	19	Three-line running control
20	Stop DC braking command	21	Acceleration and deceleration forbidden
22	Process PID effective	23	Simple PLC multi-stage running effective
24	Swing frequency running effective	25	Reserve
26	Simple PLC multi-stage running status (when stopping) resetting	27	Swing frequency status resetting (effective when stopping)
28	Multi-stage process PID giving terminal 1	29	Multi-stage Process PID giving terminal 2
30	Multi-stage process PID giving terminal 3	31	Process PID setting selection (switching)
32	Process PID feedback selection (switching)	33	Process PID sleep activation
34	Torque/speed control mode switching	35	Minimum torque limiting set value selection
36	Maximum torque limiting set value selection	37	Overvoltage suppression input
38	Load dynamic balancing effective	39	Linkage setting conditions effective
40	RS485 external/Standard operation panel control switching	41	Reserved
42	Start permission	43	Running permission
44	Counter 1 clock terminal	45	Counter 2 clock terminal
46	Counter 1 trigger signal	47	Counter 2 trigger signal

S/N	Function	S/N	Function
48	Counter 1 resetting terminal	49	Counter 2 resetting terminal
50	Counter 1 gated signal	51	Counter 2 gated signal
52	Timer 1 trigger signal	53	Timer 2 trigger signal
54	Timer 3 trigger signal	55	Timer 1 resetting
56	Timer 2 resetting	57	Timer 3 resetting
58	Timer 1 gated signal	59	Timer 2 gated signal
60	Timer 3 gated signal	61	Single pulse accumulative length value resetting
62	Motor temperature detection contact input	63	Reserved
64	Reserved	65	Magnetic flux brake
66	Position pulse counting (PG pulse counting accumulation) resetting	67	Automatic shifting (Spindle shifting jog running)
68~80	Reserved	81~96	Reserve (for function expansion card)
97	0.10~100.00KHz pulse input port (Fin effective)	98	1.0~1000.0Hz pulse input port (Fin effective)

Exhibit 2 Comparison table of multifunctional output terminal (DO/EDO/SDO)

S/N	Function	S/N	Function
0	No definition	1	Inverter running ready (normal voltage, no emergency stop input)
2	Inverter is running	3	Equipment normal (fault-free running)
4	Equipment fault (trip)	5	Equipment alarm
6	Equipment fault or alarm	7	REV running
8	Running command input (irrelevant with start or running signal)	9	Running with zero frequency
10	Speed not at zero	11	Inverter undervoltage stop
12	Terminal control effective	13	In the process of acceleration running
14	In the process of deceleration running	15	Braking power generation running status
16	Determined by standard MODBUS Fieldbus	17	Determined by extended communication module
18	Reserved	19	Completion of current stage of multi-stage running (0.5s pulse)
20	Multi-stage running completed (0.5S pulse)	21	Multi-stage running completed (continuous level output)
22	Multi-stage running cycle completed (0.5Spulse)	23	Swing frequency upper and lower limit
24	Decoder direction positive (A pulse surpassing B pulse)	25	Decoder direction negative (A behind B)
26	Monitor 1 input variable below the lower limit (Void when above the upper limit)	27	Monitor 1 input variable above the upper limit (void when below the lower limit)
28	Monitor 1 input variable between the upper limit and the lower limit	29	Monitor 2 variable below the lower limit (void when above the upper limit)
30	Monitor 2 input variable above the upper limit (void when below the lower limit)	31	Monitor 2 input variable between the upper limit and the lower limit
32	Monitor 3 input variable below the lower limit (void when above the upper limit)	33	Monitor 3 input variable above the upper limit (void when below the lower limit)
34	Monitor 3 input variable between the upper limit and the lower limit	35	Reserved
36	Analog input AI1 wire breakage detection effective	37	Analog input AI2 wire breakage detection effective
38	Analog input AI3 wire breakage detection effective	39	Reserved
40	Counter 1 output signal 1	41	Counter 1 output signal 2

S/N	Function	S/N	Function
42	Counter 2 output model 1	43	Counter 2 output signal 2
44	Timer 1 output signal 1	45	Timer 1 output signal 2
46	Timer 2 output signal 1	47	Timer 2 output signal 2
48	Timer 3 output signal 1	49	Timer 3 output signal 2
50~54	Retained for extension modules	55	DI1 terminal status effective
56	DI2 terminal status effective	57	DI3 terminal status effective
58	DI4 terminal status effective	59	DI5 terminal status effective
60	DI6 terminal status effective	61	DI7 terminal status effective
62	DI8 terminal status effective	63	Terminal as frequency output (only applicable to DO3/Fo terminal)



Direction will not be considered for comparison of monitor variables.

Exhibit 3 Monitor variable comparison table

S/N	Monitoring Parameter Variable	100% full-scale output
0	Output frequency (rotor synchronous frequency)	Upper limiting frequency
1	Motor Revolution	Upper limiting frequency *60/pairs of motor poles
2	Output current	250%* Inverter rated current
3	Output torque	300% rated torque
4	Output voltage	Motor rated voltage (reference voltage in VF mode)
5	Output power	2* motor rated power
6	Maximum temperature of the equipment	150.0°C
7	Voltage at the DC side	1000V (single phase 500V)
8	Motor temperature/ PTC resistance	500.0°C/5000 Ohm
9	Frequency setting channel set value	Upper limiting frequency
10	Speed command	Upper limiting frequency *60/pairs of motor poles
11	Torque command	300% rated torque
12	Target operating frequency	Upper limiting frequency
13	Difference between frequency (revolution) output and set value	Upper limiting frequency (revolution)
14	Speed adjuster deviation	Upper limiting frequency *60/pairs of motor poles
15	Speed adjuster output	300.0%

S/N	Monitoring Parameter Variable	100% full-scale output
16	Process PID setting	100.0%
17	Process PID feedback	100.0%
18	Process PID deviation value	200.0%
19	Process PID output	100.0%
20~23	Reserved	--
24	AI1 input (0.00~10.00)	10.00V
25	AI2 input (0.00~20.00)	20.00mA
26	AI3 input (-10.00~10.00)	10.00V
27	Fin input	Maximum input frequency
28	Current liner speed (Fin calculation)	Maximum permitted liner speed
29	Accumulative counted length (liner speed accumulation)	Maximum counted length
30	Counter 1 value	Counter 1 set value 2
31	Counter 2 value	Counter 2 set value 2
32	Timer 1 value	Timer 1 timing cycle
33	Timer 2 value	Timer 2 timing cycle
34	Timer 3 value	Timer 3 timing cycle
35	Built-in Fieldbus set value 1	10000
36	Extended communication module set value 1	10000
37	Built-in Fieldbus set value 2	30000
38	Extended communication module set value 2	30000
39~44	Reserved	
45	Fixed output (current or voltage)	20.00mA (10.00V)

Chapter 7 Function Details

Remark: Unless otherwise especially instructed, the status of terminals will be defined under positive logic conditions (“ON” terminals effective, and “OFF” terminals void).

7.1 System management (Group F0.0)

Group F0.0 parameters are especially used to define system control parameters, e.g. locking, initializing, motor type and control mode as well as display of monitoring parameters, etc.

F0.0.00 Macro parameters (H)	Setting range: 0000~2006	Factory default: 0000
-------------------------------------	---------------------------------	------------------------------

Macro parameters include application macro, system macro and special configuration macro; the application macro allows for conveniently setting and curing multiple common parameters and simplifying parameter setting for general applications; the system macro allows for conveniently switching equipment’s work mode (e.g. switching between high and low frequency operation mode) and automatically defining partial parameters; the special macro allows for internal integration and settings for special functions or parameters with one key according to typical industrial applications.

Macro parameters are not influenced by the initializing parameter F0.0.07 and partial macro-related parameters are locked at specific value or within specific range.

The unit: Application macro (0-F)

0: Void

Customized settings, all parameters can be customized without being influenced by the application macro parameters.

1: Digital setting of panel operation

Refer to Figure 7-1 for the application wiring diagram, and refer to Table 7-1 for macro-related parameters.

2: Shuttle setting panel operation

Refer to Figure 7-1 for the application wiring diagram, and refer to Table 7-1 for macro-related parameters.

3: Two-Line Control 1/AI1 Setting

Refer to Figure 7-2-A for the application wiring diagram, and refer to Table 7-1 for macro-related parameters.

4: Two-Line Control 2/AI1 Setting

Refer to Figure 7-2-B for the application wiring diagram, and refer to Table 7-1 for macro-related parameters.

5: Three-line control 1/AT1 setting

Refer to Figure 7-3 for the application wiring diagram, and refer to Table 7-1 for macro-related parameters.

6: Machine tool spindle drive macro / AI1 setting.

Refer to Figure 7-4 for the application wiring diagram, and refer to Table 7-1 for macro-related parameters.

Table 7-1: Table Application Macro Association Self-Setting Parameters

Parameters	Applicati on Macro 1	Applicati on Macro 2	Applicati on Macro 3	Applicati on Macro 4	Applicati on Macro 5	Remarks
F0.2.25	2 (0~2)	3	9	9	9	Locked
F0.3.33	0	0	1	1	1	Locked
F0.3.35	—	—	0	1	2	Locked
F0.4.37	0	0	0	0	0	Locked
F0.4.38	0	0	0	0	0	Locked
F3.0.01	—	—	—	—	19	Locked
F3.0.02	—	—	7	7	7	Locked
F3.0.03	—	—	8	8	8	Locked
F3.0.04	13	13	13	13	13	Locked
F6.1.15	0	0	0	0	0	Relocatable
F6.2.46	0	0	0	0	0	Relocatable
F7.0.00	0	0	0	0	0	Relocatable
F8.0.00	0	0	0	0	0	Relocatable
FA.2.25	0	0	0	0	0	Relocatable

Figure 7-1 Wiring Diagram for Panel Operation Digital/Shuttle Setting

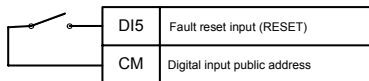

Figure 7-2-A Two-Line Control 1/AI1 Setting Wiring Diagram

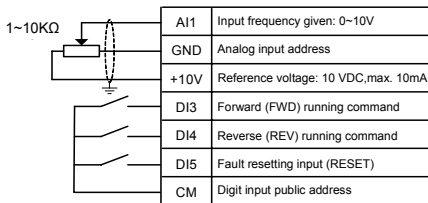

Figure 7-2-B Two-Line Control 2/AI1 Setting Wiring Diagram

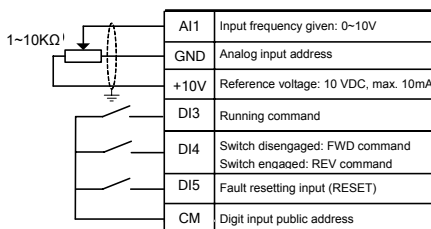

Figure 7-3 Three-Line Control 1/AI1 Setting Wiring Diagram

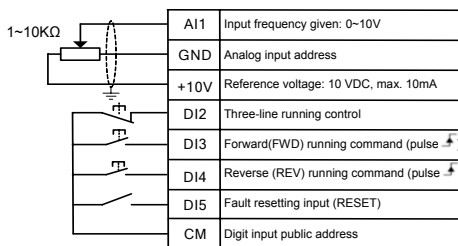
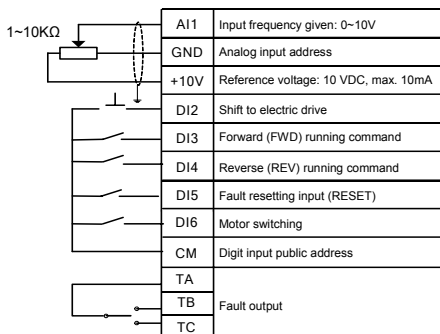

Figure 7-4 Driven by machine tool spindle / AI1 preset wiring diagram



Macro-related parameters

Related parameters	F0.0.09	F0.2.25	F0.3.33	F0.3.35	F0.4.37	F0.4.38	F3.0.01	F3.0.02	F3.0.03
Macro set value	0000	9	1	0	0	0	67	7	8
Value locking	N	Y	Y	Y	Y	Y	Y	Y	Y
Related parameters	F3.0.04	F3.0.05	F3.1.21	F5.3.32	F6.1.15	F6.2.46	F7.0.00	F8.0.00	F8.3.39
Macro set value	13	41	4	1	0	0	0	0	0
Value locking	Y	Y	Y	Y	N	N	N	N	N

F0.0.01 Parameter display and modification (H)	Setting range: 0000~9014	Factory default: 0001
---	---------------------------------	------------------------------

The unit: Parameter display mode:

0: Display all parameters

1: Display effective configuration parameters

To automatically hide the parameters irrelevant with current command or hardware according to different parameter setting commands or different current hardware configuration (e.g. various expansion boards), so as to simplify field commissioning.

2: Display parameters different from factory default

3: Display modified and stored parameters after power-on this time

4: Display modified and un-stored parameters after power-on this time

Tens: Parameter modification mode

The macro parameter **F0.0.00** is also limited by this function.

0: Effective and permanently stored after modification

Parameters modified will be immediately stored in the memory and permanent saved, and will not lose after power-off.

1: Effective after modification but not stored, and getting lost after power-off

Parameters modified are effective but are not saved in the memory. And parameters modified will automatically restore to the values saved in the memory after completion of relevant operation or power-off. This function is used for tentative modification of undetermined parameters for field commissioning; after commissioning, all modified and unsaved parameters can be displayed for view separately (when **the unit** of this parameter is set to **4**), and batch recovery or batch storage will be conducted (when the kilobit of this parameter is set to **2** or **5**).

Hundred: Reserve

Kilobit: Batch recovery or batch storage of parameters

The macro parameter **F0.0.00** is not subject to the influence of this function.

2: Abandon modifying all un-saved parameters (restoring to original value)

All unsaved parameters will be rapidly restored to the values stored in the memory with one key.

This function can only be used when the device is stopped. If this function is activated when the device is running, the inverter will send alarm **aL.058** and give up operation.

5: Batch storing all modified and unsaved parameters

All modified and unsaved parameters will be saved in the memory.

9: resume all parameters to initial values at the last power-on

To restore all parameters to the initial values at the last power-on. Even after initialization, all parameters can be restored to the preliminary power-on values with this function. This function is used to make correction during field commissioning when the system works abnormally because no one knows which parameter is modified incorrectly at the current power-on.

This function can only be used when the device is stopped. If this function is activated when the device is running, the inverter will send alarm **aL.059** and give up operation.

	<p>[F0.0.00] and [F0.0.01] are not limited by the parameter display mode, and will not be concealed in any display mode. The panel displaying parameters concealed due to parameter display mode will not influence the access to the concealed parameter via communication port.</p>
---	---

F0.0.02 Macro-call parameter (system macro) modification password	Setting range: 0~65535	Factory default: 0
--	-------------------------------	---------------------------

For modifying the system macro setting (**kilobit**) of the macro parameter **F0.0.00**, the modification password **1580** must be entered. This password will automatically disappear after **30** seconds. The macro parameter cannot be modified once within **30** seconds upon input of the password. If it is intended to make modification once again, the password should be entered again.

F0.0.03 LCD language selection	Setting range: 0~1	Factory default: 0
---------------------------------------	---------------------------	---------------------------

This parameter is valid when LCD operating panel is configured, and is used to set language of LCD display.

- 0: Chinese**
- 1: English (the reserved option for this series of products)**

F0.0.04 LCD display setting (H)	Setting range: 0000~0037	Factory default: 0023
--	---------------------------------	------------------------------

This function is only effective for the operating panel equipped with LCD.

The unit: Contrast ratio, setting range 0~7.

Tens: Normal display mode

0: Steady mode

1: Single parameter display

The LCD panel will only display the status parameters set for **F0.0.12** in the normal monitoring mode.

2: Dual parameter display

The LCD panel will display the status parameters set for **F0.0.12** and **F0.0.13** in the normal monitoring mode.

3: Three parameter display

The LCD panel will display the status parameters set for **F0.0.12**, **F0.0.13** and **F0.0.14** in the normal monitoring mode.

F0.0.05 Parameter locking (H)	Setting range: 0000–0012	Factory default: 0000
F0.0.06 Parameter locking password	Setting range: 00000–65535	Factory default: 0

After the parameter locking is effective, during modification of the locked parameter, LED panel will display “---”; LCD panel will prompt “password locked and modification forbidden”. This function is used to forbid modification of functional parameters by unauthorized personnel.

The password setting will take effect if **OK** key is pressed down within **30** seconds. If no confirmation (**OK** key) is conducted beyond **30** seconds or any other key is pressed down within **30** seconds, the password setting will be given up. The sketch of locking operation is as below:

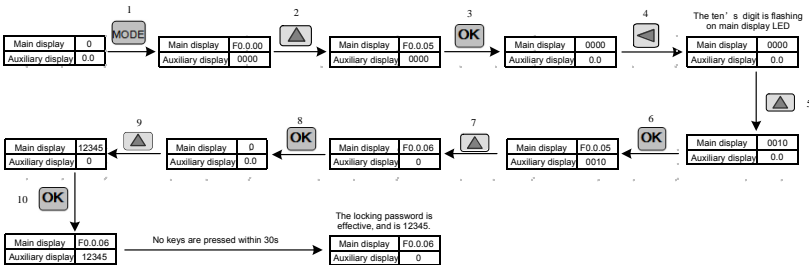

Enter preset password and then press **OK**, and then the parameter locking status will be relieved. The sketch of unlocking operation is as below:

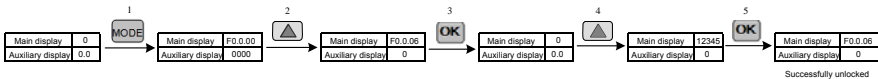

F0.0.08	Parameter copying (H)	Setting range: 0000-0013	Factory default: 0000
----------------	------------------------------	---------------------------------	------------------------------

The unit: Upload and download

0: No action

1: Parameter upload

The inverter will upload parameter values in the control board memory to the panel memory.

2: Parameter download

The parameter values in the panel memory will be downloaded to the control board memory.

3: Parameter download (except for F2 group parameters)

The parameter values in the panel memory will be downloaded to the control board memory (motor parameters will not be downloaded).



Uploading and downloading is forbidden when the inverter is operating, and the settings of this parameter are invalid.

During parameter upload and download, all keys except for **STOP** key on the panel are temporarily locked. Press **STOP** key to forcibly terminate upload and download; when the unload operation is forcibly terminated, the parameters uploaded will be stored in the panel memory, and the parameters not unloaded will be kept unchanged;

When the download operation is forcibly terminated, the inverter will give up all parameters already downloaded into the control board memory, and automatically restore to the values before download.

The alarm signal relevant with this parameter is as below:

aL.071 – Parameter unload failed. Uploaded parameters will be saved in the panel memory, and parameters not uploaded will be kept unchanged.

aL.072 – Uploaded parameter storage failed. The panel memory is damaged or the memory is unavailable.

aL.074 – Parameter download failed. Terminate the parameter download process, and all parameters downloaded will be automatically restored to the values before download.

aL.075 – The board memory parameters are not consistent with the frequency inverter parameters in terms of the version.

aL.076 – There are no effective parameters in the board memory.

aL.077 – Some set values among the panel parameters are out of the allowable range. Terminate the parameter download process, and all parameters downloaded will be automatically restored to the values before download.

F0.0.11 Selection of panel key functions (H)**Setting range: 0000-0224****Factory default: 0000****The unit: Locking of panel keys****0: Not locked**

All keys are effective on the operating panel.

1: All keys except for UP/DW (shuttle), STOP and RUN are locked.

Only UP/DW (shuttle), STOP and RUN keys on the operating panel are effective.

2: All keys except STOP and RUN are locked.

Only the STOP and RUN keys on the operating panel are effective.

3: All keys except STOP are locked.

Only the STOP key on the operating panel is effective.

4: Locking all keys

All keys are void on the operating panel.



When the button locking function is set by this parameter, the locking will not take effective unless ESC button is pressed to back to the normal monitoring mode. See 5.2 Basic Function and Operating Methods of Control Panel for details.

Tens: Function of STOP key**0: The modes other than the panel control are void.**

Only when the running command channel is the operating panel is it effective to press down the STOP key.

1: Press STOP key in any control mode for deceleration stop.

No matter the running command preset channel is the operating panel, external terminals or the communication port, when STOP key is pressed, the inverter will control the motor to achieve deceleration stop according to the current effective deceleration time. The priority of this stop mode is higher than that of parameter F0.4.38.

2: Press STOP key in any control mode for free stop.

No matter the running command preset channel is the operating panel, external terminals or the communication port, when STOP key is pressed, the inverter will stop output, and the motor stop in free sliding mode. The priority of this stop mode is higher than that of parameter F0.4.38.

Hundreds: Function of PANEL/REMOTE keys**0: Void**

The running command channel cannot be switched with PANEL/REMOTE key.

1: Effective at stop

PANEL/REMOTE key is effective at the stop status, but it is void to switch the running command channel with this key when the device is running.

2: Continuous effective

PANEL/REMOTE keys can be used to switch the running command channel both at the stop and running status.

- When the functional setting of **PANEL/REMOTE** keys is effective, and in the normal monitoring mode, the **PANEL/REMOTE** keys can be used to switch the running command channel. The switching status is not saved, and will get lost after power-off. The running command channel for the inverter is still the operating panel after power-on once again.
- If **PANEL/REMOTE** keys are used to circularly switch to desired running command channel, it is required to press “**OK**” key for confirmation within **5 s**. Otherwise, it will not get effective.
- The switching sequence of the running command channel: Operating panel running command channel (**PANEL/REMOTE** light on)→external terminal operating running command channel (**PANEL/REMOTE** light off) → communication port running command channel (**PANEL/REMOTE** light flashing) → operating panel running command channel (**PANEL/REMOTE** light on).



The command channel switching at the running status of the inverter should be used carefully. Be sure the safety before operation. If the running command (FWD/REV/JOG) after switching is inconsistent with that before switching, the inverter will change its current running status (stop, run or REV), which may cause accident.

F0.0.12 Principal monitoring parameter (H)	Setting range: d0.00~d0.55 / d1.00~d1.55	Factory default: d0.00
F0.0.13 Auxiliary monitoring parameter 1 (H)	Setting range: d0.00~d0.55 / d1.00~d1.55	Factory default: d0.02
F0.0.14 Auxiliary monitoring parameter 2 (H)	Setting range: d0.00~d0.55 / d1.00~d1.55	Factory default: d0.04

This group of parameters is used to determine display contents on the operating panel at the status monitoring mode, and bitwise operation must be followed for setting.

Principal monitoring parameter: used to determine display contents on the main display column of the **LED** panel, or the first display parameter on the **LCD** panel (signal parameter display).

Auxiliary monitoring parameter 1: used to determine display contents on the auxiliary display column of the **LED** panel, or the second display parameter on the **LCD** panel (dual parameter display) when the inverter is running.

Auxiliary monitoring parameter 2: is used to determine display contents on the auxiliary display column of the **LED** panel, or the third display parameter on the **LCD** panel (three parameter display) when the inverter is stopped.

The corresponding physical quantity of the display data can be referred to the status monitoring parameter table. When the inverter is conducting detection of motor parameters, the auxiliary display will display the value of the current output current, which is not restricted by the parameter **F0.0.13**.

7.2 Running command selection (Group F0.1)

F0.1.17 Running direction (H)	Setting range: 0000~0021	Factory default: 0000
--------------------------------------	---------------------------------	------------------------------

The unit: Direction switching

0: Void

The running direction is controlled by the direction command.

1: Negate

The running direction is opposite to that directed by the direction command.

Tens: Direction locking

0: Void

The running direction is controlled by the direction command.

1: FWD locking

The motor will run in FWD direction no matter the FWD running command or REV running command is given.

2: REV locking

The motor will run in REV direction no matter the FWD running command or REV running command is given.



- Setting can be down when the inverter is operating. Be sure to confirm that this operation is safe.
- The function of "Direction locking" (tens) has precedence over the function of "direction switching" (the unit).

F0.1.20 Maximum output frequency	Setting range: 10.00~320.00Hz (100.0~1000.0Hz)	Factory default: 60.00
F0.1.21 Upper limiting frequency	Setting range: [F0.1.22]~Min (300.00Hz,[F0.1.20])	Factory default: 50.00
F0.1.22 Lower limiting frequency	Setting range: 0.0Hz-[F0.1.21]	Factory default: 0.0

1. The maximum output frequency is the allowable output maximum frequency of the inverter as set by users (maximum stator synchronous frequency of the asynchronous motor);
2. The upper limiting frequency is the maximum frequency allowed for running of the asynchronous motor as set by users (the maximum frequency corresponding to the mechanical rotor of the asynchronous motor);
3. The maximum output frequency must be higher than the upper limiting frequency;
4. The lower limiting frequency is the minimum frequency allowed for running of the motor as set by users.
5. The maximum output frequency, upper limiting frequency and lower limiting frequency shall carefully set according to the actual nameplate parameters and operating status of the controlled motor and. The relationship among the three is shown in Figure 7-7.

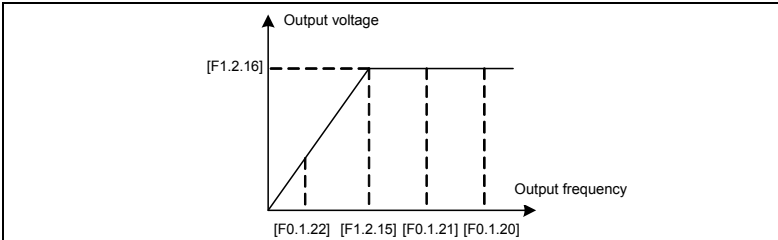

Figure 7-7 Frequency Parameter Definition Sketch



[F1.2.15] in figure 7-7 represents the motor's reference frequency, and [F1.2.16] refers to the motor's reference voltage.

F0.1.23 FWD jog frequency	Setting range: 0.0Hz-[F0.1.21]	Factory default: 10.00
F0.1.24 REV jog frequency	Setting range: 0.0Hz-[F0.1.21]	Factory default: 10.00

Jog running is a special running mode of the inverter. No matter the inverter is initially stopped or running, as long as the jog command is inputted, the inverter will transit to the jog frequency according to the preset jog acceleration and deceleration time. However, it is also influenced by the startup frequency and startup frequency duration as well as the functions of DC band-type braking, startup delay and startup pre-excitation.

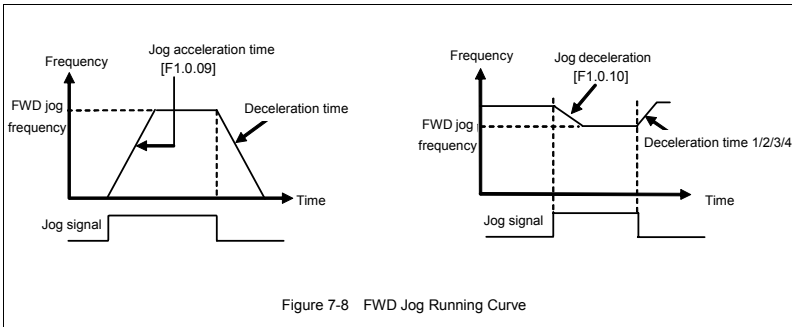

Figure 7-8 FWD Jog Running Curve

7.3 Frequency setup (Group F0.2)

F0.2.25 Frequency setting source	Setting range: 00~29	Factory default: 0
---	-----------------------------	---------------------------

0: Panel digital setting (maintained after stop)

The frequency set value is determined by the value of the parameter **F0.2.29**. In the normal monitoring mode, it is applicable to make direct modification with the \wedge and \vee keys (or shuttle) on the panel. The modified values will not be saved and will get lost after power-on.

1: Panel digital setting (zero clearing after stop)

Similar to the case of "0" as above, the inverter will automatically clear current set value after stop.

2: Panel digital setting (maintained after stop and saved after power-off)

Similar to the case of "0,1" as above, the inverter will automatically save the current set value after power-off, and take the saved value as the initial set value after power-on once again.

3: Setting of panel shuttle potentiometer

Its function is equivalent to the high-precision panel potentiometer. The set resolution is the minimum quantitative value (e.g. **0.01 Hz**), and data are saved in the internal memory of the panel.

4: Terminal UP/DW setting (maintained after stop)

Multifunctional terminals are used to directly increase, decrease (function no. **15, 16**) or clear (function no. **17**) the set frequency. The terminal function is selected by parameters **F3.0.00 ~ F3.0.08**. The set data will not be saved and will get lost after power-off.

The relationship between the status setting combination of the three external switches and the current frequency set value of the inverter is shown in **Figure 7-2**.

Preconditions for below instruction: multifunctional terminal **DI1** frequency or process **PID** setting **UP** function (**[F3.0.00]=15**), **DI2** sets frequency or process **PID DW** function (**[F3.0.03]=16**), and **DI5** sets **UP/DW** with frequency clear function (**[F3.0.04]=17**).

Table 7-2 External Switch Status and Current Frequency

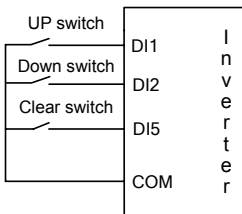

Set Frequency Terminal Status	Maintained	Increased	Decreased	Maintained	Zero
DI1	OFF	ON	OFF	ON	Random
DI2	OFF	OFF	ON	ON	Random
DI5	OFF	OFF	OFF	OFF	ON

Figure 7-9 Terminal UP/DW Wiring Diagram

5: Terminal UP/DW setting (maintained after stop)

Similar to the case of "4" as above, the inverter will automatically clear current set value after stop.

6: Terminal UP/DW setting (maintained after stop and saved after power-off)

Similar to the case of "4" as above, the set value will be saved automatically after power-off, and the initial set data will be the set value at the last power-off when the inverter is powered on once again.

7: Terminal UP/DW two-way setting (maintained in bipolar mode after stop)

The basic operation is similar to that as stated in "4" and the difference is that: in the mode of "4", the set frequency is unsigned values (not containing direction information), and the setting range of the frequency is: 0~upper limiting frequency; while in the mode of "7", the set frequency is signed values (containing direction changing information), and the setting range of the frequency is: - upper limiting frequency upper limiting frequency.

The inverter's actual running direction is according to "XOR" calculation of the command direction (FWD, REV) and the set frequency direction.

8: Terminal UP/DW two-way setting (maintained in bipolar mode after stop and saved after power-off)

The basic operation is similar to the case of "7" as above. The set value will be saved automatically after power-off, and the initial set data will be the set value at the last power-off when the inverter is powered on once again.

9: Analog input AI1

The frequency set value is given via the analog input AI1; for relevant characteristics please see the instructions of the parameters F4.0.00 and F4.0.01.

10: Analog input AI2

The frequency set value is given via the analog input AI2; for relevant characteristics please see the instructions of the parameters F4.0.02 and F4.0.03.

11: Analog input AI3

The frequency set value is given via the analog input AI3; for relevant characteristics please see the instructions of the parameters F4.0.04 and F4.0.05.

12: Given by the analog input AI1 bipolarity

The frequency set value is given by the bipolarity of the analog AI1 ([F4.0.00]~[F4.0.01]), and AI1 contains the direction changing information. For relevant characteristics please see the instructions of the parameters F4.0.00 and F4.0.01.

13: Given by the analog input AI3 bipolarity

The frequency set value is given by the bipolarity of the analog AI3 ([F4.0.04]~[F4.0.05]), and AI3 contains the direction changing information. For relevant characteristics please see the instructions of the parameters F4.0.04 and F4.0.05.

14: Pulse input Fin

The frequency set value is given by the pulse input **Fin**.

15: Given by the pulse input bipolarity

The frequency set value is given by the pulse input **Fin** bipolarity, and the pulse signal contains the direction changing information.

16: MODBUS fieldbus set value 1 (relative set value)

The frequency set value is given by the principal computer through **MODBUS** fieldbus (**RS485** communication port), and the set value (-**10000** ~ **10000**) is relative data and is corresponding to the upper limiting frequency.

17: MODBUS fieldbus set value 2

The frequency set value is given by the principal computer through **MODBUS** fieldbus (**RS485** communication port), and the set value (-**30000** ~ **30000**) is absolute value neglecting the decimal point) (e.g., the value **5000** corresponds to the set frequency **50.00Hz** in general mode, and corresponds to the set frequency **500.0Hz** in the high-frequency macro mode.

18: AI1+AI2

The frequency set value = the frequency value corresponding to the analog input **AI1** + the frequency value corresponding to the analog input **AI2**.

19: AI2+AI3

The frequency set value = the frequency value corresponding to the analog input **AI2** + the frequency value corresponding to the analog input **AI3**

20: AI2+pulse input Fin

The frequency set value = the frequency value corresponding to the analog input **AI2** + the frequency value corresponding to the pulse input **Fin**.

21: AI1*AI2/rail-to-rail input (10V)

The frequency set value = the frequency value corresponding to **AI1** *the frequency value corresponding to **AI2**/the frequency corresponding to the maximum input of **AI2**.

22: AI1/AI2

The frequency set value= the frequency value corresponding to **AI1**/the frequency value corresponding to **AI2**.

23: Process PID output

The frequency set value is given by the process **PID** output. This option is mainly for the system in which the **PID** running output needs to be combined with other setting channel for running. In general running system, this value does not need to be selected. **PID** output will automatically participate in setting competition according to the frequency setting priority.

When this mode is used, the priority (F5.3.28) of command source shall be correctly set, and the **PID** output shall be base on the maximum setting of this channel (F0.2.28) (upper limit frequency shall be

regarded as the reference for those beyond common modes).

24: Compensation PID output (the reserved item of this function for this series of products)

25: Disturbance running frequency

The frequency set value is given by the disturbance running frequency. This option is mainly for the system in which the disturbance running output needs to be combined with other setting channel for running. In general running system, this value does not need to be selected. The disturbance output will automatically participate in setting competition according to the frequency setting priority.

26: Automatic multi-stage running frequency

The frequency set value is given by the multi-stage running frequency. This option is mainly for the system in which the multi-stage running output needs to be combined with other setting channel for running. In general running system, this value does not need to be selected. The multi-stage running output will automatically participate in setting competition according to the frequency setting priority.

Correct setting of priority of command sources ((F5.3.28) is required for afore-said items (item 25 and 26).

27: Terminal selection multi-stage frequency

The frequency set value is determined by the combination status of the four multifunctional input terminals (function no. 1, 2, 3, 4), and the terminal function is set by the parameters **F3.0.00–F3.0.08**. This way allows for multi-stage frequency running.

28: Virtual analog input SA1

29: Virtual analog input SA2

The frequency setting source and set value are determined by the virtual input parameter group F4.4.50 ~ F4.4.54.

7.4 Control command source (Group F0.3)

F0.3.33 Control command	Setting range: 0–2	Factory default: 0
--------------------------------	---------------------------	---------------------------

To select the input physical channel of the inverter control commands (start, stop, forward, reverse, jog and reset, etc).

0: Operating panel

The running control command is given via the operating panel. Please see Chapter 5 for the use of the operating panel.

1: External control terminal

The running control command is given via external control commands, and the terminal function is set by the parameter **F3.0**.

2: MODBUS fieldbus/standard expansion card configuration

The operation command is specified through the expansion communication mode.

F0.3.35 External control terminal action mode (H)	Setting range: 0000-0013	Factory default: 0000
--	---------------------------------	------------------------------

The unit: Control command action mode

Preconditions for below instructions: the multifunctional terminal **DI3** is for **FWD** command function ([F3.0.02]=7), **DI4** is for **REV** function ([F3.0.03]=8), and **DI5** is for three-line running control function ([F3.0.04]=19).

0: Two-line mode 1

1: Two-line mode 2

2: Three-line mode 1

When **K0** is engaged, **FWD** and **REV** control is effective; and when **K0** is unengaged, **FWD** and **REV** control is void, and the inverter will stop.

DI3 terminal ascending edge indicates **FWD** running command

DI4 terminal ascending edge indicates **REV** running command

Three-line mode 2

When **K0** is engaged, **FWD** and **REV**

control is effective; when **K0** is unengaged, **FWD** and **REV** control is void, and the inverter will stop.

DI3 terminal rising edge indicates running command;

DI4 terminal disconnection indicates **FWD** command;

DI4 terminal connection indicates **REV** command.

Control mode	DI4	DI3	Operation command	Figure
Two-line mode 1	OFF	OFF	Stop	
	OFF	ON	FWD	
	ON	OFF	REV	
	ON	ON	Stop	
Two-line mode 2	OFF	OFF	Stop	
	OFF	ON	FWD	
	ON	OFF	Stop	
	ON	ON	REV	

Tens: Control command power-on

initial start mode

Running signal level starting

Running signal rising edge starting (two-line mode 1/2)

The signal given by two-line mode running command is level signal, and when the terminal is at effective status, the inverter will automatically start after power-on. In the system in which power-on auto start is not expected, it is applicable to select the way of rising edge start.

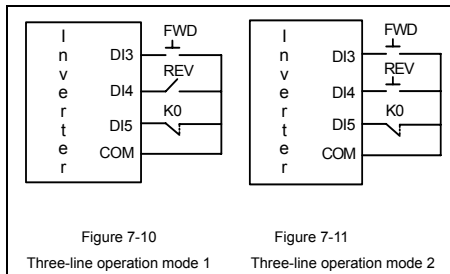

7.5 Start and stop (Group F0.4)

F0.4.37 Start/Running permission (H)	Setting range: 0000~1202	Factory default: 0000
---	---------------------------------	------------------------------

The unit: Start permission

0: Function closed

The inverter can start without start permission signal.

1: Permitted when the multifunctional terminal is effective.

The inverter will not start until it is defined that the multifunctional input terminal (group **F3.0**) of the start permission (function No. **42**) is continuously effective; start is forbidden when it is void, and the inverter which is running will stop freely (alarm code: **aL.031**). The inverter will not start again until the rising edge of the starting signal is detected.

2: Command word from standard fieldbus (standard expansion card)

The start permission signal is from the bus command word.

Hundreds: Running permission

0: Function closed

The inverter can run without running permission signal.

1: Permitted when the multifunctional terminal is effective

The inverter will not start until the multifunctional input terminal (group **F3.0**) which is defined to be running permissible (function no. **43**) is effective; if it is void, the inverter will stop in the way defined by the **kilobit** of this parameter, and will then automatically run again after signal recovery.

2: Command word from standard fieldbus (standard expansion card)

The start permission signal is from the bus command word.

Kilobit: The action mode when the running permission signal is void

0: Free stop

The inverter stops outputting, and the motor stops freely.

1: Deceleration stop

The inverter will stop at deceleration mode according to preset deceleration time.

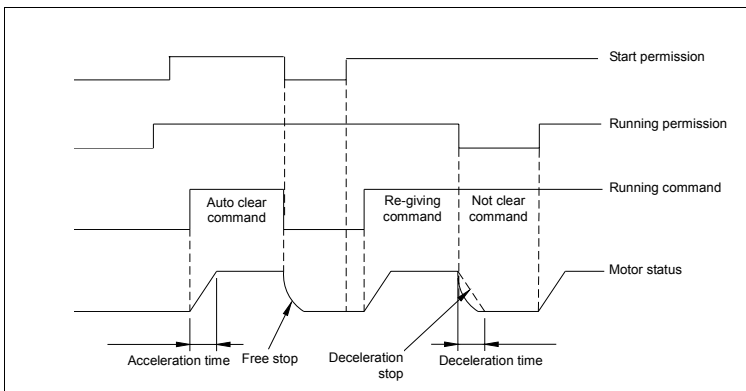

Figure 7-12 Schematic Diagram of Start Process

F0.4.38 Start/Stop Mode (H)	Setting range: 0000-0101	Factory default: 0000
------------------------------------	---------------------------------	------------------------------

The unit: Start mode

0: Normal start

There are no special requirements for most load start mode. Normal start mode will be adopted.

1: Revolution tracking start

It is applicable to the occasion of fault resetting and restart and restart after power-off. The inverter will automatically judge the running speed and direction of the motor, and starts the rotating motor in a smooth and impact-free way according to the detection and judge results; see below figure for the revolution tracking start sketch.

Hundreds: Stop mode

0: Deceleration stop

In the case of deceleration stop, the inverter will gradually reduce the output frequency according to the preset deceleration time until it stops.

1: Free stop

At stop, the inverter outputs zero frequency and clocks output signals, and the motor will stop in a free sliding way according to inertia.

At free stop, if it is needed to restart the motor before the motor stops running completely, it is necessary to appropriately configure the revolution tracking start function; otherwise, it will leads to overcurrent or overvoltage fault protection.

If the motor has not stopped completely in deceleration way, because of high load inertia of the field work and short deceleration time, it is then applicable to start DC band-type braking control. See the instructions of the parameter **F0.4.44** for details.

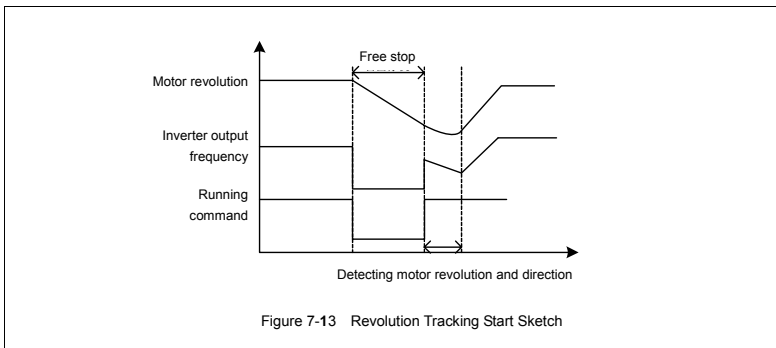

F0.4.39 Start frequency	Setting range: 0.0Hz~50.00Hz	Factory default: 0.50
F0.4.40 Start frequency holding time	Setting range: 0.00~10.00Sec.	Factory default: 0.0

The start frequency means the initial frequency when the inverter starts up, and is not limited by the lower limiting frequency **F0.1.22**.

The start frequency holding time means the duration of operation at the start frequency, and can be set according to actual needs. When it is set to **0**, the start frequency is void.

For the system with high inertia, heavy load and high requirement of start torque, the start frequency can effectively overcome the difficult of start, and the start frequency is also effective in each acceleration process when the inverter switches between forward and reverse running.

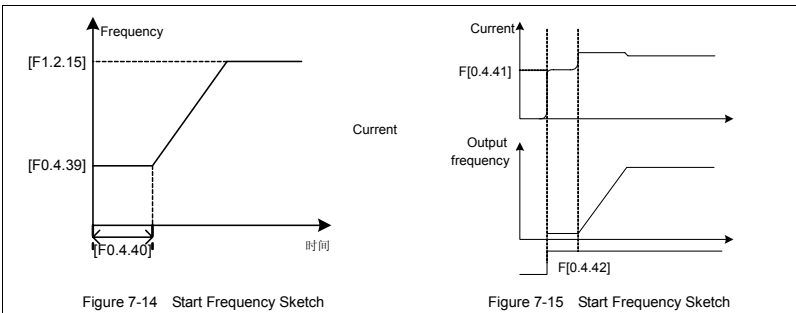

F0.4.41 Start pre-excitation current	Setting range: 0.0~100(%)	Factory default: 35.0
F0.4.42 Start pre-excitation time	Setting range: 0.00~10.00Sec.	Factory default: 0.10

It costs some time to develop air gap flux for asynchronous motor (approaching to the constant of the rotor time). When it is at stop status before the motor is started, in order to get enough start torque, it is a must to develop the air gap flux. Therefore, it is needed to start pre-excitation for the asynchronous motor. See Figure 7-15 for the pre-excitation process.

The set value of start pre-excitation current is the percentage with respect to the inverter rated output current.

The start pre-excitation time means the duration in which the inverter inputs start pre-excitation current for the inverter.



When the rated current of the adapter motor differs greatly from the rated current of the inverter, please carefully set the pre-excitation current (F0.4.41), as excessive setting may damage the motor.

F0.4.43 Start delay	Setting range: 0.00~10.00Sec.	Factory default: 0.0
----------------------------	--------------------------------------	-----------------------------

Start delay means the waiting time before the inverter starts after receiving the running command.

F0.4.44 DC band-type brake control (H)	Setting range: 0000~0001	Factory default: 0000
---	---------------------------------	------------------------------

The unit: DC band-type brake control

The DC band-type brake means to lead DC current into the motor rotor so as to generate braking torque. The DC band-type braking function cannot be used when synchronous motor is driven.

When both the set value and the actual speed of the motor has decreased below [F0.4.45], the inverter will stop generating sine current but will inject direct current to the motor, and the current value is to be set by the parameter [F0.4.47]. When the given speed or the motor speed has surpassed the parameter [F0.4.45], the inverter will stop DC power supply and restore to the normal running status. If it is started, the permission signal will be disconnected, and the DC band-type brake will be void.

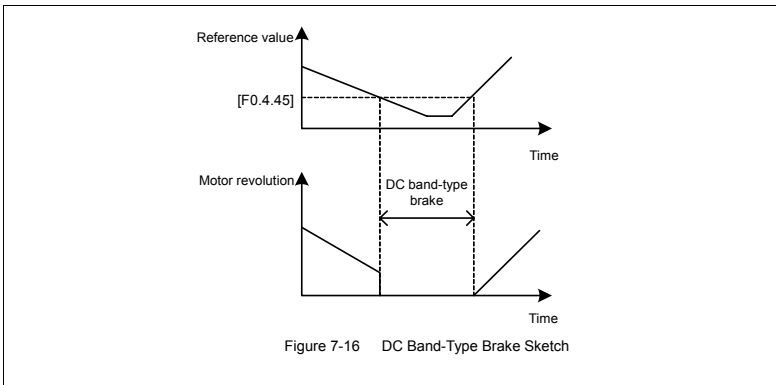

Injecting current to the motor may lead over-temperature of the motor. In the circumstances where long-time DC band-type brake is needed, forced air-cooling motor should be used. During the long time of band-type braking, if there is constant load in the motor band-type brake, DC band-type brake will not guarantee that the motor shaft will not rotate.

F0.4.45 DC band type brake/brake initial frequency/speed	Setting range: 0.0-[F0.1.21]	Factory default: 2.00
---	-------------------------------------	------------------------------

In the deceleration and stop process of the inverter, when the output frequency is lower than the DC band-type brake/brake start frequency/speed, the DC band-type brake/brake function will be started.

F0.4.46 DC brake action time	Setting range: 0.0~10.00Sec.	Factory default: 0.0
F0.4.47 DC band-type brake/brake injection current	Setting range: 0.0~100(%)	Factory default: 50.0

The DC brake time is the duration of the output DC braking current. If it is selected that the external terminal stop DC braking is effective, the parameter of DC braking action time will be void.

The DC band-tape brake/brake injection current means the brake current outputted at the time of inverter DC band-type brake/brake. Its set value is the percentage with respect to the rated current.

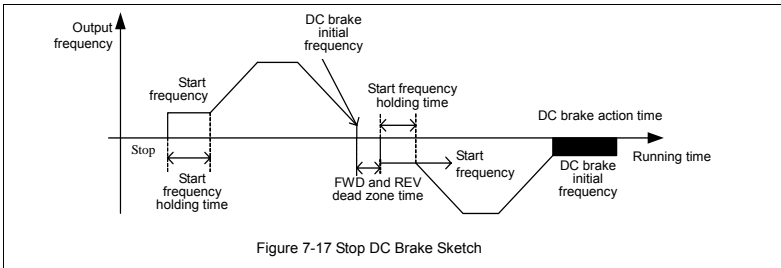

F0.4.48 Restart after power-off	Setting range: 0, 1	Factory default: 0
F0.4.49 Restart after power-off/ restart standby time after power-off	Setting range: 0.10~10.00Sec.	Factory default: 0.5

This is mainly for the trigger start modes of “panel control, bus control and three-line control”. If the power-off restart function is effective, the inverter will automatically save the running command/status before power-off, and will automatically restore to the running status before power-off after the stop restart waiting time when it is powered on again. The power-off restart will restore running in the mode of inspection speed restart.

F0.4.50 Forward and reverse transition dead time	Setting range: 0.00~5.00Sec.	Factory default: 0.0
---	-------------------------------------	-----------------------------

The forward and reverse transition dead time is used to set the waiting time for the motor to shift from FWD to REV or from REV to FWD. This function is used to overcome reversal current compact caused by mechanical dead zone, as shown in Figure 7-18.

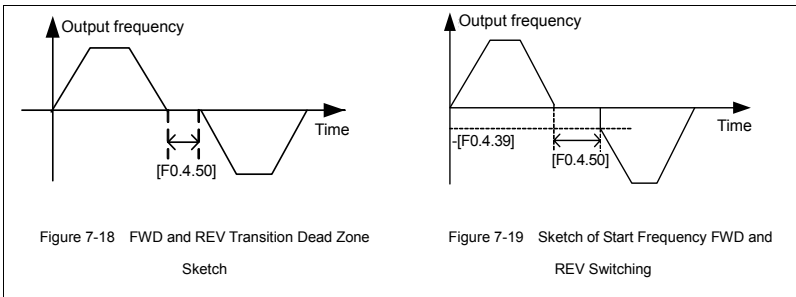

F0.4.51 Forward and reverse switch mode	Setting range: 0, 1	Factory default: 0
--	----------------------------	---------------------------

0: Switch at zero point

To switch between FWD and REV at the zero point.

1: Start frequency switch

To switch between the FWD and REV at the start frequency, as shown in Figure 7-19.

F0.4.52 Zero speed (frequency) detection level	Setting range: 0.0~100.00Hz	Factory default: 0.1Hz
F0.4.53 Zero speed delay time	Setting range: 0.0~10.00Sec.	Factory default: 0.05

When the inverter output frequency is lowered to zero, it will immediately lock the output. At this time, the motor revolution may not at zero, but the motor is completely at the free stop status, and will slide to stop.

Within the delay time, when the inverter output frequency is lower than the zero speed (frequency) detected level [F0.4.52], within the zero speed delay time [F0.4.53], the inverter will keep working and output a DC current, and the motor will keep excitation. The inverter may rapidly restart at any time.

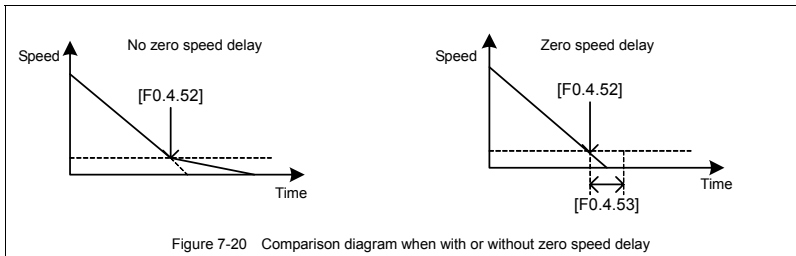

7.6 Acceleration and deceleration characteristics (Group F1.0)

F1.0.00 Acceleration and deceleration characteristics parameters	Setting range: 0000-0011	Factory default: 0000
---	---------------------------------	------------------------------

The unit: Acceleration and deceleration mode

0: Liner acceleration and deceleration

The output frequency of the inverter increases or decreases according to fixed speed. The output frequency has liner relationship with the acceleration and deceleration time, and steadily increases or decreases according to constant gradient.

1: S curve acceleration and deceleration

The output frequency of the inverter increases or decreases according to grading speed, and the characteristics of S curve is determined by the parameter [F1.0.01] and [F F1.0.02]. This function is mainly to reduce noise and ventilation during acceleration and deceleration, and decrease impact of the starting and stop load. When the load inertia is excessive, leading to overload fault during deceleration, it can be improved by adjusting the parameter setting ([F1.0.01] and [F F1.0.02]) of S deceleration curve, so as to reasonably adjust the deceleration rate at different frequency.

Tens: Unit of acceleration and deceleration time

0: Sec. (Second) The acceleration and deceleration time is in the unit of second, and is at factory default value.

1: Min. (Minute) The acceleration and deceleration time is in the unit of minute.

F1.0.01 Time ratio of S curve acceleration starting/deceleration ending period	Setting range: 5.0-100.0-[F1.0.02]	Factory default: 15.0
F1.0.02 Time ratio of S curve acceleration rising/deceleration decreasing period	Setting range: 20.0-100.0-[F1.0.01]	Factory default: 70.0

Define the curve parameters of acceleration and deceleration of S curve.

As shown in item ① in Figure 7-21, the acceleration starting/deceleration ending period of S curve is indicated by the percentage of the total acceleration and decoration time.

As shown in item ② in Figure 7-21, the acceleration rising/deceleration decreasing period of S curve is indicated by the percentage of the total acceleration and decoration time.

F1.0.03~F1.0.08 Acceleration/deceleration time 1/2/3	Setting range: 0.01~600.00 (Sec./Min.)	Factory default: ☆
F1.0.09 Acceleration 4/jog acceleration time	Setting range: 0.01~600.00 (Sec./Min.)	Factory default: ☆
F1.0.10 Deceleration 4/jog deceleration time	Setting range: 0.01~600.00 (Sec./Min.)	Factory default: ☆

The acceleration time means the time required for the inverter to accelerate from **0.00Hz** to maximum output frequency [**F0.1.21**].

The deceleration time means the time required for the inverter to decelerate from the maximum output frequency [**F0.1.21**] to **0.00Hz**.

V320 series inverters are defined with **4** kinds of acceleration/deceleration time. The acceleration/ deceleration time **1~4** during the running process of the inverter can be selected through different combinations of external terminals. During simple PLC running, it is also applicable to use them as the acceleration and deceleration time at the time of switching among different running frequency at each stage. See instructions of **F6.1** group parameters for detail.

The acceleration/deceleration time 4/jog acceleration/deceleration time are also used as the acceleration and deceleration running time at the status of jog running. The jog frequency has the highest priority. At any state, the inverter will immediately transit to the jog frequency running state according to the preset jog acceleration and deceleration time as long as the jog command is inputted. (See the instructions of the functional parameter **F0.1.23** and **F0.1.24**) the unit (sec., min.) of the acceleration and deceleration time is determined by the tens' digit of the parameter **F1.0.00**.

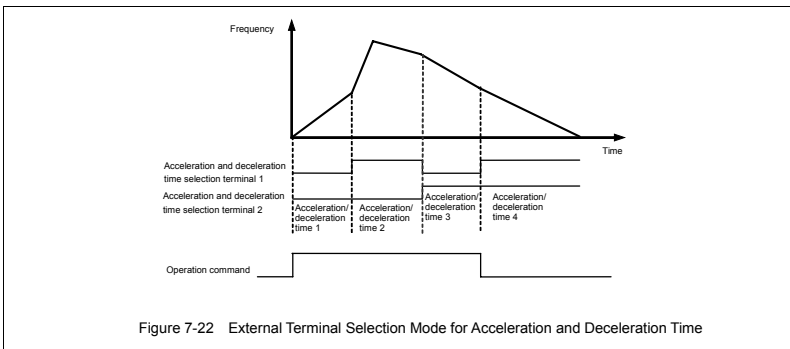

F1.0.11 MS emergency stop and deceleration time	Setting range: 0.01~600.00 (Sec./Min.)	Factory default: ☆
--	---	---------------------------

The time for decelerating from the maximum output frequency [**F0.1.20**] to the zero frequency will only function when the inverter stops in deceleration way (**F0.4.54** is set to **0**) after receiving **EMS** emergency stop command (function no. **14**).

7.7 Carrier frequency (Group F1.1)

F1.1.13 Carrier frequency	Setting range: 1.5~10.0KHz (FF.4.43=##0#) 1.5~12.5KHz (FF.4.43=##1#)	Factory default: ☆
---------------------------	---	---------------------------

It is the switch frequency determining the inverter's internal power module. The allowable maximum carrier frequency is relevant with the inverter model. The carrier frequency mainly influences the audio noise and heat effect during running. When mute running is required, it is applicable to appropriately increase the value of the carrier frequency, but the maximum load allowable for the inverter may be somewhat reduced, accompanied by somewhat increase of interference of the inverter to the outside world. For the circumstances where the motor wire is too long, it may lead to leaking current between motor wires and between the wire and the ground. When the ambient temperature is too high and the motor load is too high, or the inverter is failed due to above reasons, it is suggested to appropriately decrease the carrier frequency to improve thermal characteristics of the inverter.

F1.1.14 Carrier characteristics	Setting range: 0000~2111	Factory default: 2011
---------------------------------	---------------------------------	------------------------------

This parameter is used to set some characteristics relevant with the carrier (binary system setting), and usually needs not be modified.

The unit: Load linkage adjustment

When this function is effective, if the load current is excessive, the carrier frequency will be automatically decreased in order to ensure safe running of the inverter.

Tens: Temperature linkage adjustment

When this function is effective, the inverter will automatically decrease the carrier frequency if the ambient temperature is too high.

Hundreds: Reference frequency linkage adjustment

The inverter will appropriately decrease the carrier frequency if the output frequency is too low.

Kilobit: Modulation mode

0: Asynchronous modulation- It is application to most applications with the output below 300HZ.

1: Synchronous modulation –The carrier frequency and base frequency keep constant ratio, and it is suitable to use this mode in high-frequency operation mode so as to promote high-frequency operation stability.

2-5: Noise smoothing – When this function is effective, the inverter will automatically adjust carrier frequency to smooth audio noise.

7.8 V/F parameters and overload protection (Group F1.2)

F1.2.15 Reference frequency of motor	Setting range: 5.00~300.00Hz 50.0~1000.0Hz	Factory default: 50.00
F1.2.16 Reference voltage of motor	Setting range: 50~500V/25~250V	Factory default: 380/220

The reference frequency means the minimum frequency when the inverter outputs the maximum voltage, and generally is rated frequency of the motor.

The reference voltage means the output voltage when the inverter outputs the reference frequency, and generally is rated voltage of the motor.

This group of parameters is set according to the motor's parameters, and do no need to be modified except for special circumstances.

F1.2.18 Motor torque increasing voltage	Setting range: 0.0~20.0%	Factory default: ☆
--	---------------------------------	---------------------------

It is used to improve the inverter's low frequency torque characteristics. When the inverter runs at low frequency, it will make compensation for the inverter's output voltage. Its set value is the percentage relative to the motor's reference voltage [F1.2.16]. See figure 7-23-A and 7-23-B.

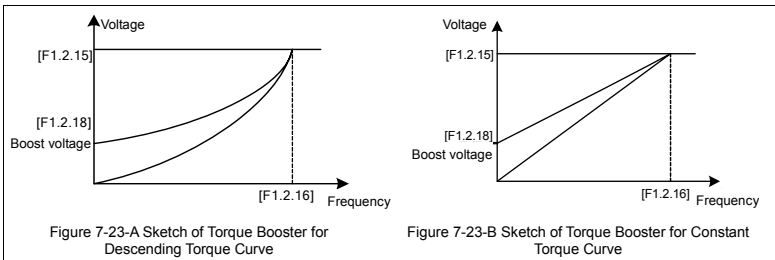

F1.2.19 Frequency point 1 of motor V/F curve	Setting range: 0.0-[F0.1.21]	Factory default: 0.0
F1.2.20 Voltage point 1 of Motor V/F curve	Setting range: 0~500V	Factory default: 0.0
F1.2.21 Frequency point 2 of motor V/F curve	Setting range: 0.0-[F0.1.21]	Factory default: 0.0
F1.2.22 Voltage point 2 of Motor V/F curve	Setting range: 0~500V	Factory default: 0.0
F1.2.23 Frequency point 3 of motor V/F curve	Setting range: 0.0-[F0.1.21]	Factory default: 0.0
F1.2.24 Voltage point 3 of Motor V/F curve	Setting range: 0~500V	Factory default: 0.0

This group of parameters is used to flexibly set V/F curve desired by users, as shown in Figure 7-24.

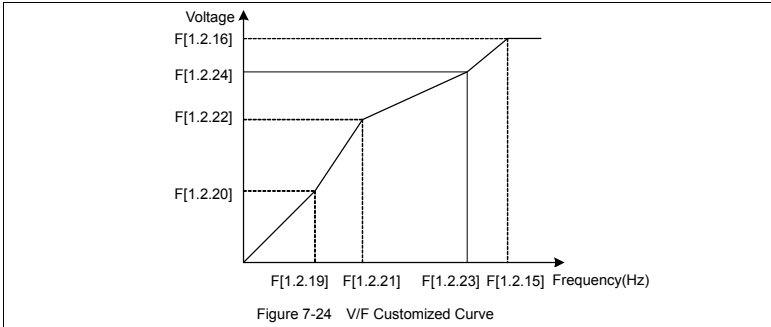

F1.2.25 Motor slip frequency compensation	Setting range: 0~150(%)	Factory default: 0
--	--------------------------------	---------------------------

The actual revolution difference of the motor may vary with the change of the load. Through setting of this parameter, the inverter will automatically adjust the inverter's output frequency according to the load, so as to offset the influence of the load to the motor revolution.

This parameter is only effective to **V/F** control mode.

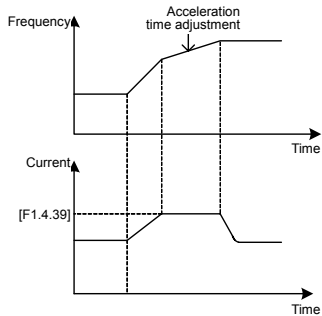
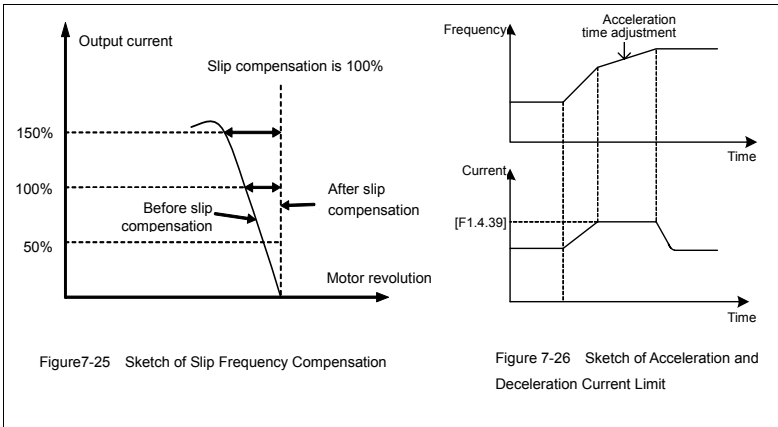

7.9 Steady running (Group F1.4)

F1.4.39 Acceleration/deceleration current limiting level	Setting range: 120~180 (%)	Factory default: 150 (%)
---	-----------------------------------	---------------------------------

When the frequency inverter is in acceleration and deceleration running, for the acceleration and deceleration time does not match to the motor inertia or load breaks, there can be phenomenon of steep current rise. This parameter is used for setting the allowed output level when frequency inverter is in state of acceleration. Setting value is the relevant percentage of rated output current of frequency inverter.

When the output current of frequency inverter exceeds the specified level of this parameter, acceleration and deceleration time will be automatically delayed, to ensure the output current limited within the range of this level, refer to the figure 7-26. Thus, for occasions requiring shorter acceleration time, acceleration torque level shall be properly improved.

F1.4.40 Strong start current limiting level	Setting range: 120~200 (%)	Factory default: 150(%)
F1.4.41 Strong start current holding time	Setting range: 0.00~5.00Sec.	Factory default: 0.0

Function is similar with [F1.4.39], limit the current value when frequency inverter is in acceleration and starting. For some systems with large inertia, or requires to overcome great static friction at start, large starting current can be set for a certain time ([F1.4.41]), to meet the requirement. Setting value is the relevant percentage of rated output current of frequency inverter.



When F1.4.41 is set as zero, it means the function of current limit of strong start is closed.

F1.4.42 Function selection for adjustors	Setting range: 0000~0112	Factory default: 0111
---	---------------------------------	------------------------------

The unit: Overvoltage suppression adjustor

When setting is valid, for load with energy feedback, in order to suppress overvoltage, frequency inverter may lift output frequency automatically, making it exceed selected frequency (limited by upper limiting frequency). Be attention if it is dangerous to the equipment safety when setting.

Tens: Undervoltage suppression adjustor

When setting is valid, undervoltage caused by sudden fall of grid voltage, frequency inverter may lower output frequency automatically, accessing into feedback braking state, to keep running with mechanical energy for a certain time to ensure the normal running of equipment.

Hundreds: Frequency modulation and current

When setting is valid, if the output current exceeds the maximum current [F1.4.47], frequency inverter will lower output frequency automatically.

Thousand: Fault self recovery mode;

when setting is valid, it will start in normal way after fault self recovery;when setting is invalid it will

start in speed tracking mode.

F1.4.43	Action level of the overvoltage adjustor	Setting range: 660~800V	Factory default: 740
F1.4.44	Overvoltage adjusting gain	Setting range: 0.10~10.00	Factory default: 1.00

When the motor is dragging overvoltage or in process of deceleration stop with large inertia, it may access into recycle braking state, causing rapid rise of direct current bus voltage of frequency inverter, leading to overvoltage protection action. When frequency inverter detects the direct current bus voltage exceeds [F1.4.43], it will adjust output frequency (extended deceleration time or increase frequency), to ensure continually safe running.

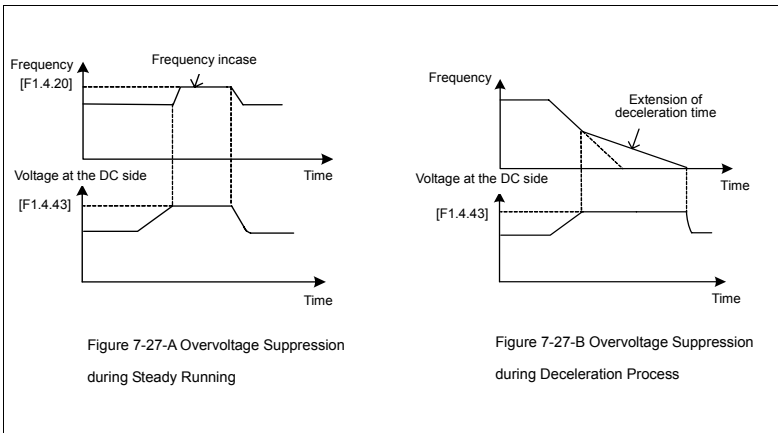

The larger the overvoltage adjusting gain is, the more obvious the suppression is, but it may lead to unsteady running.

F1.4.45	Action level of the undervoltage adjustor	Setting range: [FF.2.35]~480V	Factory default: 400V
F1.4.46	Undervoltage adjusting gain	Setting range: 0.10~10.00	Factory default: 1.00

When frequency inverter detects the direct current bus voltage is below [F1.4.45], it may lower output frequency automatically, accessing into recycle braking state, keep running with mechanical energy. The larger the undervoltage adjusting gain is, the stronger undervoltage suppression is.

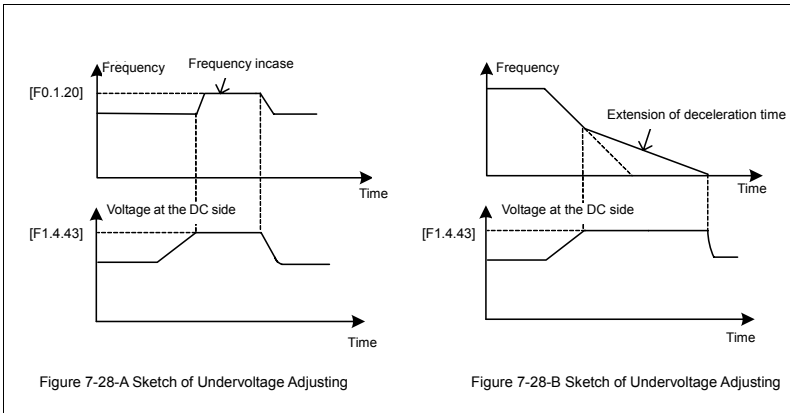

F1.4.47 Action level of current limiting adjustor	Setting range: 20~200(%)	Factory default: 180
F1.4.48 Adjusting gain of the current limiting adjustor	Setting range: 0.10~10.00	Factory default: 1.00

When the output current of frequency inverter exceeds [F1.4.47], it may lower output frequency automatically to suppress current from further increasing, to ensure continually safe running. The bigger (F1.4.48) gain is, the stronger current suppression is. Setting value is relevant percentage of rated output current of frequency inverter.

F1.4.49 Recovery times of fault self resetting	Setting range: 0~5	Factory default: 0
F1.4.50 The recovery waiting time of fault self resetting	Setting range: 0.2~100.0Sec	Factory default: 1.0
F1.4.51 Time period for self resetting timing	Setting range: 900~36000Sec	Factory default: 3600

Fault self resetting refers to that when the frequency inverter breaks down, with a period of time, fault self resetting can be operated and recover to run with starting way of speed inspection. When accumulated resetting times exceeds setting value [F1.4.49], self resetting action terminates. When self resetting time [F1.4.49] is set as zero, it means this function is banned.

Recovery waiting time of fault self resetting gets longer with resetting times: waiting time=[F1.4.50] * already reset times.

Each time it passes the set parameter period [F1.4.51], or external forced fault reset, it will automatically eliminate one self resetting record.

F1.4.52 Self-restoration fault selection	Setting range: 0000~1111	Factory default: 0.000
The Unit: overcurrent	0: self-resetting forbidden	1: Self-resetting permitted
Tens: overvoltage	0: self-resetting forbidden	1: self-resetting permitted
Hundreds: Output earthing	0: self-resetting forbidden	1: self-resetting permitted
Kilobit: Operation undervoltage	0: self-resetting forbidden	1: self-resetting permitted

F1.4.53 Display coefficient	Setting range: 0.001~60.000	Factory default: 1.000
------------------------------------	------------------------------------	-------------------------------

It is used to monitor display correction of parameters d0.0.00, d0.0.01, d0.0.9 and d0.0.10. Displayed value = actual value × [F1.4.53].

7.10 Motor parameters (Group F2.0)

F2.0.00~F2.0.04 Motor rated parameters	— —	Factory default: ☆
---	------------	---------------------------

Nameplate parameters of asynchronous motor, for ensuring g performance control, make sure that:

- 1) Correctly set nameplate parameters;
- 2) Power level of motor and frequency inverter shall be match with each other; generally motor only can be two levels less or one level more than frequency inverter.

After the rated power setting (F2.0.00) is changed, following parameters (F2.0.00 ~ F2.0.09) will then automatically matched and modified. Please conduct setting according to the sequence.

When any one of the nameplate parameters is changed, the frequency inverter will automatically set static identification of motor parameters once. With the motor is connected for operation for the first time, it will automatically conduct one time of parameter static identification (parameter FF.4.43 can shield this function).

F2.0.10 Slip compensation coefficient	Setting range: 0.50~1.50	Factory default: 1.00
--	---------------------------------	------------------------------

Slip compensation coefficient is used for slip frequency calculation, valid with vector control mode. With SVC running, this parameter can be amended to adjust speed for compensation control

F2.0.24 Z pulse initial angle	Setting range: 0.0~359.9	Factory default: 0.0
--------------------------------------	---------------------------------	-----------------------------

This parameter is valid when Z pulse selection is valid ([F8.0.07] = 1), used for set corresponding mechanical rotating angle of Z pulse position.

F2.0.25 Motor overload protection coefficient	Setting range: 50.0~131.0%	Factory default: 110.0
--	-----------------------------------	-------------------------------

This parameter is used for setting sensitivity of heat relay protection to load motor of frequency inverter. When the rated current of the load motor does not match with the rated current of the inverter, correct thermal protection can be secured by setting this value.

The set value of this parameter can be confirmed through below formula:

$$[F2.0.25]=\text{motor rated current / inverter rated current} \times 100\%.$$

When fixed value of this parameter is **131.0%**, overload protection function of motor closes.



When one frequency inverter runs with several motors in parallel, function of heat relay protection of frequency inverter will be out of action automatically. In order to protect motor efficiently, it is suggested that installation of heat protection relay in each motor.

7.11 Parameter measurement and pre-excitation (Group F2.2)

F2.2.52 Start pre-excitation time in vector mode	Setting range: 0.02~2.50Sec.	Factory default: ☆
---	-------------------------------------	---------------------------

This parameter is valid with vector operation; the pre-excitation action must be conducted prior to start of motor, to build air gap flux to obtain enough starting torque. This excitation process shall be conducted after action defined of parameter **F0.4.42**, excitation current shall be calculated automatically as selected time. The shorter the excitation time is, the larger the current is.

F2.2.53 Motor parameter measurement	Setting range: 0, 1, 2	Factory default: 0
--	-------------------------------	---------------------------

Motor parameter measurement function must be started when vector control mode is selected (tens of **F0.0.09** is set as **0** or **1**).

When this function (when **F2.2.53** is set as **1** or **2**) is enabled, parameter identification operation will be carried when the frequency inverter is start. After parameter identification is over, **F2.2.53** will be automatically reset. Obtained motor parameters will be stored in internal memory of the frequency inverter, and value of parameter F2.0.05 ~ F2.0.09 will be automatically updated.

Before identification operation, please confirm that:

- 1) Nameplate parameter of motor (**F2.0.01~F2.0.04**) has been input correctly;
- 2) The motor is in stopped condition.

0: Closed

1: Static identification

During parameter setting, the motor will be always kept in stop status (idling motor may be subject to slight offset of axis angle).

2: Static + operating identification

Frequency inverter will conduct static identification at first, and then automatically start operation identification process. During operation identification process, stop order can be input to forcedly terminate identification process. At that time, the identification request is not cleared out, so when restarted, identification process will be enabled again.

Top operating frequency of operation identification will reach 80% of rated frequency of motor. Before

identification starts, please be sure to confirm the equipment safety, and it will automatically stop operating when identification ends.



During the process of operation identification of motor parameter, it is a must that there is no load of motor during the whole process; otherwise, incorrect motor parameters will be obtained.

7.12 Multifunctional input terminal (Group F3.0)

F3.0.00~F3.0.05 Multifunctional input terminals DI1~DI6	Setting range: 0~96	—
F3.0.06 Multifunctional input terminal DI7/ standard expansion card	Setting range: 0~96	Factory default: 0
F3.0.07 Multifunctional input terminal DI8/ standard expansion card	Setting range: 0~96	Factory default: 0
F3.0.08 Multifunctional input terminal DI9/Fin/ standard expansion card	Setting range: 0~98	Factory default: 97

Control terminals **DI1~DI9/Fin** are functional programmable switch input terminals; they can define the DI1~DI9/Fin functions respectively by way of the setup of **F3.0.00~F3.0.08** values; See their set values and relevant functions in Exhibit 1 (Comparison Table of Multifunctional Terminals (DI/EDI/SDI) Function).

For example: Define F3.0.00 as 23, so the function of DI1 can be defined as "Simple PLC Multistage Operation Input"; when the DI1 terminal status validates, simple PLC multi-stage operation input function can be realized.

The function specifications in the table as following:

1~4: Multi-speed control terminals 1~4

By means of the **ON/OFF** status combinations of these four functional terminals, select the set frequencies relevant to **F6.0.00~F6.0.15** parameters as the current set frequencies of frequency converter.

Table 7-3 Multi-speed operation selection table

Multi-speed control 4	Multi-speed control 3	Multi-speed control 2	Multi-speed control 1	Frequency set
OFF	OFF	OFF	OFF	Ordinary operation frequency (F0.1.16 determined)
OFF	OFF	OFF	ON	Multi-stage operation frequency 1
OFF	OFF	ON	OFF	Multi-stage operation frequency 2
OFF	OFF	ON	ON	Multi-stage operation frequency 3
OFF	ON	OFF	OFF	Multi-stage operation frequency 4

Multi-speed control 4	Multi-speed control 3	Multi-speed control 2	Multi-speed control 1	Frequency set
OFF	ON	OFF	ON	Multi-stage operation frequency 5
OFF	ON	ON	OFF	Multi-stage operation frequency 6
OFF	ON	ON	ON	Multi-stage operation frequency7
ON	OFF	OFF	OFF	Multi-stage operation frequency 8
ON	OFF	OFF	ON	Multi-stage operation frequency 9
ON	OFF	ON	OFF	Multi-stage operation frequency10
ON	OFF	ON	ON	Multi-stage operation frequency 11
ON	ON	OFF	OFF	Multi-stage operation frequency 12
ON	ON	OFF	ON	Multi-stage operation frequency 13
ON	ON	ON	OFF	Multi-stage operation frequency 14
ON	ON	ON	ON	Multi-stage operation frequency 15

5-6: External forward/Reverse jog control

Used for jog operation control under the external terminal control mode (regard F0.3.33/F0.3.34 as 1).

7-8: Forward (FWD)/Reverse (REV) running command terminal

The forward (FWD)/reverse (REV) running control applied under the external terminal control mode(regard **F0.3.33** as 1); according to the setup of **F0.3.35**, it can jog two-line mode and three-line mode (regard another external control terminal as three-line running command function (Function No. 19)).

9-10: Acceleration and deceleration time 1 and 2

By means of the acceleration and deceleration time, selecting the **ON/OFF** status combinations of terminals can realize the selection of acceleration and deceleration time 1~4 (refer to parameter specifications of **F1.0.03~F1.0.10**). If the user doesn't define this function, frequency inverter can automatically select acceleration and deceleration 1, except simple **PLC** jog. See the acceleration and deceleration time selection as following table.

Table 7-4 Contrast table of acceleration and deceleration time selection

Acceleration and deceleration time selection 2	Acceleration and deceleration time selection 1	Acceleration and deceleration time
OFF	OFF	Acceleration time 1/Deceleration time 1
OFF	ON	Acceleration time 2/Deceleration time 2
ON	OFF	Acceleration time 3/Deceleration time 3
ON	ON	Acceleration time 4/Deceleration time 4

11: Running command switching

This function is applied to switch running command of frequency inverter between control command 1 and control command 2. See the running command switching status as following table:

Table 7-5 Contrast table of jog command switching

Terminal status	Running command of frequency inverter
ON	Running command 2
OFF	Running command 1

12: Frequency command switching

This function is applied to switch frequency setting source of frequency inverter between frequency setting source 1 and frequency setting source 2. See the frequency command switching status as following table:

Table 7-6 Contrast table of frequency command switching

Terminal status	Frequency setting source of frequency inverter
ON	Frequency setting source 2
OFF	Frequency setting source 1

13: Fault resetting input (RESET)

When fault alarm occurs to the frequency inverter, resetting can be done through external terminals, and the input rising edge is valid; the function is coincident to the function of the **STOP/RESET** button on the operating panel.

14: Emergency stop (EMS)

Whatever status frequency inverter operates, if the functional terminal is effective, frequency inverter stops in terms of set emergency stop mode (F0.4.54) and starts to operate with rising edge of running command.

15~16: Frequency or Process PID set value ascending (UP)/descending (DW)

V320 frequency inverter can achieve the setup of operation frequency via external terminal and long-distance frequency set operation. If the terminal is effective, set frequency increases progressively or decreases progressively in the light of set speed; if the terminal is ineffective, set frequency keeps same. If both terminals are effective, set frequencies keep same. See 4~8 parameter functional specifications of F0.2.25.

17: UP/DW set frequency zero clearing

Set frequency of external terminal can be cleared to zero through the functional terminal (set frequencies of frequency increasing progressively command UP/decreasing progressively command DW). The function invalidates frequencies set by other frequencies setting modes.

18: External equipment fault

Inputting external equipment fault signal through the terminal is easy for frequency inverter to fault supervision and communication to external equipment. Since frequency converter receives external equipment fault, displaying "Fu.017" indicates the external equipment fault, and the inverter will make a stop forcefully.

19: Three-line running control

When select the three-line running mode under the external terminal control (regard F0.3.33/ F0.3.34 as 1), define three-line running control for input terminal. See Three-line Mode Introduction (regard F0.3.35 as 2 or 3).

20: Stop DC braking command

When frequency inverter is in the process of deceleration stop and running frequency is lower than the straight flow brake or brake starting frequency or speed, the function is effective. When the terminal status is effective, execute DC brake; only when the terminal status is ineffective, DC brake can be stopped. When operate this function, DC braking functional time

F0.4.46 is ineffective.

21: Acceleration and deceleration forbidden

When the terminal is effective, suspend acceleration and deceleration forbidden and frequency inverter keeps current frequency operation as the acceleration and deceleration achieves; if the terminal is ineffective, execute ordinary acceleration and deceleration command.

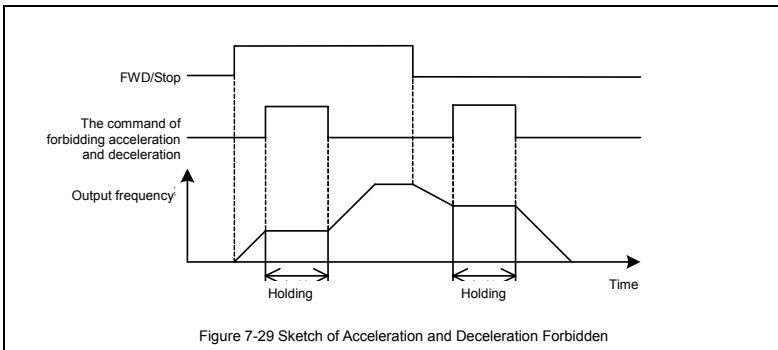
**22: Process PID effective**

When selecting the multifunctional input terminals in the process **PID**, the function can achieve process **PID**'s input and cutting off.

23: Simple PLC multi-stage running effective

When select the multi-stage frequencies or rotation condition input in the programmable multi-stage speed operation mode (regard F6.1.15 as ###2), the functional terminal can achieve simple PLC multi-stage running's input and cutting off.

24: Swing frequency running effective

If swing frequency running is valid of terminal (set **F6.2.46** as ###2), the functional terminal can input and cut off swing frequency running. If terminal status is effective, frequency converter runs swing frequency. If terminal status is ineffective, frequency inverter can accelerate and decelerate into swing frequency preset frequency [F6.2.47] for running according to effective acceleration and deceleration time (set acquiescent value to acceleration and deceleration time 1).

25: Reserve

26: Simple PLC multi-stage running status (when stopping) resetting

Simple PLC multi-stage running status at stop status can be selected to be automatically memorized ([F6.1.15] = #1##/#2##). The functional terminal can allow for forceful restoration to the status of being automatically memorized.

27: Swing frequency status resetting (effective when stopping)

If the swing frequency's current running status selects ([F6.2.46] = ##0#) swing frequency operation when automatic memory stop, the functional terminal can reset the status of swing frequency forcefully.

28-30: Process PID multi-stage given terminals 1~3

Using status combinations of ON/OFF of multi-stage process PID given terminals 1~3 can achieve selection of multi-stage process PID given terminals as following table.

Table 7-7 Contrast table of multi-stage process PID given terminals selection

Multi-stage process PID given terminal 3	Multi-stage process PID given terminal 2	Multi-stage process PID given terminal 1	Process PID multi-stage given selection
OFF	OFF	OFF	Ordinary process PID given (determined by F7.0.01)
OFF	OFF	ON	Process PID multi-stage given 1
OFF	ON	OFF	Process PID multi-stage given 2
OFF	ON	ON	Process PID multi-stage given 3
ON	OFF	OFF	Process PID multi-stage given 4
ON	OFF	ON	Process PID multi-stage given 5
ON	ON	OFF	Process PID multi-stage given 6
ON	ON	ON	Process PID multi-stage given 7

31: Process PID setting selection (switching)

The functional terminal is applied to switch process **PID** setting of frequency inverter between process **PID** setting 1 and process **PID** setting 2. See process **PID** setting switching status as following table:

Table 7-8 Contrast table of switching status of process PID setting

Terminal status	Process PID setting of frequency inverter
ON	Process PID setting 2
OFF	Process PID setting 1

32: Process PID feedback selection (switching)

This functional terminal is applied to switch Process **PID** feedback of frequency inverter between process **PID** setting 1 and process **PID** setting 2. See switching status of process **PID** as following table:

Table 7-9 Contrast table of switching status of process PID feedback

Terminal status	Process PID feedback of frequency inverter
ON	Process PID feedback 2
OFF	Process PID feedback 1

33: Process PID sleep activation

When the sleep function is activated by multifunctional input terminals (set **F7.2.34** as 2), the functional terminal can activate process **PID** sleep function.

34: Torque/speed control mode switching

The functional terminal is applied to switch closed loop control mode of frequency inverter between torque control and speed control. See the closed loop control mode of frequency inverter as following table:

Table 7-10 contrast table of closed loop control mode of frequency inverter

Terminal status	Closed loop control mode of frequency inverter
ON	Speed control mode
OFF	Torque control mode

35: Select minimum torque limit setting value

This function is applied to switch minimum torque limit setting value of frequency inverter (negative torque limit) between minimum torque limit 1 and minimum torque limit 2. See switching status as following table:

Table 7-11 Minimum torque limiting selection contrast table of frequency inverter

Terminal status	Minimum torque limit set value of frequency inverter
ON	Minimum torque limit 2
OFF	Minimum torque limit 1

36: Selection of maximum torque limit setting value

This function is applied to switch maximum torque limit setting value of frequency inverter between maximum torque limit 1 and maximum torque limit 2. See switching status as following table:

Table 7-12 Maximum torque limit selection contrast table of frequency inverter

Terminal status	Maximum torque limit setting value
ON	Maximum torque limit 2
OFF	Maximum torque limit 1

37: Reserved**38: Load dynamic balance effective****39: Communication linkage setting effective**

During communication linkage control, the linkage setting of (effective) slave machine can be separately removed. Then other setting channel can be automatically selected according to the priority setting.

40: RS485 external/Standard operation panel switching

When two operation panels are inserted to frequency inverter at the same time, one is for master control panel switching, and the other is for monitoring only, and the order cannot be inputted in.

Table 7-13 Control command channel switching and selecting table for frequency inverter

Terminal state	Control command channel of frequency inverter
ON	RS485 external panel
OFF	Standard operation panel

42: Start permission

When parameter **F0.4.37** is set to **###1** or **###2**, the function terminal is valid.

43: Running permission

When parameter **F0.4.37** is set to **#1##** or **#2##**, the function terminal is valid.

44~45: Counter clock terminal

This terminal is used for inputting resetting signal of counter.

46~47: Counter trigger signal

This terminal is used as counter trigger end.

48~49: Counter resetting terminal

This terminal is used for inputting resetting signal of counter.

50~51: Counter auto control signal

This terminal is used for inputting gating signal of counter.

52~54: Timer trigger signal

This terminal is used as timer trigger end.

55~57: Timer resetting

This terminal is used for inputting resetting signal of timer.

58~60: Timer gated signal

This terminal is used for inputting gating signal of timer.

61: Single pulse accumulative length value resetting

This terminal is used for resetting of single pulse accumulative length counting value.

62~64: Reserved parameters

65: Input magnetic flux brake

It is applied to input and removal of magnetic flux brake during the deceleration halt process.

66: Position pulse counting resetting

The inverter contains a 32-bit PG encoder pulse accumulative /regressive device, which is used to display the current position of the transmission shaft (PG mounting shaft) (monitoring parameter d1.2.18~19). This function is used for value clearing of pulse accumulative/regressive device.

67: Automatic shifting

This function is especially used for transmission machineries with mechanical shifting function (e.g. machine tool drive). When it is effective, the inverter will drive motor to rotate forward or reversely at low speed, so as to facilitate smooth shifting and avoid mechanical lock.

68~96: Reserved

97: Pulse input port (0.10 ~ 100.00 KHz)

This function is applied to multi-function input terminal **D19/Fin (F3.0.08)**, and signal of 0.10~100.00 KHz can be received effectively.

98: Pulse input port (1.0 ~ 1000.0Hz)

This function is applied to multi-function input terminal **D19/Fin (F3.0.08)** and low frequency signal of 1.0~1000.0Hz can be received effectively.

F3.0.09 Multifunctional terminal filtering time (D11~D15)	Setting range: 1~50ms	Factory default: 5 ms
F3.0.10 Multifunctional terminal filtering time (D16~D19) / standard expansion card	Setting range: 1~50ms	Factory default: 5 ms

Set the filtering time of the input terminal detection. When state of the input terminal changes, while after the setting filter time setting it remains the same, the change of terminal state is effective, otherwise it will remains the former state, thus the interference triggered by false operation can be reduced.

F3.0.11 Input terminal effective level (H)**Setting range: 0000~01FF****Factory default: 0000**

Define the positive and negative logic of the input terminal.

Bit place as **0** represents the positive logic; Positive logic: When **Dlx** terminal and common port **COM** are connected, it is valid, or otherwise it is invalid.

Bit place as **1** represents negative logic; Negative logic: When **Dlx** terminal and common port **COM** are disconnected, it is valid, or otherwise it is invalid.

Determine methods of parameter setting value, please refer to the following table:

Table 7-15 Correspondence between Binary Number Setting and Digital Show Value

Binary number setting				Hexadecimal (digital show value)
BIT3	BIT2	BIT1	BIT0	
0	0	0	0	0
0	0	0	1	1
0	0	1	0	2
0	0	1	1	3
0	1	0	0	4
0	1	0	1	5
0	1	1	0	6
0	1	1	1	7
1	0	0	0	8
1	0	0	1	9
1	0	1	0	A
1	0	1	1	b
1	1	0	0	C
1	1	0	1	d
1	1	1	0	E
1	1	1	1	F

7.13 Multifunctional output terminal (Group F3.1)

F3.1.12 Multifunctional output terminal DO1	Setting range: 0~71	Factory default: 1
F3.1.13 Multifunctional output terminal DO2	Setting range: 0~71	Factory default: 2
F3.1.14 Multifunctional output terminal DO3/ Fout/ expansion function	Setting range: 0~71	Factory default: 63
F3.1.21 Multifunctional relay output (RO1A/B/C)	Setting range: 0~71	Factory default: 4
F3.1.22 Multifunctional relay output (RO2A/B/C) expansion card	Setting range: 0~71	Factory default: 5

The control terminal **D01-D03** is the on-off output terminal with programmable function, and its functions can be defined by set values of **F3.1.12-F3.1.14**; output **R01** and **R02** of relay is on-off output terminal with programmable function, which can be defined by set values of **F3.1.21** and **F3.1.22**. Please refer to the attached list for their setting values and corresponding functions (Reference table of variables of multi-function output terminal (DO/EDO/SDO)).

1: Inverter running ready

When inverter is in normal running ready state, terminal will output effective signal/relay will pick up (connection of **TA** and **TC**).

2: Inverter is running

When the inverter is in running state, terminal will output effective signal/relay will pick up.

3: Equipment normal

When inverter is fault free, and DC busbar voltage is normal, terminal will effectively indicate signal/relay will pick up.

4: Equipment fault

When inverter goes wrong and sends fault signal, terminal will output effective signal/relay will pick up.

5: Equipment alarm

When there is exception of inverter and sending warning signal, terminal will output effective signal/relay will pick up.

6: Equipment fault or alarm

When there is fault for exception of inverter and sending fault or warning signal, terminal will output effective signal/relay will pick up.

7: Reverse running

When electric motor rotates reversely, the terminal will output the valid signal/relay will pick up.

8: Valid running command

When running instruction of inverter is valid, the terminal will output the valid signal/relay will operate.

9: Running at zero speed

When running instruction is valid but output frequency of inverter is at zero and there is current output, terminal will output effective signal/relay will pick up.

10: Speed not at zero

When the speed of rotator of electric motor is not at zero (**VC** mode) or output frequency is not at zero (**VF** or **SVC** mode), terminal will output the valid signal/relay will pick up.

11: Inverter undervoltage stop

When inverter is in under-voltage stop and reporting **Fu.008**, the terminal will output the valid signal/relay will pick up.

12: Valid external control

When control command of frequency converter is given not on panel, terminal will output the valid signal/relay will pick up.

14: Running at power generating status (braking)

When inverter is in regenerative braking running state, terminal will output the valid signal/relay will pick up.

19: Completion of current stage of multi-stage running (0.5s pulse)

After completion of current stage of multi-stage running, terminal will output the valid pulse signal with **0.5S** width/relay will disconnect after pick-up for **0.5S**.

20: Multi-stage running completed (0.5S pulse)

After completion of one cycle of multi-stage speed running, terminal will output the valid impulse signal with **0.5S** width/relay will disconnect after pick-up for **0.5S**.

21: Multi-stage running completed (continuous level output)

After completion of one cycle of multi-stage speed running, terminal will output continuous valid signal/relay will pick up.

22: Multi-stage running cycle completed (0.5Spulse)

After completion of one cycle of multi-stage speed running, terminal will output effective impulse signal with **0.5S** width/relay will disconnect after pick-up for **0.5S**.

23: Swing frequency upper and lower limit

After selection of wobulation, if the frequency fluctuation range of wobulation, which calculated based on center frequency, is above upper limit frequency **F0.1.21** or below lower limit frequency **F0.1.22**, then terminal will output effective signal/relay will pick up.

24: Encoder direction

It is used to indicate the directional signal output by current encoder frequency division.

26/29/32: Monitoring parameters 1/2/3 below the lower limit

When monitoring parameters **1/2/3** are below the lower limit values, terminal will output the valid signal/relay will pick up, which keeps until monitoring parameters **1/2/3** are above the upper limit values, then output the invalid signal/relay disconnects (as shown in figure 7-30-A).

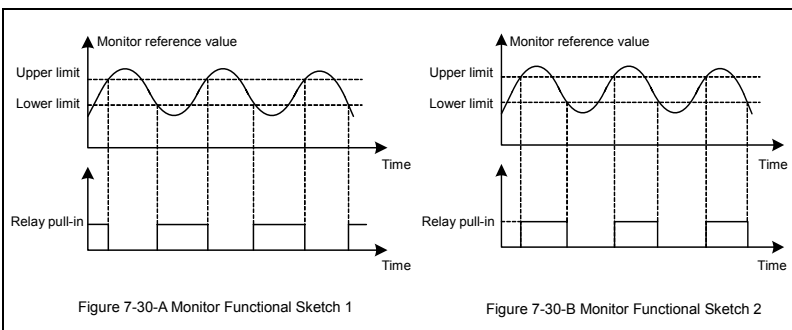

27/30/33: Monitoring parameters 1/2/3 above the lower limit

When monitoring parameters 1/2/3 are above the upper limit values, terminal will output effective signal/relay will pick up, which keeps until monitoring parameters 1/2/3 are below the lower limit values, then output ineffective signal/relay disconnects (as shown in figure 7-30-B).

28/31/34: Monitoring parameters 1/2/3 between the upper limit and the lower limit

When monitoring parameters 1/2/3 are between upper and lower limit values (including equal to upper and lower limit values), the terminal will output the indicator signal/relay will pick up, as shown in figure 7-30-C.

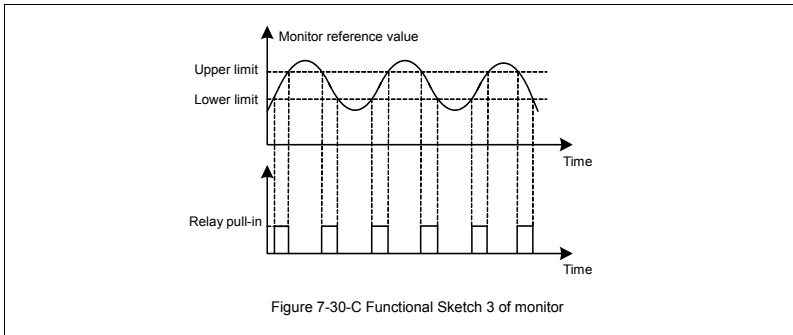

Figure 7-30-C Functional Sketch 3 of monitor

36-38: Analog input AI1 wire-break detection effective

When inverter detects wire-break of analog input, it will choose to make corresponding operation according to operation after wire-break; meanwhile terminal will output effective signal/relay will pick up.

40-43: Counter output signal

When counting of counter reaches to setting value, terminal will output effective signal/relay will pick up. Please refer to function specifications for **F5.2.20-F5.2.27** parameters.

44-49: Timer output signal

When comparative value /periodic value of timer reaches to setting value, terminal will output effective signal/relay will pick up. Please refer to function specifications for **F5.1.06-F5.1.18** parameters

55-62: Status of multifunctional input terminal

If **D10-D18** terminals are effective, terminal will output effective signal/relay will pick up.

63: DO3/Fout terminal as the frequency output terminal

As frequency output terminal, frequency range of signal output by **D03/Fout: 0.07-100.0KHz**.

64-71: Logic operation

When the result of the logic operation of the virtual output port (SDO1-SDO8) is "true", the terminal outputs effective signal/the relay picks up. Please refer to related contents in "Comparison Table of Multifunctional Output Terminal Variables".

F3.1.15~F3.1.20 DO1~DO3 delay time for terminal effective/ineffective signal output	Setting range: 0.0~10.00Sec.	Factory default: 0.0
F3.1.23~F3.1.26 RO1/RO2 power-on/disconnection delay time	Setting range: 0.0~10.00Sec.	Factory default: 0.0

This group of parameters are used to define multi-function output terminal **DO1~DO3** and time delay of change for signal state output by multi-function relay **RO1/RO2**. When signal output by multi-function terminal and pulled in by relay is effective, terminal will output indicator signal, and relay will pick up (connection of **TA** and **TC**) after delay time set by parameters **F3.1.15~F3.1.20**, **F3.1.23~F3.1.26**.

F3.1.27~ F3.1.29 monitor 1-3 variable selection	Setting range: 0~44	Factory default: 0~2
--	----------------------------	-----------------------------

Different state parameters can be monitored by setting the values of **F3.1.27~F3.1.29** (please refer to "Comparison Table of Monitor Variables").

F3.1.30~F3.1.35 Upper and lower limit of monitor 1~3 variables	Setting range: 0.0~100.0(%)	Factory default: 0.0/100.0
---	------------------------------------	-----------------------------------

This group of parameters restricts the range of monitoring parameter variables, of which the set values are relative to the percentages of full monitoring variable output.

7.14 Pulse input (this group of parameters will effective when expansion I/O board is configured and D19 selects frequency input function) (Group F3.2)

F3.2.36 Minimum pulse input frequency DI9/Fin	Setting range: 0.0~100.00KHz	Factory default: 0.0
F3.2.37 Maximum pulse input frequency DI9/Fin	Setting range: 0.01~100.00KHz	Factory default: 10.0
F3.2.38 Pulse detection cycle	Setting range: 1 ms ~20ms	Factory default: 10 ms

This group of parameters defines multi-function input terminal **DI9/Fin** as frequency range and detection cycle of external pulse signal for pulse input (**F3.0.08** is set as **97-98**), effective breadth of external pulse signal is **5-30V**.

F3.2.39 Number of single-loop pulse	Setting range: 1~4096	Factory default: 1024
--	------------------------------	------------------------------

When input frequency signal of **DI9/Fin** terminal is used for length accumulation or speed measurement, these parameters are used to set pulse signal quantity for each rotation of encoder.

F3.2.40 Mechanical transmission ratio	Setting range: 0.010~10.000	Factory default: 1.000
F3.2.41 Driving wheel diameter (for linear speed calculation)	Setting range: 0.1~2000.0mm	Factory default: 100.0

This group of parameters is used for linear speed calculation or length accumulation.

Mechanical transmission ratio = driving wheel revolution/revolution of speed measuring coded disc.

F3.2.42 Maximum accumulative length value	Setting range: 10m~50000m	Factory default: 50000
F3.2.43 Maximum liner speed	Setting range: 0.01~500.00m/sec.	Factory default: 10.00m/s

To limit the maximum accumulative length and maximum liner speed. The terminal signal can be input when it reaches or exceed the maximum value.

F3.2.44 Current accumulative length value	Setting range: 0~50000m	Factory default: —
F3.2.45 Current liner speed	Setting range: 0.0~500.00m/sec.	Factory default: —

Parameters in read-only state are used to display calculated results of current length and linear speed.

7.15 Pulse output (this group of parameters will effective when expansion I/O board is configured and DO3 selects frequency output function) (Group F3.3)

F3.3.46 Type of output pulse signal DO3/Fout	Setting range: 0~2	Factory default: 0
---	---------------------------	---------------------------

0: 0.25 ~ 100.00KHz Frequency signal

1: 10.0 ~ 1000.0Hz Frequency signal

2: Pulse width modulation (PWM) signal

It can be used as expansion AO port, and the modulation frequency is set through the maximum pulse output frequency parameter **F3.3.48**.

F3.3.50 DO3/Fout assignment lower limit	Setting range: 0.0~[F3.3.51]	Factory default: 0.0
F3.3.51 DO3/Fout assignment upper limit	Setting range: [F3.3.50]~100.0%	Factory default: 100.0

This group of parameters can determine the corresponding relationship between maximum, minimum frequency of the pulse output **DO3/Fout** and its pulse output mapping variables, while the set values are the percentages of full pulse output mapping variables. Corresponding relationship between the two parameters is as shown in figure 7-31:

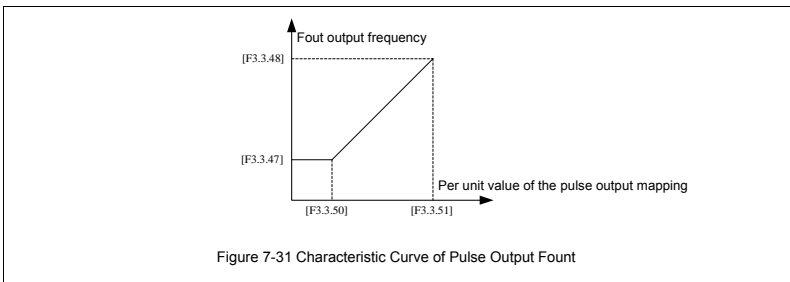

7.16 Analog input (Group F4.0)

F4.0.00~F4.0.05 Minimum and maximum values of analog input AI1~AI3	—	—
---	---	---

This group of parameters is used to define the setting range of analog input signal, which need to be set according to actual situation of access signal.

AI1 analog input port is unipolar voltage signal; **AI2** analog input port is unipolar current signal; **AI3** analog input signal is bipolar voltage signal.

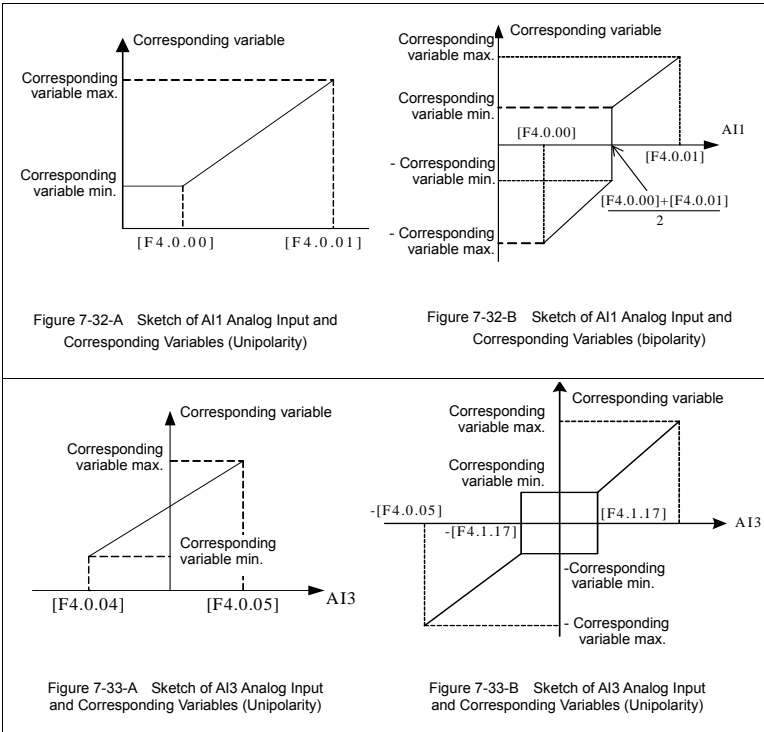

When the unipolar input signal AI1 and AI2 are applied as bipolar signal, if input signal disconnects and input value is maximum reserve setting, it may be dangerous to human and property safety. Please use in combination with disconnection fault detection function of analog input port.

F4.0.06~F4.0.08 Analog input AI1~AI3 filtering time coefficient/standard expansion card	Setting range: 1~1000ms	Factory default: 10 ms
--	--------------------------------	-------------------------------

Carry out filtering treatment to external analog input quantity to effectively eliminate interference signal. Filtering time constant (time needed for given signal rising to 63% of stable value) should be set properly according to fluctuation range of external input signal, if it is too high, anti-interference capacity will be strong while delaying the response speed to setting signal.

7.17 Analog input curve correction (Group F4.1)

F4.1.09~F4.1.16 Analog input AI1~AI31 curve correction point/value 1~2

This group of parameters is used to conduct nonlinear correction to analog input value as required. Curve correction of analog input AI1 is as shown in figure 7-34, while the curve correction methods of AI2 are similar to analog input AI1.

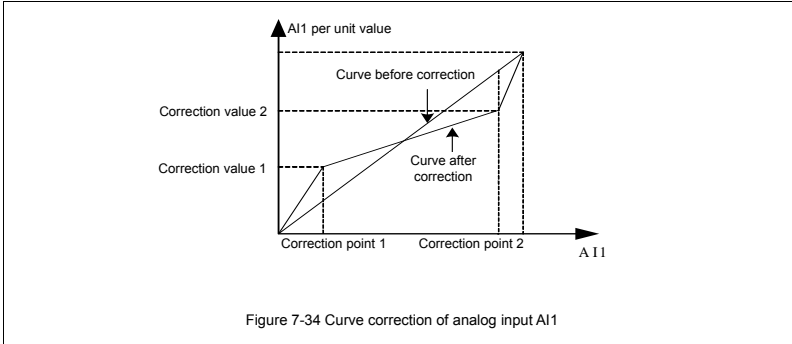

F4.1.17 Analog input AI3 zero hysteresis / standard expansion card

Setting range: 0.00~2.00

Factory default: 0.10

Set hysteresis width of middle point between maximum value and minimum value of AI3, when it is applied as bipolar signal, forward and reverse fluctuation of zero setting value will be frequent as shown in Figure 7-34. It should be set to 0 when applied as unipolar signal.

F4.1.18~F4.1.21 Analog input AI3 curve correction point/value1~2/standard expansion card

This group of parameters is used to conduct nonlinear correction on analog input values if necessary. The curve correction method for analog input AI3 is similar to that for analog input AI1. Refer to figure 7-34 for the curve correction.

7.18 Analog output (Group F4.2)

F4.2.22 Mapping variable of multifunctional analog output AO1	Setting range: 0~45	Factory default: 0
F4.2.23 Mapping variable of multifunctional analog output AO2/standard expansion card	Setting range: 0~45	Factory default: 2

Multifunction analog output **AO1**, **AO2** can output voltage signal of **0~10V** or current signal of **1~20mA**, selected by the dial switch on the control board. Frequency inverter status represented by the analog output signal is set by this group of parameters. Please see Appendix 3 (comparison table of status variable).

F4.2.24 AO1 minimum	Setting range: 0.00~10.00V	Factory default: 0.0
F4.2.25 AO1 maximum	Setting range: 0.00~10.00V	Factory default: 10.00
F4.2.30 AO2 minimum/standard expansion card	Setting range: 0.00~10.00V	Factory default: 0.0
F4.2.31 AO2 maximum/standard expansion card	Setting range: 0.00~10.00V	Factory default: 10.00

This group of parameters defines the maximum and minimum of multifunction analog output **AO1**, **AO2** allowed to output.

F4.2.26 AO1 lower limiting value	Setting range: 0.0-[F4.2.27]	Factory default: 0.0
F4.2.27 Upper limiting value	Setting range: [F4.2.26]-100.0%	Factory default: 100.0
F4.2.32 Lower limiting value/standard expansion card	Setting range: 0.0-[F4.2.33]	Factory default: 0.0
F4.2.33 Upper limiting value/standard expansion card	Setting range: [F4.2.32]-100.0%	Factory default: 100.0

Corresponding relationship between maximum and minimum of **AO1**, **AO2** output given by this group of parameters and mapping variable (see figure below), whose set value is the percentage relevant to the full output of mapping variable of **AO1**, **AO2**.

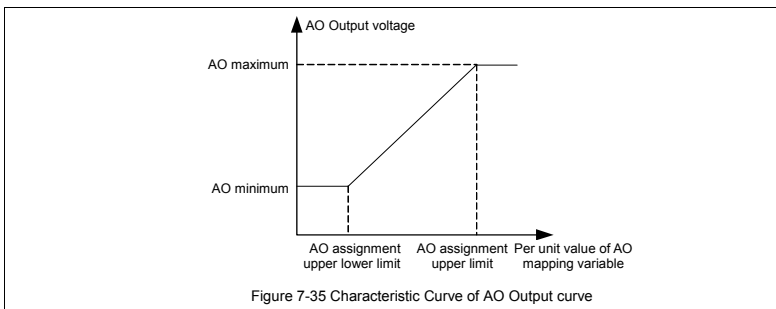

F4.2.28 AO1 AO1 filtering time coefficient	Setting range: 0.01~10.00Sec.	Factory default: 0.10
F4.2.34 AO2 filtering time coefficient/ standard expansion card	Setting range: 0.01~10.00Sec.	Factory default: 0.10

This group of parameters is used to set the filtering time coefficient of **AO1**, **AO2** analog output signal, according to selection of requirements of the rapidity and wave character of signal. The larger the time coefficient is, the smoother the output signal is, and the slower the response is.

F4.2.29 AO1 fixed output value	Setting range: 0.00~20.00mA (0.00~10.00V)	Factory default: 0.0
F4.2.35 AO2 fixed output value/standard expansion card	Setting range: 0.00~20.00mA (0.00~10.00V)	Factory default: 0.0

When the mapping variable of multifunction analog output **AO1**, **AO2** is a fixed value (**F4.02.22**, **F4.2.23** is set to **45**), fixed value of **AO1** output is [**F4.2.29**], and the fixed value of **AO2** output is [**F4.2.35**], which can output voltage and current signal.

7.19 Analog input wire-break detection (Group F4.3)

On condition that break detection function of analog input is valid, when the value of **AI1**, **AI2** and **AI3** analog input is within the range of detection threshold level, when the frequency inverter passes the action of break detection delay, conduct corresponding action according to the selected setting after the wire-break action.

F4.3.39 Action selection after AI1 wire-break	Setting range: 0~4	Factory default: 0
F4.3.43 Action selection after AI2 wire-break	Setting range: 0~4	Factory default: 0
F4.3.48 Action selection after AI3 wire-break	Setting range: 0~4	Factory default: 0

Define corresponding actions after frequency inverter detects analog input wire-breakage.

0: No action (for non-stop alarm)

When detecting analog input wire-break, if the frequency inverter operates normally, it only reports **aL.036-aL.038** warning signal. If the wire-break fault is cleared, the warning signal can be cleared automatically.

1: Forcedly set to the minimum

When detecting analog input wire-break, if the frequency inverter operates normally, it reports **aL.036-aL.038** warning signal. Meanwhile, forcedly set the analog input signal to the minimum of analog input. If the wire-break fault is cleared, the warning signal can be cleared automatically, meanwhile, the analog input signal recovers to input value.

2: Forcedly set to the maximum

When detecting analog input wire-break, if the frequency inverter operates normally, it reports **aL.036-aL.038** warning signal. Meanwhile, forcedly set the analog input signal to the maximum of analog input.

If the wire-break fault is cleared, the warning signal can be cleared automatically, meanwhile, the analog input signal is restored to input value.

3: Forcedly set to the default value

When detecting analog input wire-break, if the frequency inverter operates normally, it reports **aL.036-aL.038** warning signal. Meanwhile, forcedly set the analog input signal to the default input value of analog input. If the wire-break fault is cleared, the warning signal can be cleared automatically, meanwhile, the analog input signal is restored to input value.

4: Inverter forced trip stop

When detecting analog input wire-break, it reports Fu. 036~Fu. 038 fault signal and lock output, and load motor freely sliding down. If the wire-break fault is cleared, fault signal shall be cleared with hand-reset.

7.20 Hopping frequency (Group F5.0)

Hopping frequency function makes the output frequency of frequency inverter to avoid the mechanical resonant frequency point of machine loaded.

Setting frequency of frequency inverter can operate with hopping frequency around some frequency point as the method in the figure below, with **3** hopping ranges defined at most.

After hopping frequency parameters are set, even the setting frequency of frequency inverter is within the mechanical resonant frequency band of driving system; output frequency of frequency inverter will still adjust out of the mechanical resonant band, operating with lower limiting value of the hopping range of this hopping frequency.

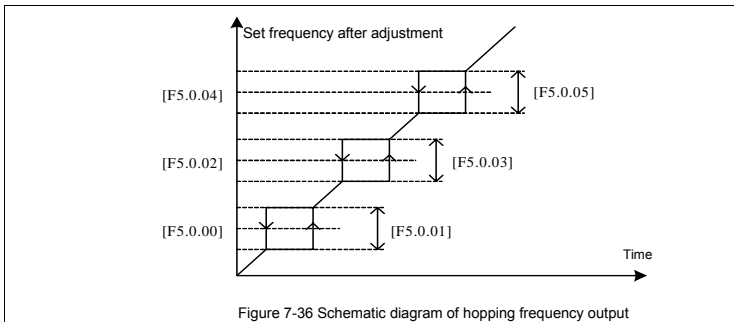

7.21 Built-in auxiliary timer (Group F5.1)

This group of parameters are mainly instructed by taking example of timer 1.

7.21.1 Basic Functions of the Timer

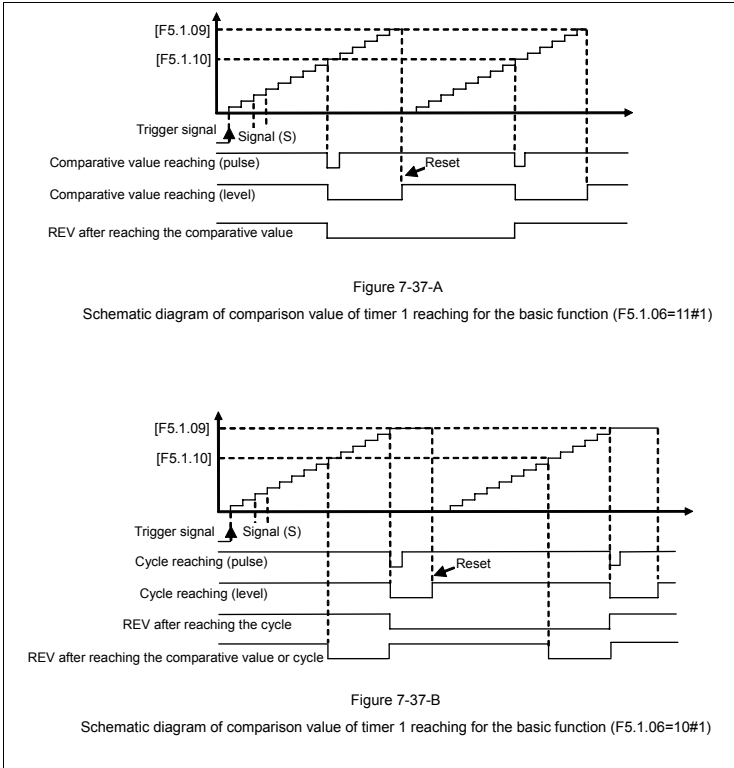

7.21.2 Timer trigger and gate control function

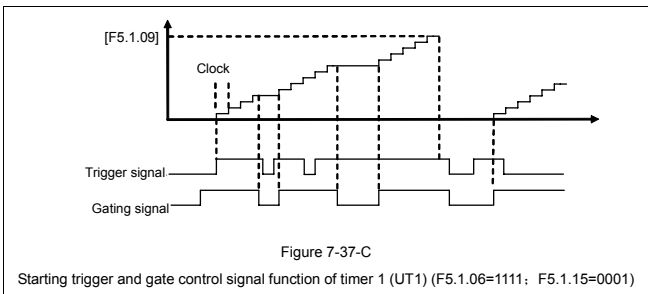

7.21.3 Timer with clock function

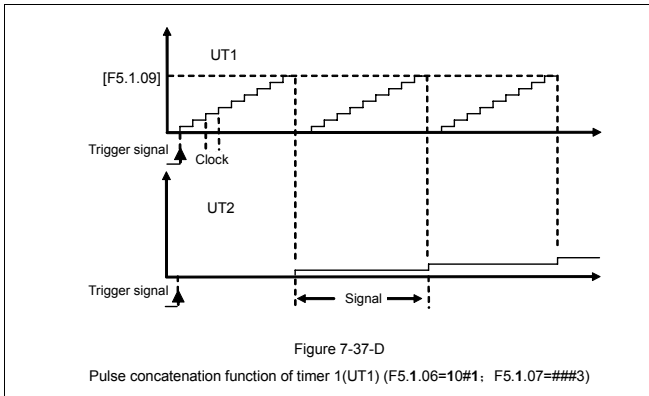

7.21.4 Timer with trigger function

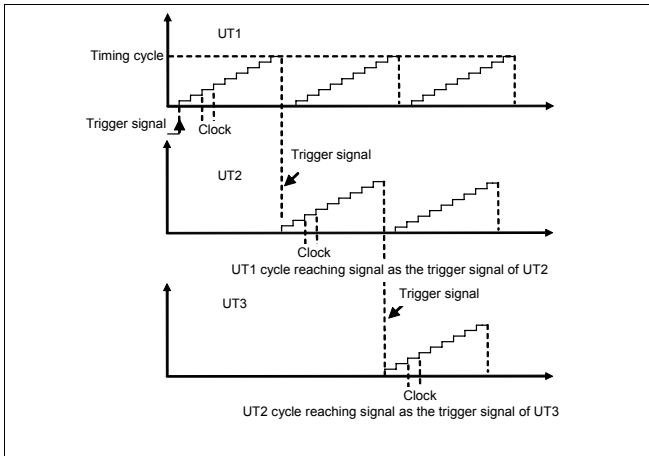

7.22 Built-in auxiliary counter (Group F5.2)

Similar to the function of timer, the counter is designed for external clock (unknown frequency variable), and timer is designed for the internal clock (known and determined frequency). With the terminal function of analog input and output, it can transfer the counter into the function of timer.

Differences: Counter will continue to count upwards without reset, and start from 0 on until overflow.

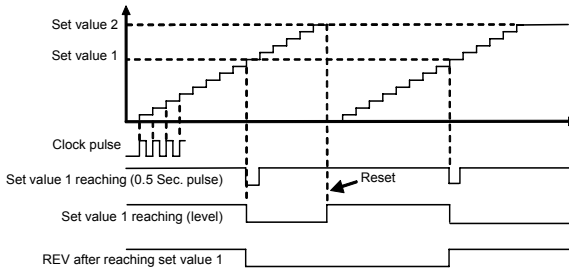

Figure 7-38-A Counter Function 1

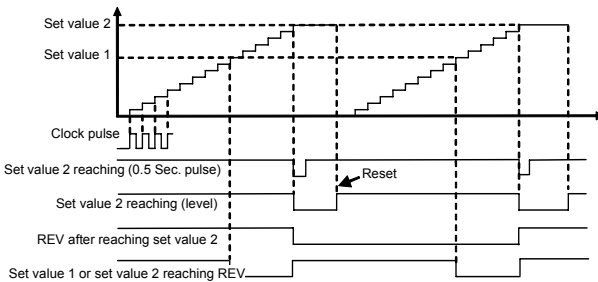

Figure 7-38-B Counter function 2

7.23 Auxiliary functions (Group F5.3)

F5.3.28 Priority selection of frequency (revolution) command source (H)	Setting range: 0000~7777	Factory default: 0000
--	---------------------------------	------------------------------

This parameter applies to the situation that frequency inverter operates with V/F mode; forcedly operate with VC, SVC modes. Automatic voltage regulation function is used for ensuring the output voltage of frequency inverter not fluctuates as the input voltage fluctuates. In condition that grid voltage fluctuates greatly, while stable stator voltage and current of motor is required, this function shall be operated.

Table 7-16 Frequency Setting Order of V350 Frequency Inverter:

Priority	Setting	Remarks
1	Inching frequency setting	Top priority
2	Torque control method	In case of torque control method, frequency setting is invalid
3	Priority defined by this parameter (four at most)	Priority defined by this parameter shall be deleted from the list of lower priority automatically
4	process PID output	
5	Swing frequency operating frequency	
6	compensation PID output	
7	Revolving speed setting channel (F8.0.00)	
8	Automatic multiple frequency operating order	
9	Multi-stage operation frequency selected by external terminal	
10	Frequency setting channel (F0.1.16)	Lowest priority

F5.3.29 Lower limiting frequency action mode	Setting range: 0, 1	Factory default: 0
---	----------------------------	---------------------------

0: Output 0 frequency when it is below the lower limiting frequency

If the inverter's frequency setting value is lower than the lower limit frequency, the output frequency of the inverter is zero.

1: Output the lower limiting frequency when it is below the lower limiting frequency

If the inverter's frequency setting value is lower than the lower limit frequency, the output frequency of the inverter is the lower limit frequency.

F5.3.30 Automatic voltage regulation (only effective in VV control mode)	Setting range: 0, 1, 2	Factory default: 0
---	-------------------------------	---------------------------

This parameter applies to the situation that frequency inverter operates with V/F mode; forcedly operate with VC, SVC modes. Automatic voltage regulation function is used for ensuring the output voltage of frequency inverter not fluctuates as the input voltage fluctuates. In condition that grid voltage fluctuates greatly, while stable stator voltage and current of motor is required, this function shall be operated.

F5.3.31 Automatic energy-saving operation (only effective for asynchronous motors)	Setting range: 0, 1	Factory default: 0
---	----------------------------	---------------------------

Magnetic flux operates optimally, and valid with asynchronous machine. Automatic energy saving operation refers to frequency inverter can detect the load condition of motor automatically, and adjust output voltage timely to make the motor operate at high efficient status, in order to reach optimal effect of energy saving.

Automatic energy saving operation has the best effect when the load change of motor is of low frequency and wide range. The major energy saving way is to obtain additional energy saving effect from adjusting the status of motor excitation, to make the motor operate at optimal high efficient status, and greatly lower the energy consumption of motor.

F5.3.32 Magnetic flux brake	Setting range: 0, 1, 2	Factory default: 0
------------------------------------	-------------------------------	---------------------------

Frequency inverter can increase the magnetic flux when the motor slows down to stop, to make the motor stop more rapidly (see figure below).

The electric energy produced during the braking process is mainly consumed in form of heat inside of the motor. Therefore, frequent braking with magnetic flow will lead to the internal temperature of the motor increase. Please be sure the motor temperature shall not over the maximum admissible value.

When input operation order during magnetic flow braking, magnetic flow will be canceled, and frequency inverter will speed up again to the selected frequency.

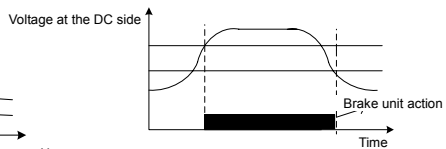
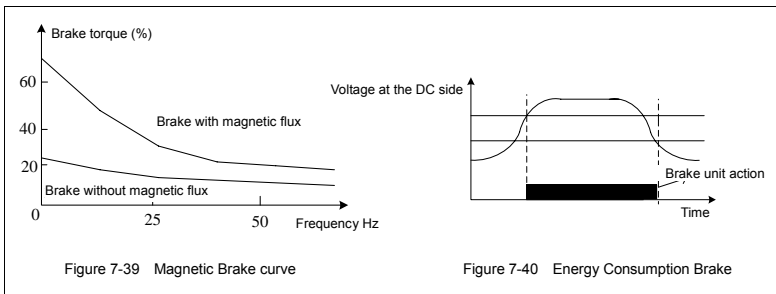

F5.3.33 Magnetic flux braking strength (brake exciting current)	Setting range: 30~120%	Factory default: ☆
--	-------------------------------	---------------------------

This parameter defines the increased amplitude of motor magnetic flux when magnetic flux braking, selected value is the relevant percentage of rated magnetic flux.

F5.3.34 Voltage overmodulation	Setting range: 0, 1	Factory default: 1
---------------------------------------	----------------------------	---------------------------

Voltage over modulation refers to that in condition of lasting low grid voltage or lasting heavy load operation, frequency inverter improve the output voltage with improving the utilization rate of its bus voltage. When over modulation function is valid, output current harmonic will increase slightly.

0: Void

1: Effective

F5.3.35 Use ratio of dynamic braking	Setting range: 50~100%	Factory default: 100
---	-------------------------------	-----------------------------

F5.3.36 Level of dynamic braking starting action	Setting range: 650~760V	Factory default: 690
---	--------------------------------	-----------------------------

These two parameters is valid to frequency inverters with built-in braking unit (18.5 KW below), which is used to define action parameters of built-in braking unit of frequency inverters. When the voltage at internal direct current side of frequency inverter is higher than starting action level of dynamic braking [F5.3.36], build in braking unit action. If there is external braking resistor, it shall make the direct current voltage fall back, via releasing pumped-up voltage energy with braking resistor. When the voltage at DC side drops down to a specific value, the built-in braking unit of the frequency inverter will be closed. Refer to Figure 7-40.

Utilization rate of dynamic braking is used to define the average voltage value forced on braking resistor of braking unit action. Voltage on braking resistor is pulse width modulation wave. Duty ratio equals to action ratio of dynamic braking. The large the action ratio is, the faster energy releases, and the more obvious the effect is, as well as the larger power consumed on braking resistor is. Operator may consider setting the parameters comprehensively according to the resistance of braking resistor, power and required braking effect.

F5.3.37 Vibration suppression coefficient (effective only in VF control mode)	Setting range: 0.0; 0.1~10.00	Factory default: 0.0
--	--------------------------------------	-----------------------------

Only valid with V/F control method. Selecting this parameter can restrain the output current oscillation. Set 0.0 to close this function. The larger the value is, the slower restraining action is and the wider the biggest adjustment range is

F5.3.38 Load dynamic balance function	Setting range: 0, 1, 2	Factory default: 0
F5.3.39 Reference source for dynamic balance load	Setting range: 0 ~ 4	Factory default: 0
F5.3.40 Reference value for dynamic balance load	Setting range: 0.0~200.0%	Factory default: 100.0
F5.3.41 Dynamic balance adjustment gain	0.0 ~ 100.00 (%)	Factory default: 50.00
F5.3.42 Dynamic balance adjustment limit	0.0 ~ 100.00 (%)	Factory default: 1.00

Load dynamic balance function is used for balancing load with multiple motors linkage, or occasions requiring torque motor characteristics of "Frequency inverter-asynchronous electrical units".When this function is valid, frequency inverter shall take the input value of dynamic balance load reference source (relative value of rated current) as reference, automatically amend the input of frequency/revolving speed integrator, adjusting output frequency to balance the load. The adjustment to output frequency for dynamic balance function is relatively slow, and influenced by selections of acceleration and deceleration time.

If rapid response of linkage balance operation is required, please apply with linkage operation self-balancing function (referring to instruction of parameters in FA group), or applying with compensation **PID** to build flexibly as necessary, which can conduct adjustment directly to the output of frequency integrator.

Adjusting gain value= $[F5.3.41] \times \text{rated current of equipment} / 100$, when the difference of output current and reference value reaches the adjusting gain value, output frequency will drop to the adjusting amplitude limit value.

Adjusting amplitude limit value= $[F5.3.42] \times \text{current selected frequency} / 100$; this value is the amplitude peak of dynamic balance adjustment.

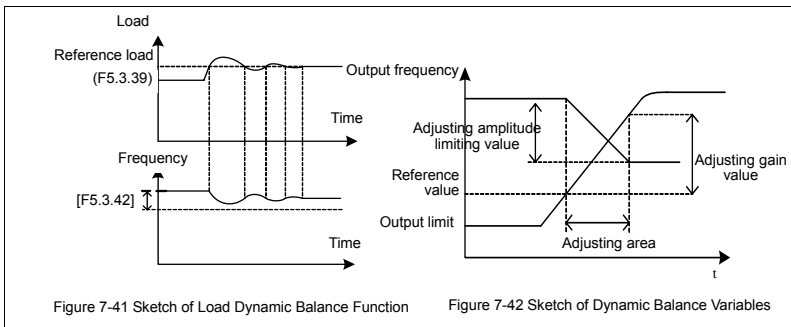

7.24 Multi-stage frequency setting (Group F6.0)

F6.0.00~ F6.0.14 Opening frequency 1st~15th	Setting range: [F0.1.22]~[F0.1.21]	Factory default: 5.00~50.00
--	---	------------------------------------

The parameter is for the setup of multi-stage operation's frequency and can be used to multistage velocity operation and simple programmable multi-stage operation. Refer to the detailed specifications of multi-velocity control function **1, 2, 3, 4** of multifunctional input terminals **F3.0.00-F3.0.07** and simple programmable multistage operation in **F6.1** group parameters. Frequency inverter can transform frequency and direction automatically according to the running time to satisfy the requirement of technology, as Figure 7-43-A shown.

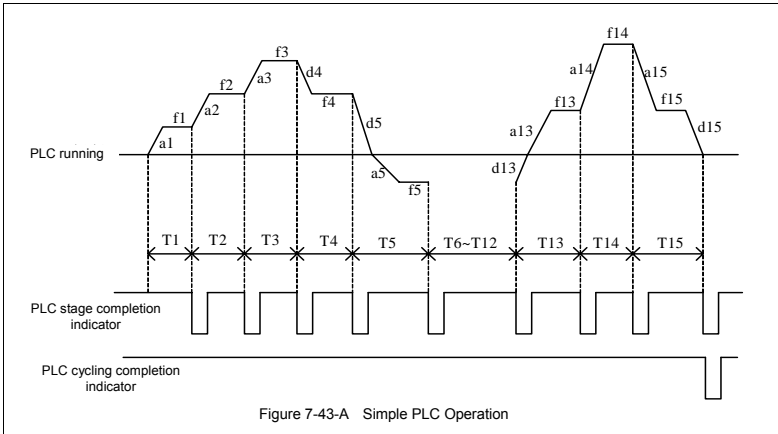

In the figure, **a1-a15** and **d1-d15** are current stage's time of acceleration and deceleration, while **f1-f15** and **T1-T15** are current stage's given frequency and operating time. All these will be defined in this parameter respectively.

The completion of simple programmable multi-stage operation for stage, cycle and so on can access to multifunctional output terminals or relay's output index signal. Refer to Function **20, 21** (multi-stage operation completed) and **22** (multi-stage operating cycle completed) among the **F3.1.15-F3.1.20**.

7.25 Simple programmable multi-stage operation (Group F6.1)

F6.1.15 Selection of programmable multi-stage speed operation mode (H)	Setting range: 0000~1254	Factory default: 0000
---	---------------------------------	------------------------------

The Unit: Function selection

0: Function off

1: Multi-stage frequency/revolution operation effective

If frequency (revolution) instruction source priority allows, the frequency converter operates in multi-stage frequency/revolution.

2: Multi-stage frequency/revolution operation condition effective

When multifunctional input terminal (Function No.23) is valid, frequency inverter operates in multi-stage frequency/revolution; when it is invalid, frequency inverter will automatically access to frequency setup mode allowed to the lower priority.

3: Multi-stage PID setting operation effective

When the process **PID** starts its function, the setup of **PID** should be set automatically according to given time cycle, at most 7 stages being set (F7.1.27 ~ F7.1.33).

4: Multi-stage PID setting operation condition effective

When multifunctional input terminal (Function No. 23) is valid, the multi-stage setting of process **PID** is also valid, at most 7 stages being set (F7.1.27 ~ F7.1.33).

Tens: Operation mode

0: Single cycle

Frequency inverter should firstly operate with first multi-stage speed set frequency and output each velocity's frequency according to given operating time. If the given operating time of a certain velocity is of zero, jump out of the velocity; with a cycle's operation, the frequency inverter should stop outputting and input an effective operating instruction once again to run the next cycle. See Figure 7-43-B.

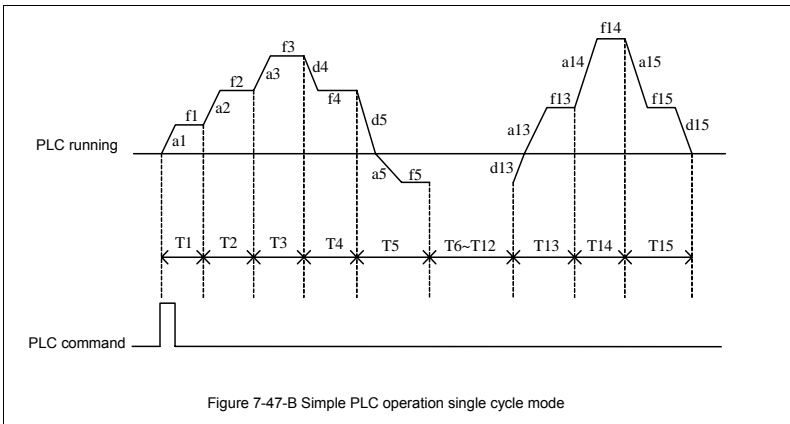

1: Single cycle stop mode

The basic operation mode is the same as mode 0 and its difference is that after frequency inverter operates a stage speed, it firstly lowers the output frequency to zero according to specified deceleration time, then outputs next stage's frequency.

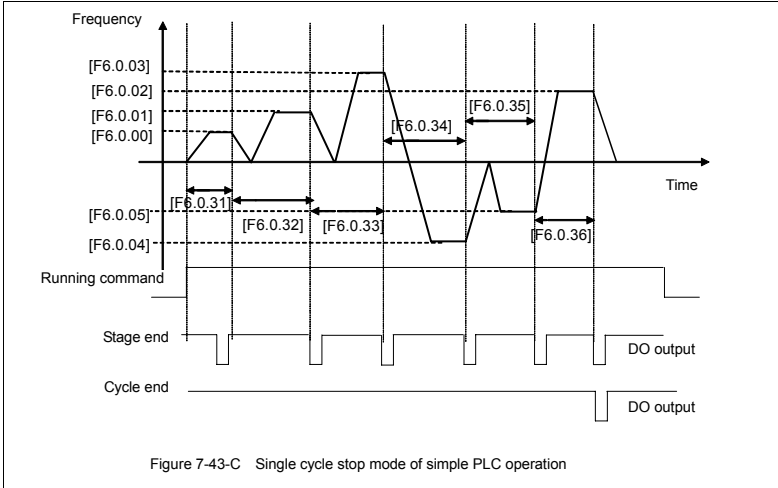

2: Continuous cycling mode

As shown in the figure, the frequency inverter starts next cycle after automatically after it finishes a cycle until it receives stop instruction.

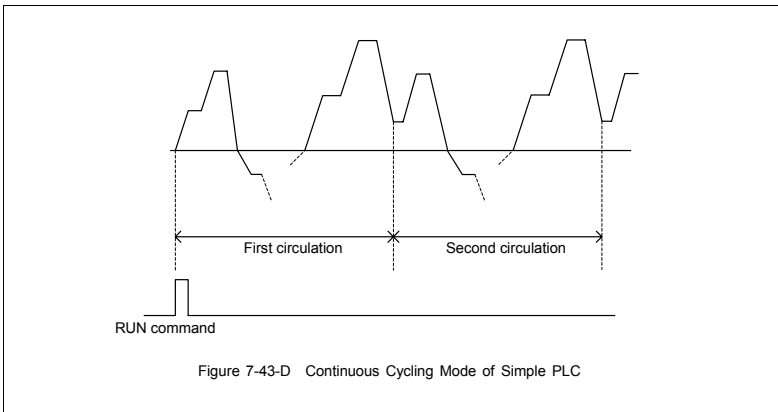

3: Continuous cycle stop mode

Basic operation mode is the same as mode 2 and its difference is that after frequency inverter operates a stage speed, it firstly lowers the output frequency to zero according to specified deceleration time, then outputs next stage's frequency.

4: Keeping the final value

As shown in the figure, the frequency inverter will keep the last stage's operation frequency and direction automatically after it finishes a cycle.

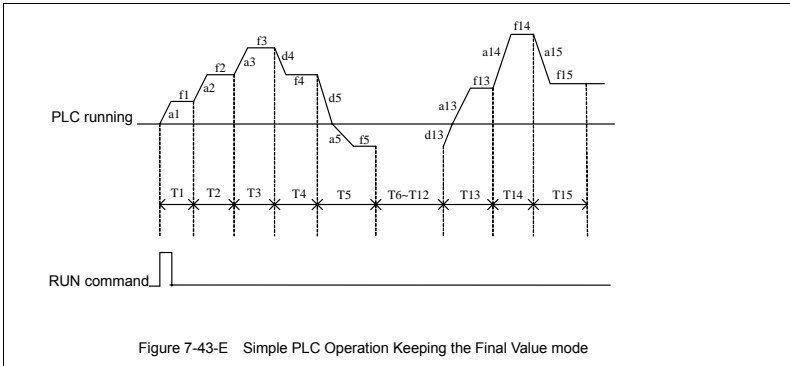

5: Keeping the final value stop mode

Basic operation mode is the same as mode 4 and its difference is that after frequency inverter operates a stage speed, it firstly lowers the output frequency to zero according to specified deceleration time, then outputs next stage's frequency.

Hundreds: Selection of breakpoint/stop recovery mode

0: Restore running at the first stage

In simple programmable multi-stage operation, frequency inverter will clear out current operation state automatically after it stops because of error stop or stop instruction; restore running at the first stage after it starts again.

1: Start running at the interruption time (effective for multi-stage frequency/revolution operation)

In simple programmable multi-stage operation, frequency inverter will record the stage operation time and operation frequency automatically at the interrupting time after it stops because of error stop or stop instruction; start running at the interruption time after it starts again.

2: Start running at the stage of interruption

In simple programmable multi-stage operation, frequency inverter will record the stage operation time and operation frequency automatically at the interrupting time after it stops because of error stop or stop instruction; start running at the stage of interruption after it starts again. The single difference between mode 1 and 2 is the different frequencies at the stage of interruption. See as Figure 7-44.

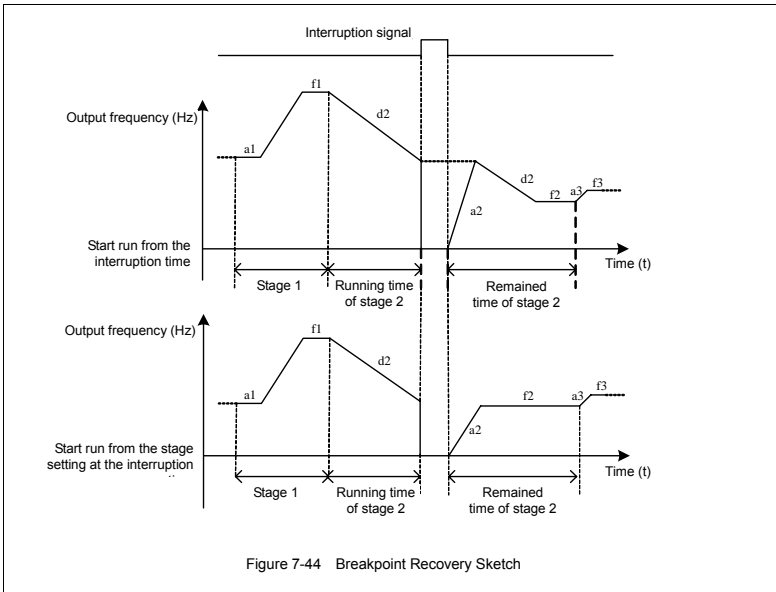

Figure 7-44 Breakpoint Recovery Sketch

Kilobit: Power-off status storage**0: Not save**

When the frequency converter fails power, it does not save the simple programmable multi-stage operation status and starts operating from the first stage after being powered on again.

1: Save

When the frequency converter fails power, it saves the simple programmable multi-stage operation status, including the power-off status, operation frequency, operated time, and operates according to the parameter's breakpoint/stop recovery mode of hundred definition after being powered on again.

F6.1.16~ F6.1.30	Setting of stage 1~15	Setting range: 0000~1321	Factory default: 0000
-------------------------	------------------------------	---------------------------------	------------------------------

The unit: Operating frequency source/setting source at each stage

0: Multi-stage frequency setting 1~15/Process PID multi-stage setting 1~7 (1~7)

Setting values of stage operation frequency should be set by multi-stage frequency setting 1~15 (Group **F6.0**)/Process PID multi-stage setting 1~7 (Group **F7.1**).

1: Frequency command (F0.2.25)/Process PID setting (F7.0.01)

Setting values of stage operation frequency should be set by frequency command (**F0.2.25**)/ Process PID setting (**F7.0.01**).

7.26 Swing frequency operation (Group F6.2)

Swing frequency operation is regulated by high and low boundary of frequency. If the function's parameter group is improper, swing frequency operates properly.

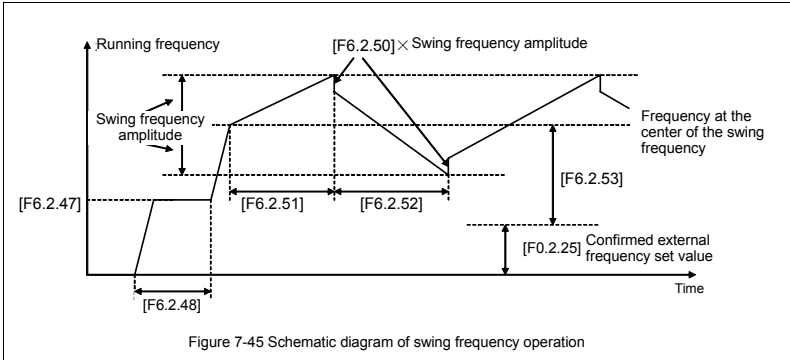

F6.2.46 Function selecting (H)	Setting range: 0000~1112	Factory default: 0000
---------------------------------------	---------------------------------	------------------------------

The unit: Function setting

0: Function off The functional parameter of Group **F6.2** is invalid.

1: Function effective.

In case that the priority of frequency (revolution) instruction source allows by, the frequency inverter adopts swing function.

2: Terminal selectivity effective

When the multifunctional input terminal of definition **24** (swing operation input) is valid, the frequency inverter adopts swing function. In case that the priority of frequency (revolution) instruction source allows. If it is invalid, frequency converter operates in accordance with the setting value of preset frequency **F6.2.47** of swing frequency. In this mode, waiting time of preset frequency is invalid.

F6.2.47 Preset frequency of swing frequency	Setting range: 0.00~[F0.1.21]	Factory default: 10.00
F6.2.48 Waiting time of preset frequency	Setting range: 0.0~6000.0Sec.	Factory default: 0.0

Preset frequency is referred to the operation frequency before frequency inverter adopts swing frequency operation or breaks away from operation frequency of swing frequency operation. Determine the operation mode of preset frequency according to the instruction of swing frequency function.

When the selected swing frequency function is valid (**[F6.2.46]=###1**), frequency inverter starts swing frequency preset frequency after running, then runs the swing frequency operation status after the waiting time **[F6.2.48]** of preset frequency.

In case of the selected swing frequency function terminal is available (**[F6.2.46]=###2**), when swing frequency operation input terminal is valid, frequency inverter runs the swing frequency operation status; When it is invalid, frequency converter outputs preset frequency (**[F6.2.47]**), and the waiting time of preset frequency is unavailable.

F6.2.49 Swing frequency amplitude	Setting range: 0.0~50.0 (%)	Factory default: 10.0
--	------------------------------------	------------------------------

Swing frequency amplitude is the ratio of swing frequency amplitude.

When it occurs to fixed swing frequency amplitude (**[F6.2.46]=#0##**), mathematics of practical swing frequency amplitude is:

Practical Swing frequency amplitude= **[F6.2.49]** × maximum frequency **[F0.1.20]**

When it occurs to changeable swing frequency amplitude (**[F6.2.46]=#1##**), mathematics of practical swing frequency amplitude is:

Practical Swing frequency amplitude= **[F6.2.49]** × (preset frequency of swing frequency center **[F6.2.53]** +frequency set value **F0.2.25**)

F6.2.50 Sudden jump frequency	Setting range: 0.0~50.0(%)	Factory default: 10.0
--------------------------------------	-----------------------------------	------------------------------

Sudden jump frequency is the amplitude of frequency's fast descending after it reaches upper boundary in swing frequency cycle, that is, the amplitude of frequency's fast ascending after it reaches lower boundary. Please refer to Reference Diagram 7-50 for details.

Practical sudden jump frequency = **[F6.2.50]** × practical swing frequency amplitude.

F6.2.51 Triangular wave rising time	Setting range: 0.1~1000.0Sec.	Factory default: 10.0
--	--------------------------------------	------------------------------

F6.2.52 Triangular wave decreasing time	Setting range: 0.1~1000.0Sec.	Factory default: 10.0
--	--------------------------------------	------------------------------

The parameter in this group is referred to acceleration and deceleration slope in the process of swing frequency.

Triangular wave rising time is referred to the time spent from the lower boundary frequency to the upper boundary frequency in swing frequency operation, that is, the acceleration time in the cycle of swing frequency operation.

Triangular wave decreasing time is referred to the time spent from the upper boundary frequency to the lower boundary frequency in swing frequency operation, that is, the deceleration time in the cycle of swing frequency operation.

The sum of triangular wave rising time and decreasing time is the swing frequency operation cycle.

F6.2.53 Setting of swing frequency center frequency	Setting range: 0.00~[F0.1.21]	Factory default: 10.00
--	--------------------------------------	-------------------------------

The swing frequency center frequency refers to the center value of frequency converter output frequency in the process of swing frequency operation.

Center frequency of actual output = **[F6.2.53]** + set frequency confirmed by **F0.2.25**.

Refer to the following figure for the structure of Process PID and functions of each functional parameter:

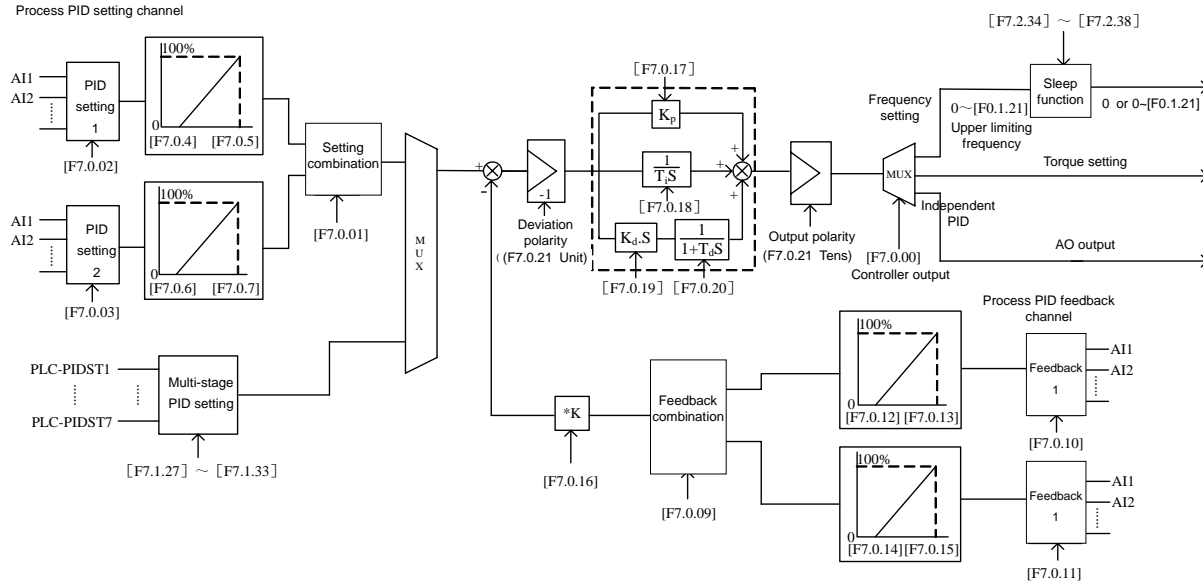

Figure 7-46 Schematic Block of Process PID Control

7.27 Process PID (4ms control cycle) (Group F7.0)

F7.004 Analog input quantity corresponding to 0% setting (Channel 1)	Setting range: 0.0V~[F7.0.05]/ AI2: 0.0mA~[F7.0.05]	Factory default: 0.0
F7.005 Analog input quantity corresponding to 100% setting (Channel 1)	Setting range: [F7.0.04] ~10.00 / AI2: [F7.0.04] ~20.00mA	Factory default: 10.00
F7.006 Analog input quantity corresponding to 0% setting (Channel 2)	Setting range: 0.0V~[F7.0.07]/ AI2: 0.0mA~[F7.0.07]	Factory default: 0.0
F7.007 Analog input quantity corresponding to 100% setting (Channel 2)	Setting range: [F7.0.06] ~10.00 / AI2: [F7.0.06] ~20.00mA	Factory default: 10.00

When analog channel input is selected for setting source of process **PID**, corresponding relationship between set value of process **PID** and analog port can be altered with this group of parameters. The corresponding relationship is shown in Figure 7-47.

F7.012 Analog feedback quantity corresponding to 0% feedback (feedback channel 1)	Setting range: 0.0~[F7.0.13]/ AI2: 0.0mA~[F7.0.13]	Factory default: 0.0
F7.013 Analog feedback quantity corresponding to 100% feedback (feedback channel 1)	Setting range: [F7.0.12] ~10.00V / AI2: [F7.0.12] ~20.00mA	Factory default: 5.00
F7.014 Analog feedback quantity corresponding to 0% feedback (feedback channel 2)	Setting range: 0.0~[F7.0.15]/ AI2: 0.0mA~[F7.0.15]	Factory default: 0.0
F7.015 Analog feedback quantity corresponding to 100% feedback (feedback channel 2)	Setting range: [F7.0.14] ~10.00V / AI2[F7.0.14] ~20.00mA	Factory default: 5.00

When the analog channel input is selected for feedback source of process **PID**, corresponding relationship between feedback value of process **PID** and analog port can be altered with this group of parameters. The corresponding relationship is shown in Figure 7-48.

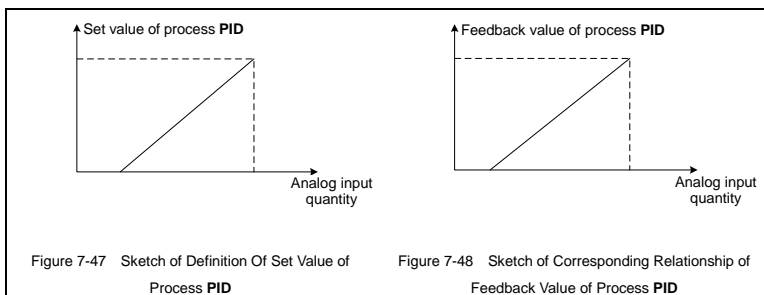

F7.0.16 Feedback multiplication factor (e.g. flow calculation with differential pressure)	Setting range: 0.01~100.00	Factory default: 1.00
--	-----------------------------------	------------------------------

This function is mainly applied in occasions of flow calculation with differential pressure. When the feedback value is not in accordance with the given value of process **PID**, while there is a certain linear relation, this group of parameters can be selected to make it accordant of the meaning expressed by feedback value and given value of process **PID**. For example, if the given value of process **PID** means flow of the pipe, feedback value of process **PID** means flow rate of the pipe, supposing the set value of this parameter means cross sectional area of the pipe, then the given value and feedback value of process **PID** shall be in accordance.

F7.0.17 Proportional gain	Setting range: 0.0~100.00	Factory default: 2.00
F7.0.18 Integral time	Setting range:0.0,0.1~1000.0Sec.	Factory default: 20.0
F7.0.19 Differential coefficient	Setting range: 0.0, 0.01~10.00	Factory default: 0.0
F7.0.20 Differential inertia filtering time	Setting range: 0.01~100.00 Sec.	Factory default: 10.00

Proportional gain defines the magnification of deviation. The bigger the set value is, the faster the response of system is, but oscillation can be caused when it's too big; the smaller the set value is, the slower the response is.

Adjusting only with proportional gain will not eliminate the deviation completely. In order to eliminate the remained deviation, integral time shall be selected. The smaller the integral time is set, the faster the response is, but oscillation of system can be caused when it's too big or too small.

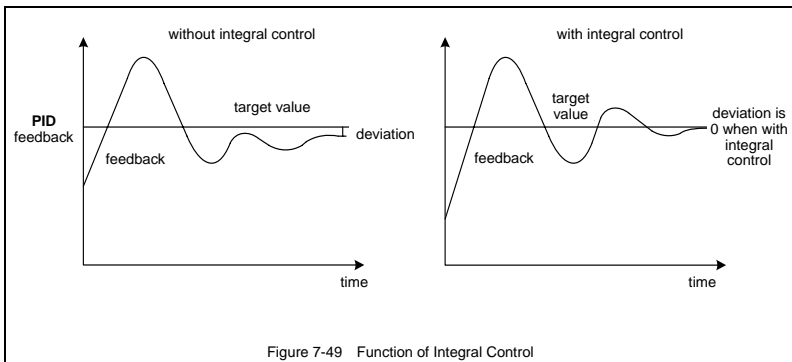

Differentiator can make response to the change rate of deviation. The larger the change is, the larger the output gain is, that is, its gain is in proportion to change rate of deviation. But it won't make response to constant deviation. When differential coefficient is 0.0, it means the differential function closing the controller. Differential function can improve the responsibility of system.

The larger the differential coefficient is set, the stronger the differential function is. In general system, there is no need to introduce differential link.

Larger differential inertia filtering time can make the differential adjustment more smooth, generally, it's set in proportion to the inertia of system.

F7.0.21 PID controller characteristics configuration(H)	Setting range: 0000-0111	Factory default: 0000
--	---------------------------------	------------------------------

The unit: Dviation polarity

0: Positive deviation When feedback signal gets weaker, **PID** output is increased.

1: Negative deviation When feedback signal gets weaker, **PID** output is decreased.

Tens digit: output polarity

0: Single polarity **1: Dual polarity**

For single polarity of **PID** control mode, output of PID adjuster is always positive value, lower limit is 0. For frequency settings, operation direction of frequency inverter is determined with external control order, while PID output can't change the operation direction. Generally, it applies for devices without motor reversal for water and pressure delivery. Refer to Figure 7-50-A.

For dual polarity of **PID** control mode, output of PID adjuster is negative value. For frequency settings, operation direction of frequency inverter is determined with external control order and "exclusive OR" calculation of PID output direction, and PID output can change the operation direction. If the direction lock parameter (F0.1.17) is valid, efficient PID output shall take the absolute value. Refer to Figure 7-50-A and Figure 7-50-B.

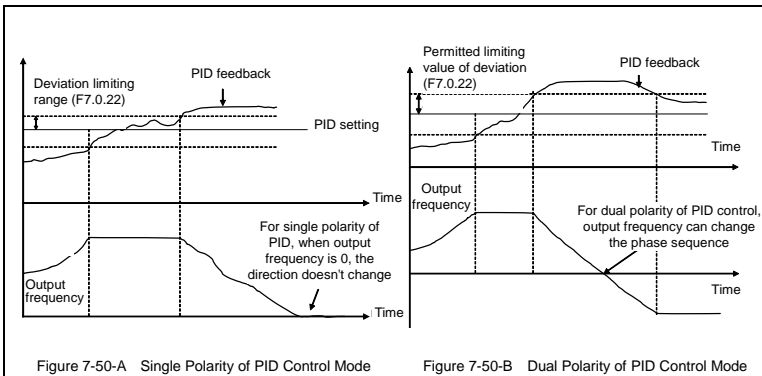

Figure 7-50-A Single Polarity of PID Control Mode

Figure 7-50-B Dual Polarity of PID Control Mode

F7.0.22 Permitted static deviation (relative 100% setting)	Setting range: 0.0~20.0%	Factory default: 5.0
---	---------------------------------	-----------------------------

Controller output value is the permitted maximum deviation amount with given value of controller. When feedback value is within the range of maximum deviation range, the controller stops adjusting. Proper setting of his function contributes to covering the accuracy and stability of output of system.

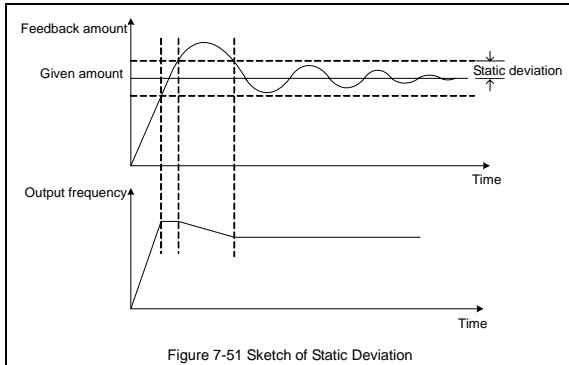

Figure 7-51 Sketch of Static Deviation

F7.0.23 PID output preset (relative to the upper limit frequency for output frequency)	Setting range: 0.0~100.00(%)	Factory default: 0.0
F7.0.24 Preset hold time before PID starting	Setting range: 0.0~3600.0Sec.	Factory default: 0.0

This function can make it earlier to access to the stable stage for PID adjustment. Preset value of PID output is the relevant percentage of upper limiting frequency [F0.1.21].

When frequency inverter start to operate, first of all, it shall be sped up to the preset frequency of PID, and operate as closed-loop characteristics after running continually for a while at this point of frequency [F7.0.24].

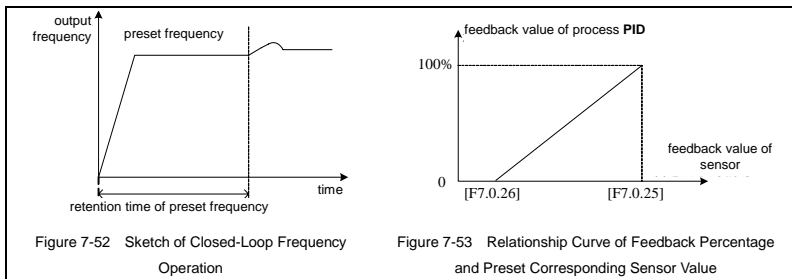

Figure 7-52 Sketch of Closed-Loop Frequency Operation

Figure 7-53 Relationship Curve of Feedback Percentage and Preset Corresponding Sensor Value

F7.0.25 Actual sensor value (range) corresponding to 100% feedback	Setting range: 0.01~100.00	Factory default: 1.00
F7.0.26 Actual sensor value corresponding to 0% feedback	Setting range: -100.00~100.00	Factory default: 0.0

This group of parameter determines the corresponding relationship between feedback percentage and feedback physical quantity, which determines display values of monitoring parameters d0.1.36 and d0.1.37. Corresponding relationship curve is shown in Figure 7-53.

7.28 Process PID multi-stage setting (Group F7.1)

F7.1.27~F7.1.33 Process PID multi-stage preset 1-7	Setting range: -100.0~100.0(%)	Factory default: 0.0
---	---------------------------------------	-----------------------------

This group of parameter defines the set value of process **PID** multi-stage operation. Set value is the relevant percentage of process **PID** set value determined in **F7.0.01**.

Multi-stage operation of process **PID** can be flexibly realized with multifunction input terminal, please refer to function instruction of given terminal **1, 2, 3(28~30)** of multi-stage process **PID** of terminal function **F3.0.00~F3.0.08**. Please refer to notes of parameters **F6.1.15~F6.1.45**.

7.29 Process PID sleeping function (Group F7.2)

This function is valid when **PID** output conducts frequency order; Sketch is shown as below:

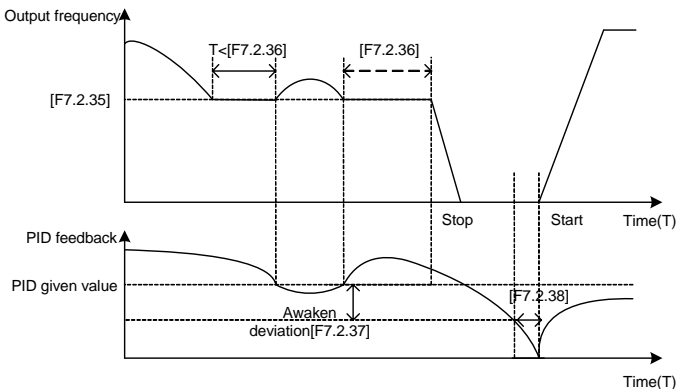

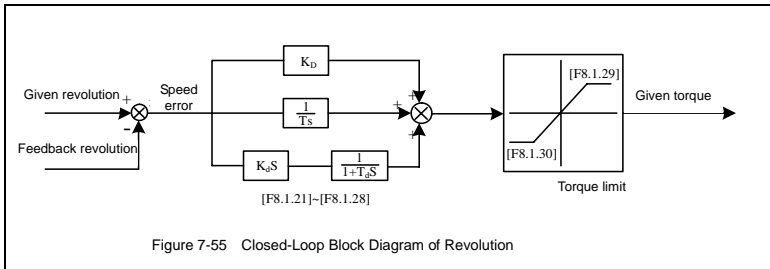

Figure 7-54 Sketch of PID sleeping function

	<p>Set value of awakens deviation F7.2.37 is the relevant percentage of PID given value.</p>
---	--

7.30 Revolution setting and feedback (Group F8.0)



This group of parameter is valid with VC and SVC modes.

F8.0.00 Revolution setting channel (only for VC and SVC mode)	Setting range: 0~10	Factory default: 0
--	----------------------------	---------------------------

This parameter is used to define revolution setting channel. Selecting mode of revolution setting channel is similar with that of frequency setting source channel. Refer to instruction of **F0.2.25** parameter.

0: Set by frequency setting parameter (F0.2.25)

Revolution set value is obtained from transition of frequency set value selected by **F0.2.25**: revolution setting=frequency set value*60/ pairs of motor polarity

1: Digital setting (F8.0.03) (stop holdup and storage after power-off)

Value of **F8.0.03** is set as revolution set value, automatically preserved when outage.

2: Panel shuttle potentiometer setting

Revolution set value is given by revolving panel shuttle potentiometer.

3: Analog input AI1

4: Analog input AI2

5: Analog input AI3 (Bipolarity)

6: Frequency signal input (Fin)

Take the pulse signal input by pulse input port **Fin** as revolution set value.

7: MODBUS Fieldbus set value 1

8: MODBUS Fieldbus set value 2

9: Virtual analog input SAI1

10: Virtual analog inputSAI2

Note: Select revolution setting channels 3~7, upper and lower limiting parameters shall be correctly selected F8.0.01 and F8.0.02.

F8.0.01 Minimum set signal corresponding revolution	Setting range: 0~60*[F0.1.21]/ pairs of motor poles (rpm)	Factory default: 0
F8.0.02 Maximum set signal corresponding revolution (upper frequency limiting)	Setting range: 0~60*[F0.1.21]/ pairs of motor poles (rpm)	Factory default: 1500

This parameter is used to set the relationship curve of set value and corresponding motor revolution when revolution channel is analog input port of this parameter

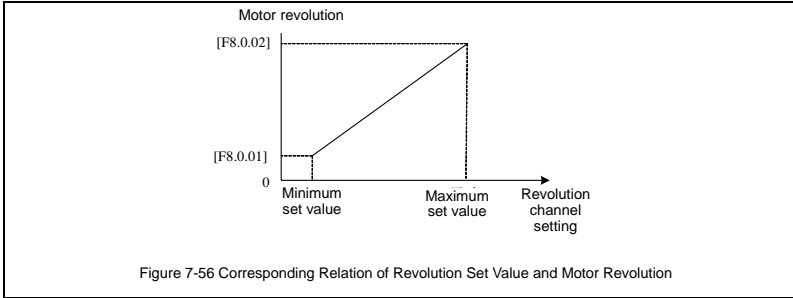

F8.0.06 PG rotation direction (valid for PG card)	Setting range: 0、 1	Factory default: 0
--	----------------------------	---------------------------

In the system of inductive vector controlling, frequency inverter output phase sequence (depending on the connection order between the motor and frequency inverter U, V, W) and the connection order between pulses of encoder Phase A and Phase B should keep uniform. Or it can't function normally and cause the **Fu. 020** fault or 0 speed shock when starting. Then it can be solved with modifying the parameter.

Systems of tension control or hoisting equipment, etc, which may lead to motor shaft side-pulling, may result in Fu.020 fault and at this moment please shield the protective function (FF.1.22 = # 0 # #).

F8.0.09 Revolution check /control cycle	Setting range: 0~0805	Factory default: 0101
--	------------------------------	------------------------------

When revolution feedback channel selects an encoder, the parameter sets speed check cycle. The parameter should set smaller values; overlarge revolution check cycle may lead to unstable closed-loop running and decelerate response. When use larger check cycle for ensuring the exactness of measuring speed, please lower the proportionality factors F8.1.21, F8.1.25 (default parameters) of revolution closed-loop regulator and enlarge integral time constants F8.1.22, F8.1.26 (default parameters) moderately.

F8.0.11 Missing detection and action of speed detection signal	Setting range: 0.01~5.00Sec.	Factory default: 2.00
F8.0.12 Wire breakage zero speed signal level (relative to maximum set speed)	Setting range: 0~20.0(%)	Factory default: 0.0

When set revolution is bigger than the wire breakage zero speed signal level (its set value is relative to the percentage of the largest set speed [F8.0.02]), while feedback speed is smaller than wire breakage zero speed signal level, and revolution of frequency inverter checks wire breakage protective function after keeping the set time of F8.0.11.

F8.0.13 Speed measuring loop wire breakage detection flexibility (relative to maximum set speed)	Setting range: 0.1~100.0	Factory default: 5.0
---	---------------------------------	-----------------------------

If speed measuring loop interference is great, it can enlarge [F8.0.13] to prevent wrong judgments from interference; otherwise decrease the set value to strengthen the response speed of the system to wire breakage check.

F8.0.14 Detection revolution filtering time coefficient	Setting range: 0, 1~50mS	Factory default: 0mS
--	---------------------------------	-----------------------------

Filtering time coefficient of set revolution feedback in this parameter is available to all of the speed measuring modes (channels). When use encoder for speed measuring, the function is similar to check cycle parameter (F8.0.09), therefore there is a need to set smaller values for the system of fast-speed response.

F8.0.15 The minimum revolution corresponding to the feedback signal (not PG)	Setting range: 0~30000rpm	Factory default: 0
F8.0.16 Corresponding revolution of the largest feedback signal (non-PG)	Setting range: 0~30000rpm	Factory default: 1500

The parameter is used to set relations between revolution feedback signal (feedback channel 1~4) and the corresponding to the motor feedback.

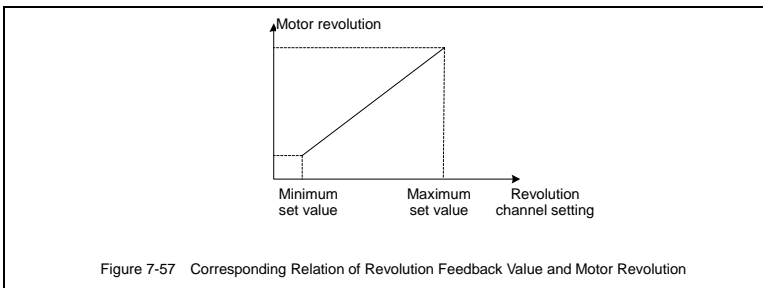

7.31 Revolution closed-loop parameter (Group F8.1)

F8.1.18 Controller parameter selection	Setting range: 0、1、2	Factory default: 2
---	-----------------------------	---------------------------

0: Single PID parameter (the second group of parameters is effective by default)

1: Dual PID parameter (hysteresis switching)

2: Dual PID parameter (continuous switching)

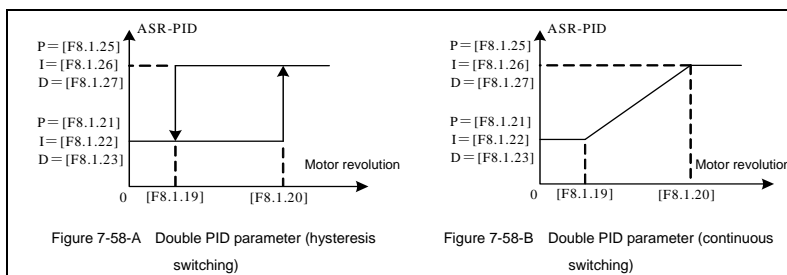

F8.1.19 PID revolution with parameter switching (ASR1 group parameters effective at low revolution)	Setting range: 0~[F8.1.20]	Factory default: 100
F8.1.20 PID parameter switching upper limiting revolution	Setting range: [F8.1.19]~60*[F0.1.21] Motor pole pairs (rpm)	Factory default: 300

The parameters are effective in the condition of double PID parameter hysteresis switching; the first group parameter is effective when it is lower than the switching lower revolution [F8.1.18]; the second group parameter is effective when it is higher than the switching upper revolution [F8.1.19].

F8.1.21 Proportional gain 1 (ASR-P1)	Setting range: 0.10~2.00	Factory default: 1.00
F8.1.22 Integral time 1 (ASR-I1)	Setting range: 0.0, 0.01~50.00Sec.	Factory default: 1.50
F8.1.23 Differential coefficient 1 (ASR-D1)	Setting range: 0.0, 0.01~10.00	Factory default: 0.0
F8.1.24 Differential output filtering constant 1 (ASR-FT1)	Setting range: 0.10~5.00 Sec.	Factory default: 1.00
F8.1.25 Proportional gain 2 (ASR-P2)	Setting range: 0.10~2.00	Factory default: 1.00
F8.1.26 Integral time 2 (ASR-I2)	Setting range: 0.0, 0.01~50.00Sec.	Factory default: 5.00
F8.1.27 Differential coefficient 2 (ASR-D2)	Setting range: 0.0, 0.01~10.00	Factory default: 0.0
F8.1.28 Differential output filtering constant 2 (ASR-DT2)	Setting range: 0.10~10.00 Sec.	Factory default: 1.00

The parameters are applied to adjust proportional gain of speed adjuster, integral time and differential coefficient. Each parameter should be set as following:

- 1) Proportional gain P: As value is bigger, the response is faster, however the stability of system is worse and overlarge gain can lead to revolution shock.
- 2) Integral time coefficient I: As value is greater, the response is faster, and the revolution over-adjusting is greater, while the stability is worse. In general, the parameters are direct proportional to system inertia. When inertia is great, the parameter also set with great value.
- 3) Differential coefficient D: it is the reverse to differential time constant; there is no need in general system and it should be set to be zero. Differential adjusting in reality is a kind of trend forecasting adjustment; the parameter set is bigger, the differential function is stronger. Proper differential set can fast the response speed, improve the stability, and it is used to the system with requirements of less inertia and fast response.
- 4) Differential output filtering time constant DT: Differential output to the adjuster for a stage of inertia filtering time constant is generally set direct proportion to system inertia.

F8.1.29 Adjuster output upper limit amplitude (transient positive torque limit)	Setting range: 0.0~250.0(%)	Factory default: 200.0
F8.1.30 Adjuster output lower limit amplitude (transient negative torque limit)	Setting range: -250.0~0.0(%)	Factory default: -200.0

The parameter is applied to set adjuster output amplitude and limit system's transient forward and backward torque. Its set value is the percentage corresponding to rated torque.



Actual output torque is also limited by adjuster output lower limit amplitude [F1.4.47] and should pick up the lower among the two. When running acceleration and deceleration, it is mainly limited by electricity limit level.

7.32 Protective parameters (Group F8.2)

F8.2.32 Excessive action of revolution deviation (DEV)	Setting range: 0~3	Factory default: 0
F8.2.33 Over speed (OS) detection action	Setting range: 0~3	Factory default: 1

The parameter is used to set excessive action of revolution deviation (DEV) and over speed (OS) detection action.

0: No action

Inverter keeps on running without reporting any fault or warning message.

1: Alarm free stop

Inverter immediately blockades output and reports overlarge deviation of rotating speed of **Fu.018 (DEV)/Fu.019** over-speed fault, while electric motor freely coasts to stop

2: Alarm deceleration stop

Inverter slows down to stop according to effective time of deceleration, and reports overlarge deviation of rotating speed (**Fu.018**) or over-speed (**OS**) fault (**Fu.019**).

3: Alarm continuing running

Inverter keeps on running, whereas **reports** overlarge deviation of rotating speed (**aL.018**) or overspeed (**OS**) warning (**aL.019**) at the same time.

F8.2.34 Detected value of excessive revolution deviation (DEV)	Setting range: 0.0~50.0(%)	Factory default: 20.0(%)
F8.2.35 Detection time of excessive revolution deviation (DEV)	Setting range: 0.0~10.00Sec.	Factory default: 10.00

These parameters are used to set detecting value and time for overlarge deviation of rotating speed (**DEV**).

Provided that deviation of rotating speed is continuously greater than given **DEV** detecting value within given **DEV** detecting time [**F8.2.35**], then inverter shall be in line with the setting action of **F8.2.32**. Set value of **F8.2.34** is corresponding to the percentage of upper limit frequency [**F0.1.21**].

F8.2.36 Detected value of over speed (OS)	Setting range: 0.0~150.0(%)	Factory default: 120.0(%)
F8.2.37 Detection time of over speed (OS)	Setting range: 0.0~2.00Sec.	Factory default: 0.10

These parameters are used to set detecting value and time of over-speed (**OS**).

Provided that feedback rotating speed is continuously faster than given **OS** detecting value within given **OS** detecting time [**F8.2.37**], then inverter shall be in line with the setting action of **F8.2.33**. Set value of **F8.2.36** is corresponding to the percentage of upper limit frequency [**F0.1.21**].

7.33 Torque control (Group F8.3)

F8.3.40 Selection of torque command channel (instruction fetch direction)	Setting range: 0~12	Factory default: 0
--	----------------------------	---------------------------

0: Digital setting (F8.3.41)

Take the set value of **F8.3.41** as given value of torque, and conduct power failure storage.

1: Panel shuttle potentiometer setting

Set value of torque is given by rotational shuttle potentiometer

2: Analog input AI1

AI1 input voltage value of **0~10V** is corresponding to **0~300%** of rated torque

3: Analog input AI2

AI2 input current value of **4~20mA** is corresponding to **0~300%** of rated torque

4: Analog input AI3

AI3 input voltage value of **-10~10V** are corresponding to **0~300%** of rated torque

5: Analog input AI3 (bipolarity)

AI3 input voltage value of **-10~10V** is corresponding to **-300%~300%** of rated torque; positive and negative input of **AI3** are corresponding to positive and negative instruction value of torque.

6: Frequency signal input (Fin)

Maximum value of input frequency of **Fin** terminal is corresponding to **300%** of rated torque.

7: Process PID output

For process **PID** output that given as torque instruction, **F7.0.00** parameter needs to be set as **#1##** for matching.

8: Reserved

Default 0 revolution setting

9: MODBUS Fieldbus set value 1

Current torque instruction of inverter is set by principal computer through built-in standard **RS485** communication interface of inverter. It is the relative value of the maximum set torque.

10: MODBUS Fieldbus set value 2

Current torque instruction of inverter is set by principal computer through built-in standard **RS485** communication interface of inverter. It is the absolute value of the maximum set torque.

11: Virtual analog input SA1

12: Virtual analog input SA2

F8.3.41 Torque digital setting	Setting range: -250~250(%)	Factory default: 0.0
---------------------------------------	-----------------------------------	-----------------------------

Its set value, the setting with symbols (direction), is corresponding to the percentage of rated torque; actual given direction of torque is "Exclusive OR" of control command direction and set value direction.

7.34 MODBUS fieldbus (Standard expansion card configuration) (Group FA.0)

FA.0.02 Local station address	Setting range: 0~247	Factory default: 1
--------------------------------------	-----------------------------	---------------------------

This parameter is used to set the address of the local inverter in the case of serial port communication. It is only effective when the inverter is a slave one. During communication, the local device only receives commands for the data frames consistent with the address of this device, and then sends back response frames.

	<p>0 is the broadcasting address. When it is set to the broadcasting address, the device will only receive and execute broadcasting commands of the master device and will not respond to the master device.</p>
---	--

FA.0.03 Local inverter response delay	Setting range: 0~1000mS	Factory default: 5 mS
--	--------------------------------	------------------------------

The response delay of the inverter refers to the waiting time since the inverter serial port has received and explained the command sent from the slave device till the response frames are sent.

FA.0.04 Communication failure judging time	Setting range: 0.01~10.00Sec.	Factory default: 1.00
---	--------------------------------------	------------------------------

If the local inverter has not received correct data signal beyond the time interval defined by this parameter, then the communication is judged to be failed for the local inverter. The inverter will report **Fu.071** fault, and will act as set by **FA.0.05**.

7.35 Mapping parameter access (Group FA.1)

FA.1.08~FA.1.13 Mapping application parameter 1~6 (H)	Setting range: F0.00~FF.55	Factory default: F0.29/ F0.32
FA.1.14~FA.1.23 Mapping status parameter 1~10 (H)	Setting range: d0.00~d1.49	Factory default: d0.00~d0.09

When A350 series inverter makes access to functional parameters or monitoring parameters via the bus, corresponding address can be predicted directly with the functional code (*refer to Chapter 10. Description of Communication Protocols*). However, when it is needed to access multiple functional parameters or monitoring parameters with discontinuous address, multiple-frame data are needed in this method.

The mapping parameter access is actually a needle access mode. When accessing (reading or writing) several functional parameters or status parameters with discontinuous address, these parameters can be mapped into an area with continuous address (bus-control parameter area) for accessing.

See the following table for the bus-control parameters of V350 series inverters.

Register Name	Access address	Remarks
Control word	0x1300	Can be read as per the loops (1~16)
Set value 1	0x1301	Setting of relative values
Set value 2	0x1302	Setting of absolute values
Mapping application parameter 1	0x1303	The access parameter is set by FA.1.08.
Mapping application parameter 2	0x1304	The access parameter is set by FA.1.09.
Mapping application parameter 3	0x1305	The access parameter is set by FA.1.10
Mapping application parameter 4	0x1306	The access parameter is set by FA.1.11.
Mapping application parameter 5	0x1307	The access parameter is set by FA.1.12.
Mapping application parameter 6	0x1308	The access parameter is set by FA.1.13.
Status word	0x1309	Can be read as per the discrete quantity (1~16)
Mapping status parameter 1	0x130A	The access parameter is set by FA.1.14.
Mapping status parameter 2	0x130B	The access parameter is set by FA.1.15.
Mapping status parameter 3	0x130C	The access parameter is set by FA.1.16.
Mapping status parameter 4	0x130D	The access parameter is set by FA.1.17.
Mapping status parameter 5	0x130E	The access parameter is set by FA.1.18.
Mapping status parameter 6	0x130F	The access parameter is set by FA.1.19.
Mapping status parameter 7	0x1310	The access parameter is set by FA.1.20.
Mapping status parameter 8	0x1311	The access parameter is set by FA.1.21.
Mapping status parameter 9	0x1312	The access parameter is set by FA.1.22.
Mapping status parameter 10	0x1313	The access parameter is set by FA.1.23.

The mapping parameters are determined by **FA.1** group of parameters.

For example, in one frame of standard **MODBUS** protocol data, it's impossible to read the status parameters **d0.0.02**, **d0.0.05**, **d1.0.01** and **d1.1.31** and status word once and for all with a common method. To map status parameters into the bus-controlled parameter area with continuous address, set with the following method:

[FA.1.14]=d0.02

[FA.1.15]=d0.05

[FA.1.16]=d1.01

[FA.1.17]=d1.31

Then you it just needs to read the data in the continuous address **0x130A ~ 0x130D**.

7.36 Communication linkage synchronous control (Group FA.2)

FA.2.26 Linkage setting proportion coefficient	Setting range: 0.010~10.000	Factory default: 1.000
---	------------------------------------	-------------------------------

This parameter can correct the proportion of the set value received from the communication port. During linkage control, this parameter defines the proportion between the output frequency of the master machine and the slave machine.

FA.2.27 Fine adjustment source for linkage proportion coefficient	Setting range: 0~3	Factory default: 0
--	---------------------------	---------------------------

0: No fine adjustment

If the fine adjustment source for linkage proportion coefficient is void, then:

Slave frequency command = master frequency command * [FA.2.26] of the slave machine.

1: Analog input AI1

If **AI1** is selected for the fine adjustment source for linkage proportion coefficient, then:

Slave frequency command = master frequency command * [FA.2.26] of the slave machine * **AI1/AI1** maximum.

2: Analog input AI2

If **AI2** is selected for the fine adjustment source for linkage proportion coefficient, then:

Slave frequency command = master frequency command * [FA.2.26] of the slave machine * **AI2/AI2** maximum.

3: Analog input AI3

If **AI3** is selected for the fine adjustment source for linkage proportion coefficient, then:

Slave frequency command = master frequency command * [FA.2.26] of the slave machine * **AI3/AI3** maximum.

FA.2.28 Slave machine offset frequency/revolution	Setting range: 0, 1, 2	Factory default: 0
--	-------------------------------	---------------------------

This parameter of the master inverter does not function, and it is used to select the auxiliary frequency of the slave machine:

Actual output frequency of the slave machine = master machine frequency command * slave machine linkage proportion (including fine adjustment) + offset frequency

0: No offset

No offset frequency/revolution; the frequency set value of the slave machine is determined by the frequency command of the master device and the setting of **FA.2.26** and **FA.2.27**.

1: Determined by frequency setting source 1

The frequency set value of the slave machine frequency setting source 1 is regarded as the offset frequency/revolution of the slave machine.

2: Determined by frequency setting source 2

The frequency set value of the slave machine frequency setting source 2 is regarded as the offset frequency/revolution of the slave machine.

FA.2.29 Linkage balance function	Setting range: 0~3	Factory default: 0
---	---------------------------	---------------------------

0: Void

1: Current balance

With reference to the load current of the master device, each slave device will automatically conduct fine adjustment to the output of local device so as to keep consistency with the master device's current.

2. Torque balance

With reference to the torque of the master device, each slave device will automatically conduct fine adjustment to the output of local device so as to keep consistency with the master device's torque.

3: Power balance

With reference to the power of the master device, each slave device will automatically conduct fine adjustment to the output of local device so as to keep consistency with the master device's torque.

FA.2.30 Linkage balancing gain	Setting range: 0.001~10.000	Factory default: 1.000
---------------------------------------	------------------------------------	-------------------------------

When the linkage balancing function is effective, this parameter is used to set the adjusting gain output by this device, and it is only effective for the slave device. The higher the gain is, the higher the amplitude of the self-balancing adjustment is.

7.37 Zero-speed torque and position control (Fb.2 group)

Fb.2.18 Automatic shift frequency	Setting range: 0.0~5.00Hz	Factory default: 1.00
Fb.2.19 Automatic shift switching cycle	Setting range: 0.10 ~ 2.00Sec.	Factory default: 0.30

Combined with the multifunctional input terminal (Function No. 67), it is especially used for transmission machineries with mechanical shifting function (e.g. machine tool spindle drive). This parameter is used to set the operating frequency and FWD and REV shift cycle when the function is valid.

Fb.2.20 Zero frequency torque holdup (DC bind-type brake preferred)	Setting range: 0~ 2	Factory default: 0
--	----------------------------	---------------------------

This parameter is to set the bind-type brake function at 0 speed. When it is set to 1, the actions on DC are completely identical. The electronic bind-type brake at that time can ensure the motor completely not rotating under the drag of load.

In the VC control mode with PG feedback, if it is set to 2, the equipment will output 0 speed torque in the mode of position locking. Even if it is dragged by loads, the motor axis will not rotate.

Fb.2.21 position locking gain1	Setting range: 0.01 ~ 10.00	Factory default: 1.00
---------------------------------------	------------------------------------	------------------------------

When the zero-frequency torque is kept at 2, this parameter is used to set the gains between the motor output torque and the axis deviation. The larger the number is, the higher the 0 speed torque is. If the value is too high, 0 speed ventilation may be resulted in.

7.38 Virtual input and output (group FF.0)

FF.0.00 FF configuration parameter locking (H)	Setting range: 0000~1001	Factory default: 0000
---	---------------------------------	------------------------------

FF group parameters include special and internal function parameters, and their setting and initialization are confined. This group of parameters is used to set the user's authority for operating FF parameters.

FF.0.01~FF.0.08 Definition of virtual output node (SDO1~ SDO8)	Setting range: 0~71	Factory default: 0
---	----------------------------	---------------------------

The virtual output nodes **SDO1~SDO8** are functionally the same as the multifunctional output terminals **DO1~DO3**, but do not output any signal. They are directly connected in the controller of the inverter to the virtual input nodes **SDI1~SDI8** one to one.

Using virtual nodes can not only help simplify wiring but can also avoid interference. The function of **SDO1~SDO8** can be defined by setting the value of FF.0.01~FF.0.08. Please refer to Table 2 (Comparison Table for Variables of Multifunctional Output Terminals (DO/EDO/SDO) for the variables corresponding to the set value.

FF.0.09~FF.0.16 Definition of virtual input node (SDI1~ SDI8)	Setting range: 0~96	Factory default: 0
--	----------------------------	---------------------------

The virtual input nodes **SDI1~SDI8** are functionally the same as the multifunctional input terminals **DI1~DI9**. But there are no actual physical input nodes. They are connected to the virtual output **SDO1~SDO8** one to one, and are directly taken from the virtual output signal.

The virtual input nodes **SDI1~SDI8** are functionally programmable, and their function can be defined by setting the values of FF.0.09~FF.0.16. Please refer to Table 1 (Comparison Table for Functions of Multifunctional Terminals (DI/EDI/SDI) for functions corresponding to the set value.

FF.0.17 Virtual output - input connection polarity (H)	Setting range: 0000~1111	Factory default: 0000
FF.0.18 Virtual output - input connection polarity (H)	Setting range: 0000~1111	Factory default: 0000

The parameters are used to set the connection logic status of the virtual output nodes **SDO1~SDO8** and virtual input nodes **SDI1~SDI8**. When it is set to be reverse polarity connection, the virtual output signal will be negated before being inputted to the virtual input port, as shown in Figure 7-59.

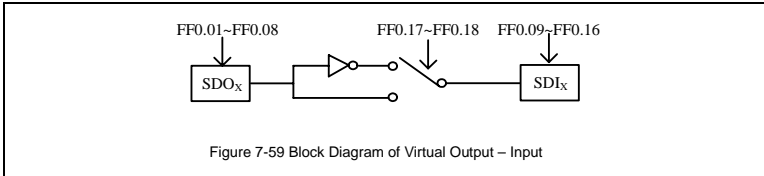

7.39 Protecting function configuration parameters (FF.1 group)

This group of parameters is used to define if the protecting function needs to be activated or not. Generally no modification is required.

7.40 Correction parameters (FF.2 group)

FF.2.25 AI1 Zero offset adjustment	Setting range: -0.500~0.500V	Factory default: 0.0
FF.2.26 AI1 gain correction	Setting range: 0.950~1.050	Factory default: 1.000

This group of parameters is used to make fine adjustment to **AI1** zero point and **AI1**. The relationship before and after adjustment:

$$AI1 \text{ input value} = AI1 \text{ gain correction} * AI1 \text{ value before adjustment} + AI1 \text{ zero offset.}$$

FF.2.27 4mA deviation adjustment for AI2	Setting range: -0.500~0.500mA	Factory default: 0.0
FF.2.28 AI2 gain correction	Setting range: 0.950~1.050	Factory default: 1.000
FF.2.29 AI3 Zero offset adjustment	Setting range: -0.500~0.500V	Factory default: 0.0
FF.2.30 AI3 gain correction	Setting range: 0.950~1.050	Factory default: 1.000
FF.2.31 AO1 zero offset correction	Setting range: -0.500~0.500V	Factory default: 0.0
FF.2.32 AO1 gain correction	Setting range: 0.950~1.050	Factory default: 1.000
FF.2.33 AO2 zero offset correctio	Setting range: -0.500~0.500V	Factory default: 0.0
FF.2.34 AO2 gain correction	Setting range: 0.950~1.050	Factory default: 1.000

The correction principle for each analog input/output port is the same as **AI1**. The relationship curves with zero offset adjustment and gain correction are respectively as below. Generally, users do not need to set these parameters.

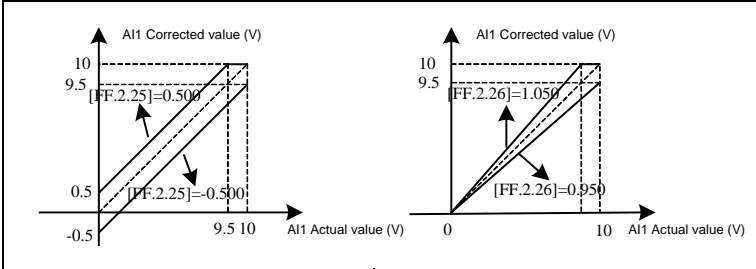

Figure 7-60-A AI1 Zero Offset Correction Curve

Figure 7-60-B AI1 Gain Correction Curve

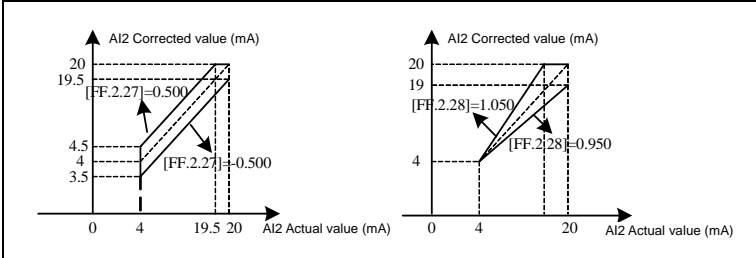

Figure 7-61-A AI2 Zero Offset Correction Curve

Figure 7-61-B AI2 Gain Correction Curve

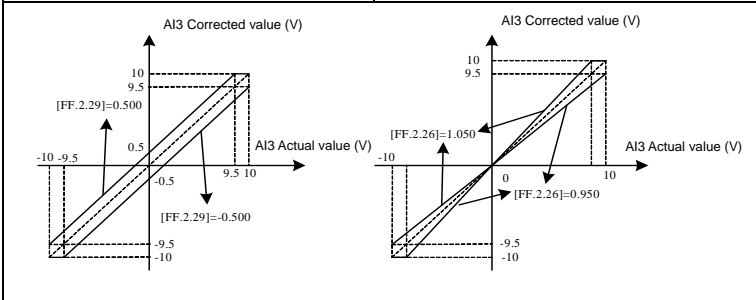
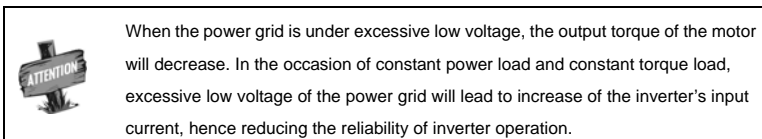

Figure 7-62-A AI3 Zero Offset Correction Curve

Figure 7-62-B AI3 Gain Correction Curve

FF.2.35 Undervoltage protection action level	Setting range: 320~450V	Factory default: 320V
---	--------------------------------	------------------------------

This parameter sets the allowable lower limiting voltage at the DC side during normal operation of the inverter. For some occasions with lower power grid, it is applicable to appropriately reduce the undervoltage protection level, so as to ensure normal operation of the inverter.



The set value for this parameter [FF.2.35] must be no more than the undervoltage adjustment action level [F1.4.45].

FF.2.36 Correction coefficient of DC side voltage detection value	Setting range: 0.950~1.050	Factory default: 1.000
--	-----------------------------------	-------------------------------

When the actual bus of the inverter is deviated from the value of the DC side voltage monitoring parameter **d0.0.07**, it is applicable to set this parameter combined with the correction of potentiometer in the bus voltage detection circuit.

7.41 Special functional parameters (FF.3 Group)

The modification of this group of parameters should be conducted under the guidance of professionals, and no modification is needed generally.

7.42 Other configuration parameters (Group FF.4)

FF.4.41 Cooling fan control	Setting range: 0000~0111	Factory default: 0101
------------------------------------	---------------------------------	------------------------------

The unit: Soft start function

This function helps effectively reducing the instantaneous power required for starting the fan, hence guarantee stable and reliable operation of the switch power supply.

Tens digit: Air volume auto adjustment

The revolution of the cooling fan can be automatically adjusted according to the ambient temperature and operation status of the inverter, so as to maximize service life of the cooling fan.

Hundreds' digit: Start time

0: Start immediately after power-on

The fan will run according to the settings in the unit and ten's digit of this parameter immediately after

the inverter is powered on.

1: Start during running

The fan will run according to the settings in the unit and ten's digit of this parameter after the inverter is powered on and has received the running command.

FF.4.42 Operating panel control options	Setting range: 0000~2001	Factory default: 0000
--	---------------------------------	------------------------------

Kilobit: Panel control selection (except STOP key)

0: Standard panel interface control (can be connected to monitoring panel via RS485)

The control command can only be given through the standard operating panel, and external monitoring panel can be connected via **RS485**.

1: RS485 port external panel control (the standard panel only for monitoring)

The control command can only be given via **RS485** port, and the standard panel is only used for monitoring.

2: Multifunctional terminal switching

The master control panel is selected by the multifunctional input terminal (function no. 40) and the terminal function is set with the parameters **F3.0.00~ F3.0.08**.

FF.4.43 Special function configuration (H)	Setting range: 0000~1111	Factory default: 0101
---	---------------------------------	------------------------------

The unit: Motor parameter identification auto-start

0: Forbidden

1: Permitted

After modifying the motor nameplate parameters, the inverter will automatically set static self identification of motor parameters once.

Tens digit: Voltage vector composition mode

0: Three-phase composition

1: Two-phase composition

Another modulation method for space voltage vector. This method can help appropriately reduce heating of the inverter, but audio noise may somewhat increase.

Hundred's digit: Small pulse shielding

0: Void

1: Effective

thousand:reserved

Chapter 8

Warning, Alarm Diagnosis And Countermeasures

When the frequency inverter sends warning signals, the auxiliary display column displays warning code. Some warnings have no influence on the operation of the inverter. Those warnings which may influence the operation of the frequency inverter should be eliminated as much as possible; otherwise, more serious faults may be caused. When the frequency inverter fails to alarm, its protective function will act and display fault code and the inverter will stop outputting with the motor freely sliding and shutting down.

8.1 Alarm display and troubleshooting

Display	Fault description	Possible causes	Solutions
Fu.001	Overcurrent during acceleration	<ol style="list-style-type: none"> 1. The acceleration time is too short. 2. V/F curve or torque boosting is set improperly. 3. After transient stop, the rotating motor is restarted. 4. The frequency inverter has smaller capacity. 5. The encoder is faulty or disconnected during the operation and acceleration with PG. 	<ol style="list-style-type: none"> 1. Adjust acceleration time 2. Adjust V/F curve or torque boosting parameters 3. Set the start/stop mode [F0.4.38] to the revolution tracking restart mode. 4. Select frequency inverter with matched capacity level. 5. Check encoder and its connection.
Fu.002	Overcurrent during deceleration	<ol style="list-style-type: none"> 1. The deceleration time is too short. 2. The potential energy load or load inertia is too large. 3. The frequency inverter has smaller capacity 4. The encoder is faulty or disconnected during the operation and deceleration with PG. 	<ol style="list-style-type: none"> 1. Adjust deceleration time. 2. Connect braking resistor or unit externally. 3. Select frequency inverter with matched capacity level. 4. Check encoder and its connection.

Display	Fault description	Possible causes	Solutions
Fu.003	Overcurrent during operation	<ol style="list-style-type: none"> 1. The load changes suddenly. 2. The grid has over-low voltage. 3. The frequency inverter has smaller capacity. 4. The load is overweight. 5. After transient stop, the rotating motor is restarted (at the time of start). 6. The three-phase output line of the frequency inverter has interphase short circuit or phase line short circuit to ground. 7. The encoder is suddenly disconnected during closed-loop high-speed operation. 	<ol style="list-style-type: none"> 1. Reduce load sudden change. 2. Check voltage of power supply. 3. Select frequency inverter with matched capacity level 4. Check load or replace with a frequency inverter with larger capacity 5. Set the start/stop mode [F0.4.38] to the revolution tracking restart mode. 6. Eliminate short circuit fault. 7. Check the encoder's wiring.
Fu.004	Overvoltage during acceleration	<ol style="list-style-type: none"> 1. The input voltage is abnormal. 2. The revolution closed loop parameters are set improperly during vector control operation. 3. The rotating motor is started (without revolution tracking). 	<ol style="list-style-type: none"> 1. Check input power supply. 2. Adjust revolution closed loop parameters, please refer to the description of F8.1 parameter set 3. Set the start/stop mode [F0.4.38] to the revolution tracking restart mode.
Fu.005	Overvoltage during deceleration	<ol style="list-style-type: none"> 1. The deceleration period is too short. 2. The load potential energy or inertia is too large. 3. The input voltage is abnormal. 	<ol style="list-style-type: none"> 1. Adjust deceleration time. 2. Connect braking resistor or unit externally. 3. Check input power supply.
Fu.006	Overvoltage during operation	<ol style="list-style-type: none"> 1. The input voltage is abnormal. 2. The parameters of regulator are set improperly during vector control operation. 	<ol style="list-style-type: none"> 1. Install input reactor 2. Adjust parameters of regulator; please refer to the description of parameter set in F8.1
Fu.007	Overvoltage when shutting down	The voltage of the power supply is abnormal	Check voltage of power supply
Fu.008	Undervoltage during operation (can be shielded)	<ol style="list-style-type: none"> 1. The voltage of the power supply is abnormal 2. Large load is started in the grid. 	<ol style="list-style-type: none"> 1. Check voltage of power supply 2. Supply power separately

Display	Fault description	Possible causes	Solutions
Fu.009	Drive protection action (can be shielded)	Main loop fault or interruption	<ol style="list-style-type: none"> 1. Check the main loop. 2. Shield this protection.
Fu.011	Electromagnetic interference	False operation caused by the surrounding electromagnetic interference.	Seek for technical service
Fu.012	Inverter overload	<ol style="list-style-type: none"> 1. The load is excessively high. 2. The acceleration period is too short. 3. The booster voltage of torque is too high or the V/F curve is set improperly 4. The grid voltage is too low. 5. The rotating motor is directly started when the function of revolution tracking restart is no activated. 6. In closed loop vector mode, the encoder is reversed. 	<ol style="list-style-type: none"> 1. Reduce load or replace with a frequency inverter with larger capacity. 2. Prolong acceleration time. 3. Reduce torque lifting voltage and adjust V/F curve. 4. Check the voltage of grid. 5. Set the start/stop mode [F0.4.38] to the revolution tracking restart mode. 6. Check whether the encoder is reverse.
Fu.013	Overload protection action of motor	<ol style="list-style-type: none"> 1. V/F curve is set improperly 2. The grid voltage is too low. 3. The motor has run for a long time with low speed and large load. 4. The overload protection coefficient of the motor is too small. 5. Locked-rotor operation of motor or overlarge load. 6. In closed loop vector mode, the encoder is reversed. 	<ol style="list-style-type: none"> 1. Adjust V/F curve. 2. Check the input grid voltage. 3. Select special frequency-variable \for long-term low speed operation. 4. Increase the overload protection coefficient of the motor ([F2.0.25]). 5. Adjust the working conditions of the load or select frequency inverter with matched capacity level. 6. Adjust the connection of encoder or change the function setting for direction of the encoder.
Fu.014	Overheating of frequency inverter	<ol style="list-style-type: none"> 1. The air duct is blocked. 2. The ambient temperature is over high. 3. The fan is abnormal. 4. The temperature detecting circuit or power module is abnormal. 	<ol style="list-style-type: none"> 1. Clean the air duct or improve ventilation conditions. 2. Improve ventilation conditions and reduce carrier frequency. 3. Replace the fan. 4. Seek for the manufacturer's support.

Display	Fault description	Possible causes	Solutions
Fu.017	External equipment is faulty or the panel has forced stoppage	The external equipment of the frequency inverter is faulty, the input terminal has signal input	Check signal source and relevant equipment and find the root leading to the stoppage of the panel.
Fu.018	Excessive protection of revolution deviation (DEV)	<ol style="list-style-type: none"> 1. The load is too large. 2. The acceleration time is too short. 3. The load is locked. 4. The detection value ([F8.2.34]) and time ([F8.2.35]) for DEV is set improperly. 	<ol style="list-style-type: none"> 1. Reduce load 2. Prolong acceleration and deceleration time. 3. Confirm the mechanical system of the load 4. Reset the detection value ([F8.2.34]) and time ([F8.2.35]) for DEV.
Fu.019	Over speed fault (OS)	<ol style="list-style-type: none"> 1. Overshoot or undershoot. 2. The frequency is too high. 3. The overspeed detection value ([F8.2.36]) and the overspeed time ([F8.2.37]) is set improperly. 	<ol style="list-style-type: none"> 1. Adjust the gain 2. Adjust the set value of frequency 3. Reset the set value of the detection value ([F8.2.36]) and time ([F8.2.37]) of OS.
Fu.020	Reverse connection of A, B pulse	The A-phase and B-phase pulses on PG card are connected in wrong sequence.	<ol style="list-style-type: none"> 1. Change the connection order of A, B pulse, or, 2. Modify the setting of parameter F8.0.06, or, 3. Adjust phase sequence of output U, V, W.
Fu.021	The main loop contactor does not act properly.	The main loop contactor does not contact well.	Replace the main loop contactor.
Fu.022	Internal data memory is faulty	<ol style="list-style-type: none"> 1. There is intense noise around in the process of writing in function code data 2. The internal memory is damaged 	<ol style="list-style-type: none"> 1. Retry after reset 2. Seek for manufacturer's service

Display	Fault description	Possible causes	Solutions
Fu.026 Fu.027 Fu.028	The output current of U phase is deficient/smaller. The output current of V phase is deficient/smaller. The output current of W phase is deficient/smaller	1. The lead from frequency inverter to motor is disconnected. 2. The driving or control panel of the frequency inverter is faulty 3. The three-phase winding of the motor is faulty	1. Eliminate peripheral faults. 2. Seek for manufacturer's support. 3. Eliminate motor faults.
Fu.032	The three-phase input voltage is unbalanced (can be shielded)	The imbalance rate of three-phase voltage is larger.	1. Add AC or DC reactor 2. Increase the capacity of frequency inverter
Fu.036 Fu.037 Fu.038	AI1 input disconnection. AI2 input disconnection. AI3 input disconnection.	1. The wiring of input analog signal is disconnected or analog input signal source is inexistent. 2. Parameters related to disconnection detection are configured improperly.	1. Check the wiring of analog input signal and the analog input signal source 2. Modify the configuration parameters
Fu.039	Fin input is disconnected	1. The wiring of pulse input signal is disconnected or analog input signal source is inexistent. 2. Parameters related to disconnection detection are configured improperly.	1. Check the wiring of pulse input signal and analog input signal source 2. Modify the configuration parameters
Fu.040	The revolution detection loop is disconnected	1. The speed measuring module is incorrectly connected. 2. The wiring of speed measuring module is disconnected. 3. The output of speed measuring module is abnormal. 4. Relevant function codes are set improperly.	1. Check the connection of speed measuring module. 2. Seek for manufacturer's support.

Display	Fault description	Possible causes	Solutions
Fu. 041	The motor fails to be connected when the motor parameters are identified.	The motor fails to be connected when the motor parameters are identified.	Connect the motor.
Fu.042	U phase output is disconnected or the parameters are seriously unbalanced	<ol style="list-style-type: none"> 1. The lead from frequency inverter to motor is disconnected. 2. The driving or control panel of the frequency inverter is faulty. 3. The three-phase winding of the motor is faulty. 	<ol style="list-style-type: none"> 1. Eliminate peripheral faults 2. Seek for manufacturer's support 3. Eliminate motor faults.
Fu.043	V phase output is disconnected or the parameters are seriously unbalanced	<ol style="list-style-type: none"> 1. The lead from frequency inverter to motor is disconnected. 2. The driving or control panel of the frequency inverter is faulty 3. The three-phase winding of the motor is faulty 	<ol style="list-style-type: none"> 1. Eliminate peripheral faults. 2. Seek for manufacturer's support 3. Eliminate the fault of motor.
Fu.044	W phase output is disconnected or the parameters are seriously unbalanced	<ol style="list-style-type: none"> 1. The lead from frequency inverter to motor is disconnected. 2. The driving or control panel of the frequency inverter is faulty. 3. The three-phase winding of the motor is faulty. 	<ol style="list-style-type: none"> 1. Eliminate peripheral faults. 2. Seek for manufacturer's support 3. Eliminate the fault of motor.
Fu.051	U phase current is detected faulty (sensor or circuit)	<ol style="list-style-type: none"> 1. The current sensor or circuit is damaged. 2. The auxiliary power supply is faulty. 3. The control and driving panel are improperly connected. 	Seek for manufacturer's support.
Fu.052	V phase current is detected faulty (sensor or circuit)	<ol style="list-style-type: none"> 1. The current sensor or circuit is damaged. 2. The auxiliary power supply is faulty. 3. The control and driving panel are Improperly connected. 	Seek for manufacturer's support.
Fu.054	The temperature sensor 1 is faulty (can be shielded)	The temperature detecting circuit is abnormal.	Seek for manufacturer's support

Display	Fault description	Possible causes	Solutions
Fu.067	The communication linkage of functional expansion unit 1 is abnormally disconnected.	1. The expansion board is not well contacted with the main control board. 2. The expansion board is damaged.	1. Reinstall the expansion board. 2. Replace with a new expansion board.
Fu.068	The communication linkage of functional expansion unit 2 is abnormally disconnected.	1. The expansion board is not well contacted with the main control board. 2. The expansion board is damaged.	1. Reinstall the expansion board. 2. Replace with a new expansion board.
Fu.072	The connection of accessories is abnormal		
Fu.201	Conflicting parameter setting		Please contact the direct supplier.
Fu.301~ Fu.311	Control panel is faulty		Seek for manufacturer's support.

8.2 Warning display and troubleshooting

Display	Warnings	Can be shielded or not	Solutions other than shielding
aL.003	Overhigh power supply voltage		Check input power supply
aL.008	Lower input voltage (undervoltage early warning)		Check input power supply
aL.011	Bad electromagnetic environment		Improve working environment or seek for manufacturer's support
aL.012	The load is excessively high and protection may be occurred.		Reduce load, or replace a frequency inverter with larger power
aL.014	INV overheating early warning		Improve ventilation conditions and reduce carrier
aL.018	Overlarge DEV		<ol style="list-style-type: none"> 1. Reduce load 2. Prolong acceleration and deceleration time 3. Confirm mechanical system of load 4. Confirm the detection value ([F8.2.34]) and time ([F8.2.35]) for DEV
aL.019	Over speed (OS)		<ol style="list-style-type: none"> 1. Adjust frequency setting loop 2. Check the setting value of detection value [F8.2.36]) and time ([F8.2.37]) for OS
aL.026 aL.027 aL.028	<p>The output current of U phase is deficient/smaller</p> <p>The output current of V phase is deficient/smaller</p> <p>The output current of W phase is deficient/smaller</p>	Can be shielded	Check the connecting wire between frequency inverter and motor or the winding of motor
aL.031	The starting enabling signal is deficient		<ol style="list-style-type: none"> 1. Check the enabling connection (42) in multifunctional input terminal and the status of the terminal (ON/OFF) 2. Check whether the starting enabling signal in bus command word is effective or not
aL.032	Early warning of unbalanced three-phase input voltage	Can be shielded	Measure the input voltage of all the phases, install ACR and reduce imbalance rate among phases

Display	Warnings	Can be shielded or not	Solutions other than shielding
aL.036 aL.037 aL.038	A11 input is disconnected A12 input is disconnected A13 input is disconnected	Can be shielded	1. Check the connection of analog input signal 2. Check whether there're signals in the signal source
aL.039	Fin input is disconnected (retained)		
aL.040	The revolution detecting loop is disconnected		1. Check the connection of speed measuring module 2. Seek for manufacturer's support
aL.041	No-load operation fails to identify the parameters of motor		
aL.042 aL.043 aL.044	The parameters of U phase of motor is abnormal The parameters of V phase of motor is abnormal The parameters of W phase of motor is abnormal		Check whether the winding of motor is faulty
aL.045	Over temperature of motor		Select special motor for frequency conversion for long-term low speed operation
aL.049	The driving circuit is abnormal and unbalanced		
aL.054	The temperature sensor is faulty	Can be shielded	Replace the temperature sensor.
aL.058	The parameters can not be recovered in batch during operation		
aL.059	The numerical value when energized can not be recovered during operation		
aL.061	The connection between expanded communication module and master control board is interrupted abnormally		
aL.062	The function expansion unit 1 has a hardware conflict		1. The expansion unit selected is inappropriate and can not be used with such type of frequency inverter 2. The function expansion unit has a internal fault

Display	Warnings	Can be shielded or not	Solutions other than shielding
aL.063	The function expansion unit 2 has a hardware conflict		1. The expansion unit selected is inappropriate and can not be used with such type of frequency inverter 2. The function expansion unit has a internal fault
aL.064	The function expansion unit has a resource conflict		This expansion unit can not be used with other expansion units
aL.065	Fail to establish communications with function expansion unit 1		
aL.066	Fail to establish communications with function expansion unit 2		
aL.067	The communication links of function expansion unit 1 is interrupted abnormally		
aL.068	The communication links of function expansion unit 2 is interrupted abnormally		
aL.071	The parameter download is failed (note: download is from operation panel to control panel of frequency inverter; upload is from control panel to operation panel)		Check whether the communication interface between operation panel and control panel is normal or not
aL.072	The memory of panel fails to be operated		
aL.073	The memory of panel inhibits write and can not download parameters		
aL.074	The upload of parameters is failed (automatically recover to the numerical value before uploading)		1. Check whether the communication interface between panel and control panel is normal or not. 2. In the parameter F0.0.08, parameter upload is forbidden in terms of local upload.
aL.075	The version of panel parameters is different from that of equipment parameters; it can not be uploaded		Re-upload panel parameters same as the version of equipment parameters

Display	Warnings	Can be shielded or not	Solutions other than shielding
aL.076	The panel has no effective parameters and can not be uploaded		The panel parameters are not modified effectively and need not to be uploaded
aL.077	The panel parameters exceed the setting scope INV allowed and fail to be uploaded		Confirm the allowed parameter scope, reset and upload
aL.099	The operation panel is abnormally connected		After power off, reinsert and pull out of the panel or replace the panel
aL.100	The control program is failed resulted from electromagnetic interference		Improve electromagnetic environment
aL.103	The setting motor parameters are conflicted (rated frequency, revolution conflict)		Reset the motor parameters
aL.104	The setting motor parameters are conflicted (no-load current, rated current, rated revolution, rated frequency and rotor time constant)		Reset the motor parameters
aL.105	The inductance parameters of motor stator overflow (the motor parameter is incorrectly set)		Reset the inductance parameters of motors stator
aL.201	The setting parameters are conflicted and it's about to shut down		Immediately contact the direct supplier

Chapter 9 Care And Maintenance

Subjecting to influence of many factors such as temperature, humidity, dust, vibration as well as internal components aging, the inverter has potential risk of faults. In order to ensure long and steady operation of the system, regular care and maintenance must be conducted.

After long-distance transportation of the frequency inverter, users should check whether the components are in good condition, or the screws are fastened before use them. During the normal use period, users shall regularly clean the internal dust of frequency inverter and check whether the screws are loose.

Due to the high voltage of frequency inverter in service, the wrong operation can result in serious injury or death, therefore, the power supply of the frequency inverter shall be cut off, and the maintenance operation after ten minutes after the nixie tube of the frequency inverter panel extinguishing can be carried out.

9.1 Routine care and maintenance

Through routine maintenance, all kinds of abnormal condition and abnormal cause can be found promptly, and the faults and hidden dangers can be eliminated as soon as possible. Thus, the normal operation of equipment can be warrantyd and also the service life of the frequency inverter can be prolonged. Refer to the following table for routine maintenance.

Object checked	Inspection cycle		Scope of inspection	Assessment criterion
	Irregularly	Regularly		
Operation environment	√		1. Humidity, temperature 2. Dust, moisture 3. Gas	1. Open the frequency inverter when the temperature is above 45°C, keep humidity below 95%, without frost deposit 2. Free from peculiar odor, inflammable and explosive gas
Cooling system		√	1. Installation environment 2. Frequency inverter fan	1. The installation environment shall be well ventilated and the duct has no block 2. Fan is in well operation and without abnormal noise
Frequency inverter	√		1. Vibration, temperature rise 2. Noise 3. Wire, terminal	1. Vibration is smooth and outlet temperature is normal 2. No abnormal noise and no peculiar smell 3. No loose for fastening screw
Generator	√		1. Vibration, temperature rise 2. Noise	1. Smooth operation and normal temperature 2. No abnormalities and inconsistent noise
Input or output	√		1. Input voltage 2. Output current	1. The input voltage is in the specified scope 2. Output current is below the rated value

9.2 Inspection and displacement of the vulnerable components

During operation, some components of frequency inverter may wear or the performance is slowed down. In order to ensure the stable reliable operation of frequency inverter, the users shall carry out preventative maintenance for frequency inverter, and replace the components when necessary.

9.2.1 Filter capacitor

1. Possible cause of damage: Environmental temperature and the pulsating current are high, and electrolyte is aging.
2. Assessment criterion: When frequency inverter operate with load, users check whether there occur fault such as over current, over voltage; whether liquid leaks out, whether the relief valve bulge; whether the determination of electrostatic capacitive and insulation resistance are abnormal.
3. The pulsating current of main loop would affect the performance of the aluminum electrolysis filter capacitor, and the degree of influence depends on the environment temperature and the using conditions. Replace electrolytic capacitors of frequency inverter every three to four years under normal conditions.
4. Filter capacitor shall be replaced immediately if any of the following occurs: electrolyte of the electrolyte capacitor leaks, relief valve emits out, and subject of the capacitor expands.

9.2.2 Cooling fan

1. Possible cause of damage: Bearing wearing, leaf aging, etc.
2. Assessment criterion: When the power of frequency inverter is cut out, check the fan blades and other parts to see whether there is any abnormality such as crack. With the power on, just check whether the fan operation situation is normal, and whether it has abnormal vibration and noise.
3. Service life of the entire cooling fan in frequency converter is about 15000 hours (i.e. frequency inverter use continuously for about two years), if the fan has unusual voice or vibration, it should be replaced immediately.

9.3 Storage

After purchase of the frequency inverter, if the frequency inverter will be spared for a while or stored for a long time, users shall pay attention to the following items:

- Storage environment should comply with the following table:

Environmental Characteristics	Requirements	Remarks
Ambient temperature	-10℃~45℃	Long-term storage temperature is no more than 45℃, so as to avoid the degradation of capacitance characteristics. It shall avoid condensation and frozen environment caused by sudden change of temperature.
Relative humidity	5~95%	It can adopt measurement like plastic film sealing and desiccant.
Storage environment	Free from direct sunlight, no dust, no corrosive, no combustible gas, no oil, no steam, no gas, no drip, no vibration, and with little salt	

- If the frequency inverter is not in use for a long time, the current shall be applied to restore filter capacitor characteristics every half year, and at the same time other features of the frequency converter shall also be checked. When the current is applied, it shall increase the voltage gradually through autotransformer, and the conduction time should be above half an hour.

9.4 Warranty

If the frequency inverter body has the following cases, the company will provide warranty service:

- If faults or damages occur in normal use condition within the warranty period (within 18 months from the date of purchase), our company will provide free maintenance. Our company will charge a reasonable cost of maintenance when the warranty period has expired (more than 18 months).
- Even in the warranty period, if any fault is caused by the following cases, our company will charge certain amount of maintenance cost:
 - ① Fault due to that the users do not operate the device according to the operation manual or beyond the standard;
 - ② Fault due to random repair and modification without permission;
 - ③ Fault caused by poor preservation;
 - ④ Fault caused by improper use of the inverter for unintended purposes;
 - ⑤ Damage to the machine due to fire, corrosive salt, gas corrosion, earthquake, storms, floods, thunder, abnormal voltage or other force majeure.
- The company will provide lifelong paid maintenance services even the warranty period expires.

Chapter 10

Description Of Communication Protocol

10.1 Protocol overview

10.2 Interface and transmission method

Terminal Identifier	Terminal Usage	Function
RS+	Data Transceiving Terminal(+)	When connected to PC/PLC via RS 485 communication interface, connect to (+) signal
RS-	Data Transceiving Terminal(-)	When connected to PC/PLC via RS 485 communication interface, connect to (-) signal

10.3 Data structure

Modbus protocol is a universal protocol used in the industrial control unit. Because this protocol can be conveniently applied, it has been considered as the general industry standard and is widely applied to the integrated system of master controllers and slave units. By applying this protocol, units of various brands can be connected together and functioning as an industrial network.

Modbus defines 3 types of transmission modes: ASCII, RTU and TCP. A510 Frequency inverter only supports RTU mode.

V350 utilizes RS485 (RS232, optional, which has to be converted by a level) as the physical interface for Modbus, and one host can control one or more (maximum 247 units) frequency inverters.

By applying the asynchronous serial half-duplex transmission method, only master unit or slave unit can transmit data at one particular moment, and the other unit can only receive data.

1) 4 Optional Data Transmission Formats

- ① 1 start bit, 8 data bits, 1 stop bit, without parity bit (factory setting)
- ② 1 start bit, 8 data bits, 1 stop bit, even parity
- ③ 1 start bit, 8 data bits, 1 stop bit, odd parity
- ④ 1 start bit, 8 data bits, 2 stop bit, without parity bit

2) Baud rate

Seven optional baud rates: 1200bps, 2400 bps, 4800 bps, 9600 bps, 19200 bps, 38400bps, 79600 bps

3) Communication rules

Starting interval between data frames is longer than 3.5 byte transmission cycle (standard),

but the minimum interval should not be shorter than 0.5 ms.

10.4 Parameter configuration for frequency inverters

FA.0.00 is a read-only parameter, and is used to display the status of the communication card connection and bus;

FA.0.01 = 00XX, unit bit is used to choose baud rate, and tens bit is used to choose data format;

FA.0.02 = X, choose the address of this station;

FA.0.03~ FA.0.06, configure supporting communication parameters; refer to functional parameter table for detailed functions.



X indicates that this bit can be any value in the allowed range.

10.5 Brief introduction of functions

The Modbus functional codes supported by V350 are listed below:

Function	Code (Hexadecimal)	Description of Functions
Read coil status	0x01	Read coil status by bit. Each bit for the control word is mapped to coil 1~15 respectively.
Read discrete input status	0x02	Read discrete input status. Each bit for the status word is mapped to coil 1~15 respectively.
Read multiple hold registers	0x03	Read multiple hold registers. It can read all the application parameters, status parameters, control words, status words and set values of A510.
Read multiple input registers	0x04	Read multiple input registers. The address for analog input register starts from 0x1200.
Enforce single coil	0x05	Perform writing action for a single output bit. Each bit for the control word is mapped to coil 1~16 respectively.
Write to a single hold register	0x06	Perform writing action for a single hold register. All the parameters, control words, status words and set values of A510 are mapped to the hold register.
Query for the anomaly status	0x07	Query for the anomaly status information. In A510, the fault information of the frequency inverter can be queried.

Function	Code (Hexadecimal)	Description of Functions
Fault diagnosis	0x08	Execute field diagnosis for the bus fault. Support the sub-codes, like querying (0x00), rebooting (0x01), monitoring (0x04) and zero-clearing(0x0A) etc.
Enforce multiple coils	0x0F	Perform writing action for multiple output bits respectively. Each bit for the control word is mapped to coil 1~16 respectively.
Write to multiple hold registers	0x10	Perform writing action for multiple hold registers. All the parameters, control words, status words and set values of A510 are also mapped to the hold register.
Read/write to multiple hold registers	0x17	This function equals to combining 0x03 and 0x10 into a new command.

10.6 Access address summary

V350	Access Address	Functional Codes Supported (Hexadecimal)
Control bit Multifunctional terminal output Relay output	(0x1000-0x1100)	0x01- Read coil status 0x05- Enforce single coil 0x0F- Enforce multiple coils
Multifunctional terminal input for status bit	Discrete input (0x1100-0x1200)	0x02- Read input status
Analog input	Input register (0x1200-0x1300)	0x04- Read input register
Application parameters, Status parameters, Control words, Status words, Set values, Mapping status parameters, Mapping application parameters	Hold registers (application parameter area, status parameter area, 0x1300-0x1400)	0x03- Read multiple registers 0x06- Write to a single register 0x10- Write to multiple registers 0x17- Read/write to multiple registers

For detailed address distribution, please refer to below section of Modbus detailed address-finding distribution.

10.7 Detailed modbus address-finding distribution

1) Coil Address Summary (0x1000-0x1100)

Relevant Modbus functional codes: 0x01 (read coil status), 0x05 (write to a single coil), 0x0F (write to multiple coils)

Register name	Function Description	Access Address
Control bit – Bit 0	Reserve	0x1000
Control bit – Bit 1	Operation Allowed 0: Operation banned 1: Operation allowed	0x1001
Control bit – Bit 2	Starting allowed 0: Starting banned 1: Starting allowed	0x1002
Control bit – Bit 3	Reserve	0x1003
Control bit – Bit 4	Operation instruction 0: Stop 1: Operation	0x1004
Control bit – Bit 5	Reserve	0x1005
Control bit – Bit 6	Emergency Stop 0: Invalid 1: Valid	0x1006
Control bit – Bit 7	Free slide stop 0: Invalid 1: Valid	0x1007
Control bit – Bit 8	Reserve	0x1008
Control bit – Bit 9	Reserve	0x1009
Control bit – Bit10	Reserve	0x100A
Control bit – Bit 11	Reserve	0x100B
Control bit – Bit12	Acceleration/deceleration banned 0: Allowed 1: Banned	0x100C
Control bit – Bit 13	Zero-clearing for integrator input 0: Invalid 1: Valid	0x100D
Control bit – Bit 14	Remote Control 0: Invalid 1: Valid	0x100E
Control bit – Bit 15	Fault Reset 0->1 Reset	0x100F
DO1	Multifunctional output terminal 1	0x1020
DO2	Multifunctional output terminal 2	0x1021
EDO1	Multifunctional output terminal 3 (expansion card)	0x1030
RO1	Multifunctional relay output 1	0x1040
ERO1	Multifunctional relay output 2 (expansion card)	0x1050
SDO1~SDO8	Virtual output 1~8	0x1060 ~ 0x1067
Reserve		0x1068~0x107F

2) Discrete Input Address Summary (0x1100 ~ 0x1200)

Relevant Modbus functional codes: 0x02 (read input status)

Register name	Function Description	Access Address
Status word – bit 0	Ready	0x1100
Status word – bit 1	Operation allowed	0x1101
Status word – bit 2	Starting allowed	0x1102
Status word – bit 3	Reserve	0x1103
Status word – bit 4	Operation status	0x1104
Status word – bit 5	Direction	0x1105
Status word – bit 6	Zero speed	0x1106
Status word – bit 7	Acceleration	0x1107
Status word – bit 8	Deceleration	0x1108
Status word – bit 9	Arrival	0x1109
Status word – bit 10	Reserve	0x110A
Status word – bit 11	Reserve	0x110B
Status word – bit 12	Instruction source	0x110C
Status word – bit 13	Command source	0x110D
Status word – bit 14	Warning	0x110E
Status word – bit 15	Fault	0x110F
DI1	Multifunctional input terminal 1	0x1120
DI2	Multifunctional input terminal 2	0x1121
DI3	Multifunctional input terminal 3	0x1122
DI4	Multifunctional input terminal 4	0x1123
DI5	Multifunctional input terminal 5	0x1124
DI6	Multifunctional input terminal 6	0x1125
EDI1	Multifunctional input terminal 7 (expansion card)	0x1130
EDI2	Multifunctional input terminal 8 (expansion card)	0x1131
EDI3	Multifunctional input terminal 9 (expansion card)	0x1132
Reserve		0x1133–0x1199

3) Input Register Address Summary (1200H ~ 1300H)

Relevant Modbus functional codes: 0x04 (read input register)

Register name	Function Description	Value Range	Access Address
AI1	Analog input value 1	0 ~ 4080	0x1200
AI2	Analog input value 2	0 ~ 4080	0x1201
AI3	Analog input value 3 (expansion card)	0 ~ 4080	0x1202
Fin	Pulse input value (expansion card)	0 ~ 4080	0x1203
Reserve			0x1204~0x1299

4) Hold Register Address Summary

Relevant Modbus functional codes: 0x03 (read multiple registers), x06 (write to single register), 0x10 (write to multiple registers), 0x17 (read/write to multiple registers).

① Application parameter address

The application parameter access address can be obtained from the parameter's identifier when ascertaining the access address, the method is to ignore the sub-class code in the identifier (following referred to as "****"); let's see an example, for parameter identifier: HH.*.DD (eg.F2.0.33), it will obtain HHDD directly (hexadecimal format), and the access address for F2.0.33 is: 0xF233H. Below attached is the table for respective conversion of access addresses:

Parameter identifier	RAM Access Address ^①	ROM Access Address
F0.#.00 ~ F0.#.55	0xF000~0xF055	0xE000~0xE055
*****
F9.#.00 ~ F9.#.55	0xF900~0xF955	0xE900~0xE955
FA.#.00 ~ FA.#.55	0xFA00~0xFA55	0xEA00~0xEA55
*****
FF.#.00 ~ FF.#.55	0xFF00~0xFF55	0xEF00~0xEF55
dE.#.00 ~ dE.#.55(read-only)	0xDE00~0xDE55	0xBE00~0xBE55
CF.#.00 ~ CF.#.55(restricted)	0xCF00~0xCF55	0xBF00~0xBF55

② Status parameter address (read-only): The address conversion method for status parameter is similar to that for application parameter. However, there is no ROM access address.

Parameter Identifier	RAM Access Address
d0.#.00 ~ d0.#.55	0xD000~0xD055
d1.#.00 ~ d1.#.55	0xD100~0xD155

③ Bus Controlling Parameter Address (1300H ~ 1400H)

Register Name	Value Range	Access Address
Control word (mapping coils 0-15) ^②	0 ~ 0xFFFF	0x1300
Modbus set value 1 (Relative Value) ^③	-10000 ~ 10000	0x1301
Modbus set value 2 (Absolute Value)	-30000 ~ 30000	0x1302
Mapping application parameter 1 ^④	[F0.00 ~ FF.55]	0x1303
Mapping application parameter 2	[F0.00 ~ FF.55]	0x1304
Mapping application parameter 3	[F0.00 ~ FF.55]	0x1305
Mapping application parameter 4	[F0.00 ~ FF.55]	0x1306
Mapping application parameter 5	[F0.00 ~ FF.55]	0x1307
Mapping application parameter 6	[F0.00 ~ FF.55]	0x1308
Status word (Mapping discrete range 0-15)	0 ~ 0xFFFF	0x1309
Mapping status parameter 1	[d0.00 ~ d1.49]	0x130A
Mapping status parameter 2	[d0.00 ~ d1.49]	0x130B
Mapping status parameter 3	[d0.00 ~ d1.49]	0x130C
Mapping status parameter 4	[d0.00 ~ d1.49]	0x130D
Mapping status parameter 5	[d0.00 ~ d1.49]	0x130E
Mapping status parameter 6	[d0.00 ~ d1.49]	0x130F
Mapping status parameter 7	[d0.00 ~ d1.49]	0x1310
Mapping status parameter 8	[d0.00 ~ d1.49]	0x1311
Mapping status parameter 9	[d0.00 ~ d1.49]	0x1312
Mapping status parameter 10	[d0.00 ~ d1.49]	0x1313
Reserve	Undefined	0x1314 ~ 0x 1400

Notes:

- ① If there is no need to keep the parameters permanently, it suffices to write the parameters to the RAM area. However, if the parameters have to be maintained permanently, it is required to write the parameter values into the ROM area. The service life of ROM area will be shortened if parameters are frequently written to the ROM area. If value F2.1.13 needs to be written and maintained permanently, the register address where it should be written to is 0xE213.
- ② When reading/writing control words, it can be achieved via reading/writing to the coil mapped to each bit of control words, and it can also be achieved via reading/writing to the hold register corresponding to the control words. Both methods can achieve identical results. If it is needed to set the value for operation allowed, we can set the value of the bit 1 for control word (address 0x1001) as 1 via functional code 05, we can also set the value of control word (address 0x1300) as 0x0002 via functional code 06. When reading the status words, the method is similar to that for reading/writing control words. It can be achieved via reading the discrete input mapped to each bit of status words, and it can also be achieved via reading the hold register corresponding to the status words. If we need to read the operation direction, we can read the status bit 5 (address 0x1105) via functional code 02, we can also read the status word (address 0x1309) via functional code 03.
- ③ When we need to access several application parameters or monitoring parameters of discrete addresses, we can first map these parameters to bus control parameter area, and then we access to that area instead. As a matter of fact, access for mapped parameters is a type of pointer access, and the mapping parameters can be set in the FA.1 parameter group.

5) Anomaly Status Information

Relevant Modbus functional code 0x07 (Query)

- The frequency inverter's fault warning status and code corresponding to each bit of the returned data
- Returned data – bit 7: 0 — No fault on frequency inverter, 1 — Fault on frequency inverter
- Returned data – bit 6: 0 — No warning on frequency inverter, 1 — Warning on frequency inverter
- Returned data – bit 5~0: each code of fault information corresponds to the identifier code following Fu in the fault code of the frequency inverter.
- Each code of warning information corresponds to the identifier code following AL in the warning code of the frequency inverter.
- If data 0x8C (10001100) is returned, it indicates that the fault code of the frequency inverter is Fu. 012; if data 0x64 (01100100) is returned, it indicates that warning code of the frequency inverter is AL.036.

6) Fault Diagnosis:

Relevant Modbus functional code 0x08 (Diagnosis)

Sub-function code list

Sub-function code	Function	Query Data	Response Data
00	Return the identical query data	Random	Image query data
01	Re-start communication option (restore the "listen only" status for 04 sub-code)	FF00/0000	FF00/0000
04	Enforce slave unit into "Listen Only" status and the slave unit will not reply; the failed slave unit can be removed from the communication chain.	0000	No reply
0A	Clear all calculators and diagnosing registers	0000	Image query data
0B	Return the number of bus information items (for slave unit, count from the last reset or after clearing)	0000	Total number of bus information items
0C	Return the number of bus communication faults (CRC error calculation)	0000	CRC error number
0D	Return the number of bus anomaly faults (data abnormality error)	0000	Number of anomaly data items
0E	Return the number of slave unit information items (corresponding with slave unit address or the broadcasting information)	0000	Number of valid data items

Chapter 11 EMC

11.1 CE

The product can be sold freely in the market of EEA (European Economic Area) with CE label, and to be ensured to meet other requirements as LVD and EMC.

11.2 Definition

EMC (Electromagnetic Compatibility) means the capacity of anti-interference for electric and electron equipments, and the product could not interfere other local equipments also. EMC rules are defined requirements of anti-interference for EU area.

- 1) 1st Environment: including power supply equipments of civil low voltage grid.
 - 2) 2nd Environment: including power supply equipments of non-civil low voltage grid.
- C1 Inverter: when rated power of electric transmission system is under 1000V, use in 1st environment.
 - C2 Inverter: when rated voltage of electric transmission system is under 1000V, it would be plug equipments or mobile equipments. When it uses in 1st environment, it should install and adjust by professional engineer.
 - C3 Inverter: when rated voltage of electric transmission system is under 1000V, it is suitable in 2nd environment, but not 1st environment.
 - C4 Inverter: when rated voltage of electric transmission system is not under 1000V or rated current is not lower than 400A, or it is suitable in complicated system of 2nd environment.

11.3 Obey Standard Order

11.3.1 Obey EMC Order

V350 Series meet the requirements of standard EN61800-3: 2004 C2, which is suitable in 1st and 2nd environment.

11.3.2 Obey LVD Order

V350 Series meet the requirements of standard EN 61800-2.

Installation of 1st environment:

- 1) Inverter chooses suited EMC filter.
- 2) Select suitable motor and wires.
- 3) Wiring according to 《Cable Wiring Requirements》.
- 4) Max output cable length is 100m.



Warning: If inverter is using in residence or civil area, it would cause electromagnetic interference. Except CE requirements, user should take some necessary action to avoid this interference.

11.4 Guidance of EMC External Accessories Installation and Selection

External EMC input filter between inverter and power supply is not only to restrain interference to inverter by ambient electromagnetic noise, and to avoid interference to ambient equipments by inverter. In order to meet standard of C2 level, it should add external suitable EMC filter on inverter input terminal.

11.4.1 Notice of EMI Input Filter Installation:

Please obey rated values for using the filter. Because filter is type I electrical equipment, filter metal shell should contact well with installation cabinet metal with good Conductive continuity. Otherwise, it would cause the risk of electric shock and affect EMC efficiency badly. The earth of filter and inverter PE terminal must earth on same GND. If not, it will affect EMC efficiency badly. Please contact our technical support for EMI filter selection and installation.

11.4.2 DC Reactor

DC Reactor is mainly used in inverter and rectifying for increasing power factor and filtering interference of stripe, voltage, current, and decreasing inverter harmonic interference.

1, Performance Index of DC Reactor

- 1) Rated working voltage: DC 500V~DC540V;
- 2) Dielectric strength: iron core-winding 2500VAC/50Hz/5mA/60S, no flashover breakdown;
- 3) Insulation Resistance: iron core-winding 500VDC, insulation resistance $\geq 100M\Omega$;
- 4) Reactor noise is lower than 65dB (test at the point of 1m horizontal distance with reactor)
- 5) Temperature rise is less than 70K.

2, Parameter Configuration of DC Reactor

Inverter Power (KW)	Reactor Model	Size L*W*H (mm)	Mounting Dimension (mm)	Terminal Aperture (mm)
1.1	DLK-3A	80*65*110	63*47	φ4
1.5	DLK-6A	80*85*110	63*60	φ4
2.2	DLK-6A	80*85*110	63*60	φ4
3.0	DLK-12A	100*100*125	80*70	φ4
4.0	DLK-12A	100*100*125	80*70	φ4
5.5	DLK-23A	110*120*135	87*70	φ4
7.5	DLK-23A	110*120*135	87*70	φ4
9.0	DLK-33A	110*120*135	87*70	φ4
11.0	DLK-33A	110*120*135	87*70	φ4
15.0	DLK-33A	110*120*135	87*70	φ4

11.4.3 Input Reactor

AC input reactor is mounted at input terminal of inverter to restrain transmitting harmonic generated by inverter to power grid, reduce interference of inverter harmonic to other components, improve quality of power grid, improve power factors and restrain abnormal fluctuations of power grid voltage and surge current of power grid, stabilize waveform and reduce impact to inverter.

1, Performance index of AC input reactor

- Rated operational voltage: 380V/50Hz;
- Dielectric strength: iron core-winding 3000VAC/50Hz/5mA/60S, no flashover breakdown;
- Insulation resistance: iron core-winding 1000VDC, insulation resistance $\geq 100M \Omega$;
- Reactor noise is less than 70dB (test at the point of 1m horizontal distance with reactor);
- Temperature rise is less than 70K.

2, Parameter Configuration of AC Input Reactor

Inverter Power (KW)	Reactor Model	Size L*W*H (mm)	Mounting Dimension (mm)	Installation Terminal Aperture (mm)
1.1	AKSG-10A/5V	140*75*145	75*55	Φ6
1.5	AKSG-10A/5V	140*75*145	75*55	Φ6
2.2	AKSG-10A/5V	140*75*145	75*55	Φ6
3.0	AKSG-15A/5V	140*75*145	75*55	Φ6
4.0	AKSG-15A/5V	140*75*145	75*55	Φ6
5.5	AKSG-15A/5V	140*75*145	75*55	Φ6
7.5	AKSG-20A/5V	170*150*135	80*70	Φ6
9.0	AKSG-30A/5V	170*150*135	80*70	Φ6
11.0	AKSG-30A/5V	170*150*135	80*70	Φ6
15.0	AKSG-40A/5V	170*150*135	80*70	Φ6

11.4.4 AC output reactor

AC output reactor is mounted at output terminal of inverter to restrain capacitive charging current of connecting cable between inverter and motor, voltage built-up rate of PWM wave of passivated inverter, improve power factor and quality of power grid as well as stabilize waveform.

1, Performance index of AC output reactor

- Rated operational voltage: 380V/50Hz;
- Dielectric strength: cored winding 3000VAC/50Hz/10mA/60S, no flashover breakdown;
- Insulation resistance: cored winding 1000VDC, insulation resistance $\geq 100M\Omega$;
- Reactor noise is less than 65dB (test at the point of 1m horizontal distance with reactor).

2, Parameter Configuration of AC Output Reactor

Inverter Power (KW)	Reactor Model	Size L*W*H (mm)	Mounting Dimension (mm)	Terminal Aperture (mm)
1.1	AKSG-10A/9V	140*75*145	75*55	φ6
1.5	AKSG-10A/9V	140*75*145	75*55	φ6
2.2	AKSG-10A/9V	140*75*145	75*55	φ6
3.0	AKSG-15A/9V	140*75*145	75*55	φ6
4.0	AKSG-15A/9V	140*75*145	75*55	φ6
5.5	AKSG-15A/9V	140*75*145	75*55	φ6
7.5	AKSG-20A/9V	170*150*135	80*70	φ6
9.0	AKSG-30A/9V	170*150*135	80*70	φ6
11.0	AKSG-30A/9V	170*150*135	80*70	φ6
15.0	AKSG-40A/9V	170*150*135	80*70	φ6

11.5 Shielded Cable

In order to meet EMC requirements of CE, it must use shielded cable with shielded layer. Shielded cable has 3 phase conductive shielded cable and 4 phase conductive shielded cable. If conductive performance of shielded layer cannot meet requirement, it would add one separate PE wire or use 4 phase conductive shielded cable with one PE wire.

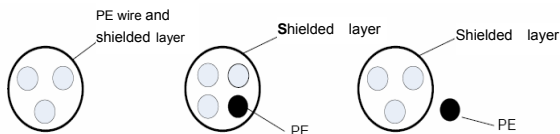

In order to restrain shooting and conducting of radio frequency effectively, shielded layer of shielded cable makes up of coaxial copper intertexture. For increasing shielding efficiency and conductive performance, intertexture density of shielded layer should be more than 90%.

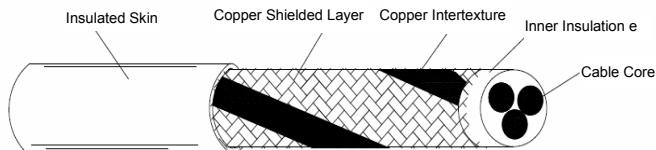

11.6 Cable Wiring Requirements

- 1) Wiring of motor should be far from other cable wirings, and cable of several inverter motors can be wiring side by side.
- 2) Wiring of motor cable, input drive cable and control cable would be in different wire casing. In order to avoid electromagnetic interference of inverter output voltage with fast changing, it should avoid long distance wiring side by side of motor cable and other cables.
- 3) When control cable must cross drive cable, it should ensure the angle of two cables with 90 degree. Do not cross other cables with inverter.
- 4) The drive input, output and weak signal cable (e.g. control cable) of inverter should not wire parallel. With condition available, it is better to wire vertically.
- 5) Please keep good connection of cable wire casings and fine grounding. Aluminum wire casing could improve equipotential voltage.
- 6) Filter, inverter, and motor should be in good connection with system (mechanical equipments) with painting protection of installed parts and sufficient contact with conductive metal.

Wiring distance as below fig.

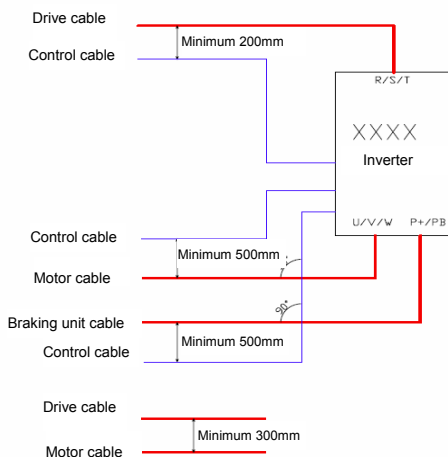



- 1) In somewhere CE conformed or EMC radiation must be reduced, cable entry should keep high frequency ground in 360 degree to restrain electro magnetic interference. In addition, cable shield layer should connect with PE wire to meet safety regulation.
- 2) In floating or high ground (>30Ohms) power system, EMI filter cannot be installed.

11.7 Leakage current response requirements

- 1) The output of inverter is high-speed pulse voltage, therefore it will generate high frequency leakage current. To prevent electro shock and fire evoked by leakage current, please install leakage circuit breaker for inverter.
- 2) The leakage current produced by inverter is relatively large, instant leakage current of large power inverter may be tens of milliamperes, so inductive current of leakage circuit breaker should be larger than 100mA.
- 3) High frequency pulse interference might cause leakage circuit breaker malfunction under interference, please choose leakage circuit breaker with a high frequency filter.
- 4) If to install several inverters, each inverter should have a leakage circuit breaker.
- 5) Factors that affect leakage current, as follows:
 - ◆ Inverter capacity
 - ◆ Carrier frequency
 - ◆ Type and length of motor cable
 - ◆ EMI filter
- 6) When leakage current of inverter cause leakage circuit breaker work:
 - ◆ Improve sensitivity of the current value of leakage circuit breaker
 - ◆ Replace a new leakage circuit breaker with high frequency inhibition function
 - ◆ Reduce carrier frequency
 - ◆ Shorten length of output cable
 - ◆ Install a leakage suppression equipment

11.8 Common EMC Interference Problem and Solution

Frequency inverter is strong anti-interference equipment, when there is problem in wiring and ground connection, still maybe will comes out interference. When it happens, we have below solutions:

Interference Type	Solution
Leakage protection switch trip	<ul style="list-style-type: none"> ◆ Motor case connect the PE of frequency inverter; ◆ Frequency inverter PE connect the power system PE; ◆ Add Safety capacitance box on input power wire; ◆ Add magnetic loops on input power wire;
Running Drive leads Interference	<ul style="list-style-type: none"> ◆ Motor case connect the PE of frequency inverter; ; ◆ Frequency inverter PE connect the power system PE; ◆ Add Safety capacitance box and magnetic loops on input power wire; ◆ Add Capacitor or magnetic loops on the interferenced port ; ◆ Share the ground wire between the equipments;
Communication Interference	<ul style="list-style-type: none"> ◆ Motor case connect the PE of frequency inverter; ; ◆ Frequency inverter PE connect the power system PE; ◆ Add Safety capacitance box and magnetic loops on input power wire; ◆ Add matched resistor On communication wire and load end; ◆ Add communication common GND on communication wire; ◆ communication wire use shielded wire, shields connect public Communication;
I/O Interference	<ul style="list-style-type: none"> ◆ Add capacitor filter on low-speed DI, maximum 0.1uF; ◆ Add capacitor filter on AI, maximum 0.22uF; ◆ Analog signal use shielded wire, shields connect PE of frequency inverter.

Remark: If you have any other EMC interference questions, please contact the manufacturer.

Chapter 12 Optional Components

12.1 I/O expansion card introduction

□ Model:IOV-D104, PN: 050M008003000

Applicable to V350-4T0040 and above models with Class II appearance; the expansion configuration of standard I/O expansion card is as follows:

- 1-channel 485 communication interface;
- Providing $\pm 10V$ auxiliary power supply;
- 3-channel digital input DI;
- 1-channel high-speed programmable pulse input;
- 1-channel analog voltage ($-10V\sim 10V$) input;
- 1-group programmable relay contact output.

Table 12-1: Introduction to terminals of I/O expansion card

Terminal Type	Terminal Name	Function
Communication Interface	RS+, RS-	RS485 communication physical interface; The details refer to FA parameter.
Auxiliary Power Supply	+10V,-10V	Provide $\pm 10V/\max. 10mA$ power supply for external devices.
Analog Input	AI3	Analog voltage input: $-10V\sim 10V$, input impedance $\geq 100M\Omega$, the details refer to F4 parameter.
Digital Input	DI7,DI8	Effective closure with CM terminal, input frequency $\leq 1KHz$; The details refer to F3 parameter.
	DI9	High-speed programmable pulse input and effective closure with CM terminal, frequency $\leq 100KHz$; The details refer to F3 parameter.
Digital Output	DO3	High-speed programmable OC output, output frequency $\leq 100KHz$, the details refer to F3 parameter.
Programmable Relay Output	TA1	TA1-TB1 normally closed contact; TA1-TC1 normally open contact; Contact capacity: AC 250V/1A
	TB1	
	TC1	
Common Terminal	GND	$\pm 10V$, AI3 common terminals
	CM	DO3, DI7, DI8, DI9 common terminals

□ Model: IOV-A100 PN: 050M008061201

Applicable to V350-4T0030/2S0022 and above models with Class I appearance; the expansion configuration of standard I/O expansion card is as follows:

- 5-channel digital input;
- 1-channel NPN type digital output;
- 2-channel analog input (voltage and current input);
- 1-channel analog output (voltage or current output);
- 1-channel 10V/20mA auxiliary power supply;
- 1-channel 24V/100mA auxiliary power supply;
- 1-group programmable relay contact output (220VAC/1A).

Table 12-3: introduction to terminals of Class A I/O expansion card

Terminal Type	Terminal Name	Function
Digital Input	DI1~DI5	Effective closure with CM terminal, input frequency $\leq 1\text{KHz}$
Digital Output	DO	Optical coupling isolation, NPN type OC output; output frequency $\leq 1\text{KHz}$ Withstand voltage: max. 0~24V; sink current capacity: 0~50mA
Analog Input	AI1	Input voltage: 0~10V; input impedance: $\geq 100\text{K}\ \Omega$
	AI2	Input current: 0~20mA; input resistance: 250 Ω
Analog Output	AO	Output: 0~10V (10mA load capacity) or 0~20mA
Auxiliary Power Supply	+10V	Power supply for external potentiometer. Output current: 10mA
	+24V	Provide 24V power supply. Output current: 100mA
Programmable Relay Output	TA	Contact capacity: Normally open contact: 240V AC 2A, Normally closed contact: 240V AC 1A,
	TB	
	TC	
Common Terminal	GND	AI1, AI2, AO, +10V common terminal
	CM	Digital input/digital output/24V common terminal

□ Model: IOV-A101

Applicable to V350-4T0030/2S0022 and above models with Class I appearance; the expansion configuration of standard I/O expansion card is as follows:

- 4-channel digital input, 1-channel high-speed digital input;
- 1-channel high-speed NPN type digital output;
- 2-channel, providing analog input (voltage and current input);
- 1-channel analog output (voltage or current output);
- 1-channel 10V/20mA auxiliary power supply;
- 1-channel 24V/100mA auxiliary power supply;
- 1-group programmable relay contact output (220VAC/1A).

Table 12-4: Introduction to IOV-A01 terminal of I/O expansion card

Terminal Type	Terminal Name	Function
Digital Input	DI1~DI4	Effective closure with CM terminal, input frequency $\leq 1\text{KHz}$
	DI5	In addition to DI~DI4 function, it also serves as high-speed pulse input terminal. Max. input frequency: $\leq 100\text{KHz}$
High-speed Digital Output	DO	Optical coupling isolation, NPN type OC output; Output frequency: $\leq 50\text{KHz}$ Withstand voltage: max. 0~24V Sink current capacity: 0~50mA
Analog Input	AI1	Input voltage: 0~10V Input impedance: $\geq 100\text{K}\ \Omega$
	AI2	Input current: 0~20mA Input resistance: 250 Ω
Analog Output	AO	Output: 0~10V (10mA load capacity) or 0~20mA
Auxiliary Power Supply	+10V	Power supply for external potentiometer. Output current: 10mA
	+24V	Provide 24V power supply. Output current: 100mA
Programmable Relay Output	TA	Normally open contact: 240V AC 2A, Normally closed contact: 240V AC 1A,
	TB	
	TC	
Common Terminal	GND	AI1, AI2, AO, +10V common terminal
	CM	Digital input/digital output/24V common terminal

□ Model: IOV-A102

Applicable to V350-4T0030/2S0022 and above models with Class I appearance; the expansion configuration is as follows:

- 4-channel digital input;
- 1-channel NPN type high-speed digital output;
- 2-channel analog input (voltage and current input);
- 1-channel analog output (voltage or current output);
- 1-channel 10V/20mA auxiliary power supply;
- 1-channel 24V/100mA auxiliary power supply;
- 1-channel 485 communication interface;
- 1-group programmable relay contact output (220VAC/1A).

Table 12-5: Introduction to OV-A102 terminal of I/O expansion card

Terminal Type	Terminal Name	Function
Digital Input	DI1~DI4	Effective closure with CM terminal, input frequency $\leq 1\text{KHz}$
High-speed Digital Output	DO	Optical coupling isolation, NPN type OC output; Output frequency: $\leq 50\text{KHz}$ Withstand voltage: max. 0~24V Sink current capacity: 0~50mA
Analog Input	AI1	Input voltage: 0~10V
	AI2	Input current: 0~20mA Input resistance: 250 Ω
Analog Output	AO	Output: 0~10V(10mA load capacity) or 0~20mA
Auxiliary Power Supply	+10V	Output current: 10mA; Power supply for external potentiometer.
Auxiliary Power Supply	+24V	Output current: 100mA; Provide 24V power supply.
Programmable Relay Output	TA	Normally open contact: 240V AC 2A, Normally closed contact: 240V AC 1A,
	TB	
	TC	
Communication Interface	RS+	RS485 communication physical interface
	RS-	
Common Terminal	GND	AI1, AI2, AO, +10V common terminal
	CM	Digital input/digital output/24V common terminal

□ Model: IOV-A103

Applicable to V350-4T0030/2S0022 and above models with Class I appearance; the expansion configuration is as follows:

- 1-group +12V power supply (load capacity $\leq 100\text{mA}$);
- 3-channel PG signal single-ended input;
- 4-channel quantity input;
- 1-channel high-speed digital input;
- 2-channel analog input (voltage and current input);
- 1-group programmable relay contact output (220VAC/1A).

Table 12-6: Introduction to IOV-A103 terminal of I/O expansion card

Terminal Type	Terminal Name	Function
Digital Input	DI1~DI4	Effective closure with CM terminal, input frequency $\leq 1\text{KHz}$
	DI5	In addition to DI~DI4 function, it also serves as high-speed pulse input terminal. Max. input frequency: $\leq 100\text{KHz}$
Analog Input	AI1	Input voltage: $0\sim 10\text{V}$ Input impedance: $\geq 100\text{K}\Omega$
	AI2	Input current: $0\sim 20\text{mA}$ Input resistance: 250Ω
Auxiliary Power Supply	+12V	Provide +12V/max. 200mA current for external devices
Single-ended Input	A	Access to NPN type encoder A-phase output, max. frequency $\leq 100\text{KHz}$
	B	Access to NPN type encoder B-phase output, max. frequency $\leq 100\text{KHz}$
	Z	Access to NPN type encoder Z-phase output, max. frequency $\leq 100\text{KHz}$
Programmable Relay Output	TA	Normally open contact: 240V AC 2A, Normally closed contact: 240V AC 1A,
	TB	
	TC	
Common Terminal	GND	AI1, AI2 common terminal
	CM	digital input/+12V common terminal

12.2 PG expansion card introduction

V350 series inverters adopt closed-loop vector control mode; when user is engaged in such mode, it's necessary to select PG card fittings. PG card can receive encoder signals of single-ended open-collector output, push-pull output and differential output.

Precautions for use of PG expansion card:

- 1) Signal lines and power lines of PG expansion card shall be laid separately; no parallel routing.
- 2) In order to avoid interference to encoder signals, please employ shielded cable as signal line of PG card.
- 3) The shielded layer of encoder shielded cable shall be grounding (e.g. E terminal of inverter), in addition, it's necessary to adopt single-ended grounding mode to avoid interference to signals.

12.2.1 Standard Type PG Expansion Card

□ Model: PGV-C000, PN: 050M009012002

Applicable to V350-4T0040 and above models, the expansion configuration of standard type expansion card is as follows:

- Provide a group of +12V power supply (load capacity \leq 500mA);
- Provide standard interface for three-phase differential input of incremental encoder;
- Differential voltage \leq +12V;
- Max Resolution: 8190 C/T;
- Response frequency \leq 500KHz.

Table 12-2: Introduction to terminals of standard type PG expansion card

Terminal Type	Terminal Name	Function
Auxiliary Power Supply	+12V	Provide +12V/load capacity \leq 200mA for external devices
Common Terminal	GD	Power supply reference ground
Differential Input	A+	Encoder A-phase differential input (+12V \pm 20%), max. frequency \leq 100 KHz
	A-	
	B+	Encoder B-phase differential input (+12V \pm 20%), max. frequency \leq 100 KHz
	B-	
	Z+	Encoder C-phase differential input (+12V \pm 20%), max. frequency \leq 100KHz
	Z-	

12.3 Brief introduction to operation panel

12.3.1 Outside view of operation panel

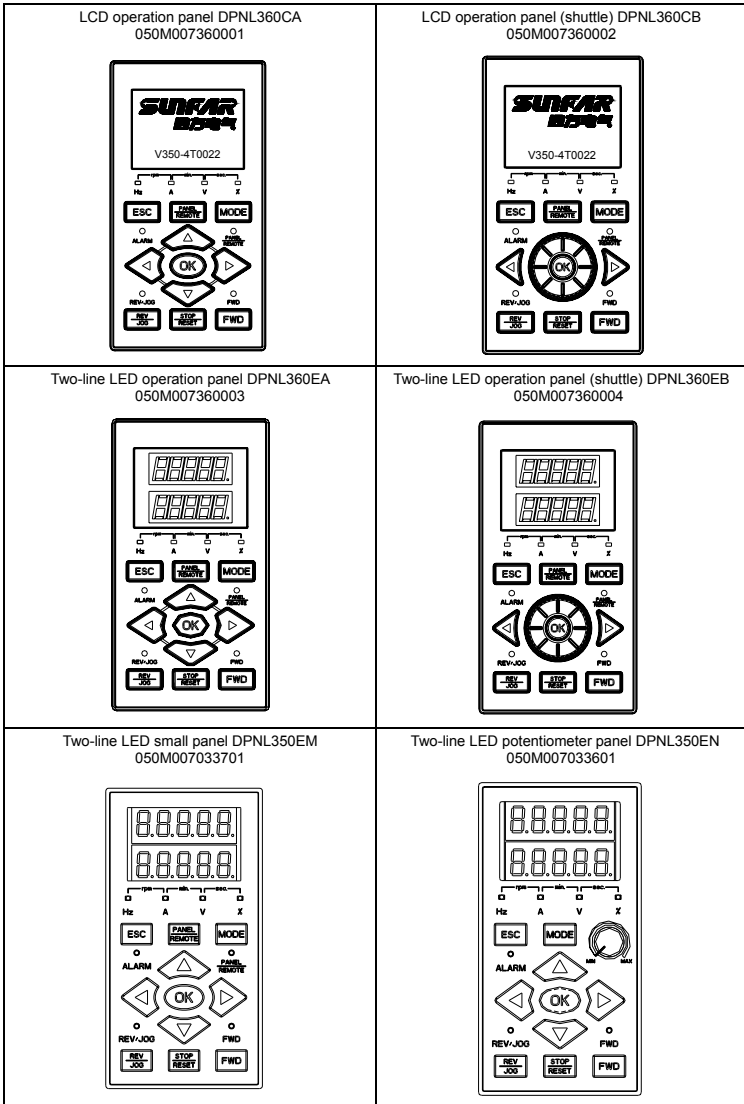

12.3.2 Button function

Button function and operation mode of LCD panel refer to Chapter 5.

12.4 Tension control expansion card

12.4.1 Basic product information

Standard I Type (Model APV-F301) is applicable to V350-4T0040 and above models

Standard II Type (Model APV-B300) is applicable to V350-4T0030/2S0022 and above models

12.4.2 Product introduction

Tension control expansion card is a expansion card that is compatible with V series inverters, and is applicable to wire drawing machine industry and products related to winding/unwinding control.

The expansion card can calculate the high stable tension control parameters to meet the application requirement in the field on the basis of rolling diameter. As for winding and unwinding operations of wire drawing machine, the tension control on PID adjustment in speed mode can be achieved by means of external speed setting and real-time signals of tension oscillating bar for winding and unwinding, to quickly enable tension oscillating bar at optional position at a time to reach equilibrium position, and to keep stable winding and unwinding performance in high speed operation.

12.4.3 Product function

Rolling diameter calculation	Rolling diameter thickness integral, rolling diameter line speed calculation and rolling diameter frequency ratio calculation, etc.
Constant tension at zero speed	Output 0-100 % adjustable torque at zero speed
Breakage detection	Conduct rapid detection on breakage via feedback input
Tension compensation	Static friction compensation, sliding friction compensation, system inertia compensation and material inertia compensation
Motor switch	Realize roll change function via motor switch
Process PID	Two kinds of PID parameters can be transited smoothly based on rolling diameter to guarantee steady-state wave motions at full reel and empty reel conditions.
Metering function	The function can be realized by line speed integral.

12.4.4 Technical data

Starting torque	Greater than 180%
Smooth starting	Over modulation is less than 10%
Steady-state wave motion	Less than 5%

12.5 Expansion card of all-in-one veneer peeling lathe

12.5.1 Basic product information

Standard I Type (Model APV-D302, coding number: 050M010060501) is applicable to V350-4T0040 and above models.

12.5.2 Product introduction

The expansion card is designed for electric control systems of veneer peeling lathe and all-in-one machine, and is compatible with V series inverters, to realize rotary-cut of round timber and veneer cutting and other round timber processing functions.

12.5.3 Product function

Type	Terminal Name	Function
auxiliary power supply	+24V	Provide +24V/100mA current for external devices
common terminal	GD	Power supply reference ground
Encoder A-phase input	A+	Encoder A-phase differential input (+12V±20%), max. input frequency 100KHz
	A-	
Encoder B-phase input	B+	Encoder A-phase differential input (+12V±20%), max. input frequency 100KHz
	B-	
digital input	DI7~DI11	Digital input (*), input frequency ≤1KHz
digital output	DO3	High-speed programmable OC output
common terminal	CM	DO3, DI7, DI8, DI9 common terminals

12.5.4 Technical data

Veneer thickness uniformity	Under the circumstance of sound mechanical features, the thickness uniformity deviation of cut full plate veneer is less than ± 0.05mm;
Veneer tail-board uniformity	The thickness uniformity deviation of last rotary-cut part (30mm) is less than ± 0.10 mm;
Slitting board width	The width deviation of middle board is ±2mm
Tail-board length	Deviation: ±20mm

12.6. Guide of brake resistance selection

Users are able to select resistance value and power according to actual needs, (but selected resistance value can't be lower than recommended value in below table, while selected resistance power can be bigger). Selection of brake resistance depends on motor generation power in system, and in concern with system inertia, deceleration time, energy of potential energy load etc. The bigger system inertia, shorter deceleration time and more frequent braking time, then to choose bigger power of brake resistance and lower resistance value.

12.6.1 Resistance value selection

While braking, almost all motor regeneration energy consumes at braking resistance. The formula:

$$U^2/R=P_b$$

U---- braking voltage under stable system braking state (it varies from different systems, it takes 700V for common AC 380V system)

P_b----power of braking

12.6.2 Power of brake resistance selection

The power of brake resistance and power of braking keep consistent in theory, but should take 70% derating into account. The formula:

$$0.7 \cdot P_r = P_b \cdot D$$

P_r---- power of brake resistance

D---- braking frequency (time proportion of regeneration process accounts for the whole process), generally it is 10%. Please refer to table below:

Type	Lift	Winding & unwinding	Centrifuge	Accidental braking load
Proportion	20%~30%	20%~30%	50%~60%	5%

Brake resistance selection table

Model	Adaptive motor (KW)	Power of brake resistance (KW)	Brake resistance value (Ω)	Brake torque (100%)	Brake unit
Single phase AC 220V					
V350-2S0007	0.75	0.1	≥ 100	100	Standard
V350-2S0011	1.1	0.2	≥ 95	100	Standard
V350-2S0015	1.5	0.2	≥ 70	100	Standard
V350-2S0022	2.2	0.2	≥ 50	100	Standard
Three phase AC 380V					
V350-4T0011	1.1	0.3	≥ 400	100	Standard
V350-4T0015	1.5	0.5	≥ 300	100	Standard
V350-4T0022	2.2	0.65	≥ 200	100	Standard
V350-4T0030	3.0	0.75	≥ 150	100	Standard
V350-4T0040	4.0	1.0	≥ 125	100	Standard
V350-4T0055	5.5	1.5	≥ 85	100	Standard
V350-4T0075	7.5	2.0	≥ 65	100	Standard
V350-4T0090	9.0	2.5	≥ 60	100	Standard
V350-4T0110	11	2.5	≥ 50	100	Standard
V350-4T0150	15	3.6	≥ 35	100	Standard

12.7 AC/DC reactor

12.7.1 DC reactor

DC reactor is mainly designed for inverter and rectifier circuit to improve power factors and filter ripple voltage and current interference.

Performance index of DC reactor

- Rated operational voltage: DC 500V~DC540V;
- Dielectric strength: iron core-winding 2500VAC/50Hz/5mA/60S, no flashover breakdown;
- Insulation resistance: iron core-winding 500VDC, insulation resistance $\geq 100\text{M}\Omega$;
- Reactor noise is less than 65dB (test at the point of 1m horizontal distance with reactor);
- Temperature rise is less than 70K.

Mechanical parameter & Configuration parameter of DC reactor

Inverter Power (KW)	Reactor Model	Dimensions (Length X Width X Height) (mm)	Mounting Dimension (mm)	Terminal Bore Diameter (mm)
1.1	DLK-3A	80*65*110	63*47	φ4
1.5	DLK-6A	80*85*110	63*60	φ4
2.2	DLK-6A	80*85*110	63*60	φ5
3.0	DLK-12A	100*100*125	80*70	φ5
4.0	DLK-12A	100*100*125	80*70	φ5
5.5	DLK-23A	110*120*135	87*70	φ5
7.5	DLK-23A	110*120*135	87*70	φ5
9.0	DLK-33A	110*120*135	87*70	φ5
11.0	DLK-33A	110*120*135	87*70	φ5
15.0	DLK-33A	110*120*135	87*70	φ5

12.7.2 AC input reactor

AC input reactor is mounted at input terminal of inverter to restrain transmitting harmonic generated by inverter to power grid, reduce interference of inverter harmonic to other components, improve quality of power grid, improve power factors and restrain abnormal fluctuations of power grid voltage and surge current of power grid, stabilize waveform and reduce impact to inverter.

□ Performance index of AC input reactor

- Rated operational voltage: 380V/50Hz;
- Dielectric strength: iron core-winding 3000VAC/50Hz/5mA/60S, no flashover breakdown;
- Insulation resistance: iron core-winding 1000VDC, insulation resistance $\geq 100\text{M}\Omega$;
- Reactor noise is less than 70dB (test at the point of 1m horizontal distance with reactor);
- Temperature rise is less than 70K.

□ Mechanical parameter & configuration parameter of AC input reactor

Inverter Power (KW)	Reactor Model	Dimensions (Length X Width X Height) (mm)	Mounting Dimension (mm)	Terminal Bore Diameter (mm)
1.1	AKSG-10A/5V	140*75*145	75*55	φ6
1.5	AKSG-10A/5V	140*75*145	75*55	φ6
2.2	AKSG-10A/5V	140*75*145	75*55	φ6
3.0	AKSG-15A/5V	140*75*145	75*55	φ6
4.0	AKSG-15A/5V	140*75*145	75*55	φ6
5.5	AKSG-15A/5V	140*75*145	75*55	φ6
7.5	AKSG-20A/5V	170*150*135	80*70	φ6
9.0	AKSG-30A/5V	170*150*135	80*70	φ6
11.0	AKSG-30A/5V	170*150*135	80*70	φ6
15.0	AKSG-40A/5V	170*150*135	80*70	φ6

12.7.3 AC output reactor

AC output reactor is mounted at output terminal of inverter to restrain capacitive charging current of connecting cable between inverter and motor, voltage built-up rate of PWM wave of passivated inverter, improve power factor and quality of power grid as well as stabilize waveform.

□ Performance index of AC output reactor

- Rated operational voltage: 380V/50Hz;
- Dielectric strength: cored winding 3000VAC/50Hz/10mA/60S, no flashover breakdown;
- Insulation resistance: cored winding 1000VDC, insulation resistance $\geq 100\text{M}\Omega$;
- Reactor noise is less than 65dB (test at the point of 1m horizontal distance with reactor).

□ Mechanical parameter & configuration parameter of AC output reactor

Inverter Power (KW)	Reactor Model	Dimensions (Length X Width X Height) (mm)	Mounting Dimension (mm)	Terminal Bore Diameter (mm)
1.1	AKSG-10A/9V	140*75*145	75*55	φ6
1.5	AKSG-10A/9V	140*75*145	75*55	φ6
2.2	AKSG-10A/9V	140*75*145	75*55	φ6
3.0	AKSG-15A/9V	140*75*145	75*55	φ6
4.0	AKSG-15A/9V	140*75*145	75*55	φ6
5.5	AKSG-15A/9V	140*75*145	75*55	φ6
7.5	AKSG-20A/9V	170*150*135	80*70	φ6
9.0	AKSG-30A/9V	170*150*135	80*70	φ6
11.0	AKSG-30A/9V	170*150*135	80*70	φ6
15.0	AKSG-40A/9V	170*150*135	80*70	φ6

Please refer to the company products catalogue for more expansion card options.