

CW-5000/5200 Industrial Chiller User Manual

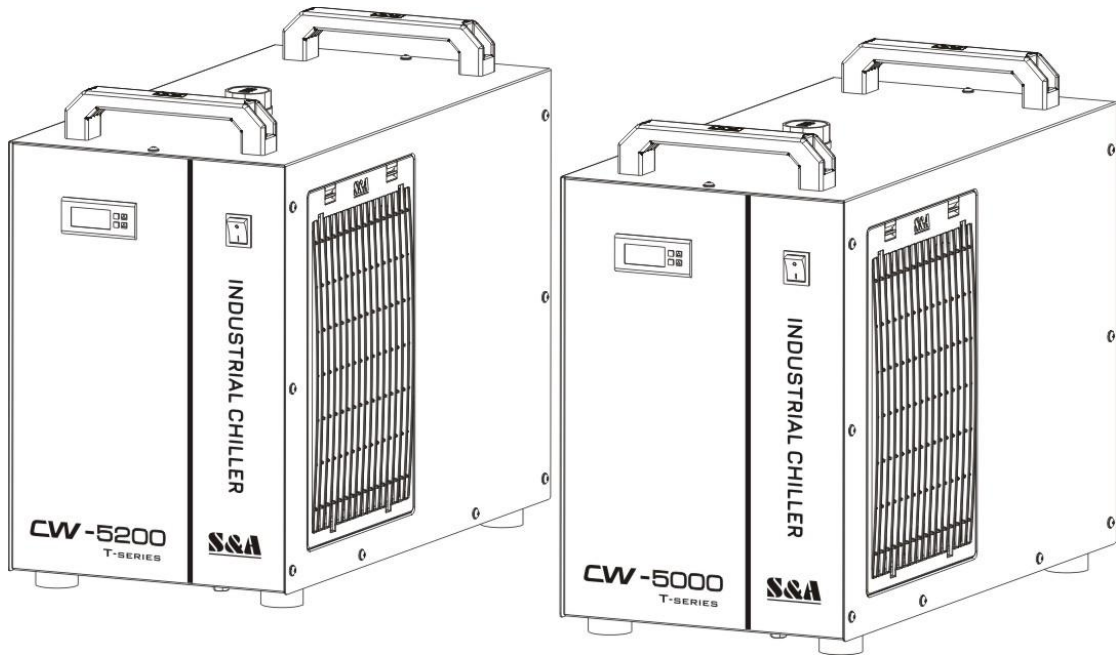

FOREWORD

Thanks for your purchase of our product. Please read this manual carefully before using and keep it properly so that you can refer to it whenever you need information.

This manual is not a quality guarantee. Our company reserves the right to the interpretation of the correction of misprint and improperly described information and product improvement. The revised content will be edited into the reprinted user manual without prior notice.









CONTENTS

Notice -----	4
I. Overview -----	7
II. Model Illustration -----	7
III. Product Outlines & Parts -----	8
IV. Installation -----	9
V. Operating States &Parameters Adjustment -----	11
VI. Alarm & Output Terminal -----	13
VII. Maintenance -----	14
VIII. Simple Troubleshooting -----	15

Notice

In order to ensure your personal safety and avoid property loss, you must pay attention to this manual, but not limited to the following warning notices. General electric knowledge and safety standards should also be followed.

 **DANGER** Failure to take safety measures will result in death or serious personal injury.









Notice		Operation Guideline
 Must-do	The Operation should be carried out by professional technicians	Handling, installation of pipes, electrical, operation, maintenance, overhaul and other operations must be carried out by personnel with professional knowledge.
 Forbidden	It is forbidden to be used beyond the range of specification	It is forbidden to use the equipment beyond the range of manual specifications in order to avoid equipment damage, injury, fire, electric shock and other major accidents.
 Forbidden	It is forbidden to be used in the explosive environment	It cannot be installed in dangerous places with flammable gas.
 Must-do	Electrical connection	a) The power supply must conform to the standard indicated in the nameplate or the manual; b) Use the standard cable, and select the standard wire diameter; c) The grounding wire must be installed and the connection must be reliable; otherwise, it will cause an electric shock or fire.
	It is forbidden to operate the equipment without a cover	There are live parts inside the machine. It is forbidden to operate without a cover, as there is a risk of electric shock.
	Water-proof	Do not allow the equipment to be drenched or immersed in water, otherwise there may be a risk of short circuit and electric shock.
 Must-do	Maintenance and repair	The operation must be carried out after 3 minutes of cutting off the power supply, because the high-voltage charging part in the equipment is not discharged within 3 minutes. Working in a live state or working immediately after shutdown will cause the risk of electric shock.
	Danger High Voltage	Contact with live parts can cause serious personal injury or death.
	Danger Hot Surface	The human body or the heat-labile articles must keep away from this high temperature area. Otherwise, it will cause personal injury or property loss.

DANGER Failure to take safety measures will result in death or serious personal injury.

Notice		Operation Guideline
 Must-do	Transport and installation	The equipment must be firmly fixed during transport and installation. Otherwise, there will be a danger of tipping or falling.
 Must-do	Electrical protection	The power cable terminal must be equipped with the electric leakage and overload protection device according to the rated current indicated on the equipment nameplate.
 Must-do	Stop running in abnormal state	When the equipment is abnormal, as long as the cause is not clear, it is forbidden to start. Otherwise, there is a danger of damage, electric shock, fire, and injury.
 Forbidden	Do not put fingers or other things into the gap of the equipment	There are rotating parts inside the device. Do not put fingers or other things into the gap of the equipment. Otherwise, it will cause personal injury.
 Must-do	Refrigerant leakage	a) When the refrigerant leaks, please make sure that the ventilation is available. Otherwise, it may cause anesthesia and suffocation if a large amount of refrigerant fills the enclosed space; b) Avoid contacting with skin, or it will cause frostbite.

DANGER Failure to take safety measures will result in minor personal injury or property damage.

Notice		Operation Guideline
 Forbidden	Transportation with liquid is prohibited	The equipment is not allowed to be transported with liquid to prevent internal pipeline leakage.
 Must-do	Transport	a) The equipment should be fixed firmly before transportation to prevent the equipment from moving due to vibration and external forces. If there is excessive vibration and external force, the internal equipment may be damaged. b) Tilt angle should be $\leq 45^\circ$. Otherwise, the refrigeration system will fail.
 Forbidden	Operating environment	a) It is forbidden to use in special environments such as high temperature, humidity, strong electromagnetic interference, etc. b) The equipment must be installed in a place where there is no direct sunlight and away from the fire sources.
 Must-do	Installation	a) The equipment must be installed on a horizontal surface. Otherwise, the refrigeration system will fail; b) It is forbidden to place objects within 1 meters around the

		air inlet and 1.5 meters around the air outlet. If the air inlet and the air outlet are blocked, the cooling ability that the equipment should have cannot be realized.
 Must-do	Before commissioning	a) Make sure that the water supply pipe of equipment is not blocked; b) It is necessary to check the water pipe and the water pump to confirm that there is a proper amount of water entering the water pump and exhaust it through the water pump exhaust valve, otherwise it will cause damage to the water pump; c) Confirm that the state of the equipment is normal and safe, otherwise there may be injury and damage.
 Warning	Gently move the motor impeller if the equipment isn't used for a long time	For equipment that has not been used for a long time, it may be difficult to start the pump at the first start. Please gently move the motor impeller before the equipment is powered on.
 Forbidden	The equipment is forbidden to be trampled on	Please do not step on or sit on the equipment. Otherwise, it may cause injury accidents such as falling or overturning
 Must-do	Clean the air filter regularly	Clean the air filter at least once a week. If it is blocked, the cooling ability will decrease and the power consumption will increase, and the alarm will not work properly.
 Must-do	Equipment surface cleaning	a) Please use cleaning agents that are non-corrosive to metals and plastics; b) Please keep the cleaning agent properly after cleaning to prevent liquid leakage; c) The container for storing the cleaning agent must be sealed completely to avoid danger.
 Forbidden	No air blowing at the water outlet	A temp sensor is installed inside the water outlet, and it is forbidden to blow air inside the device with an air gun.
 Must-do	Wear protective gloves during maintenance, inspection and cleaning	a) The sharp edges of the condenser fins may cut the skin; b) The temperature of the internal compressor and refrigerant piping is very high, and direct skin contact may cause burns.
 Must-do	Anti-freezing	a) When the ambient temperature is lower than 0℃ and the machine is shut down for a long time, it is necessary to drain the liquid and blow the water away in the system with compressed air, otherwise there is a danger of freezing and cracking the components and pipelines. b) When room temperature is lower than 0℃, it is recommended to use antifreeze with a concentration of not more than 30% containing ethylene glycol or propylene glycol.

I. Overview

This product is an industrial cooling device designed and manufactured for laser cutting, laser welding, laser marking, laser engraving and other equipment that uses laser processing. It can provide a temperature-stable cooling medium for the above application scenarios.

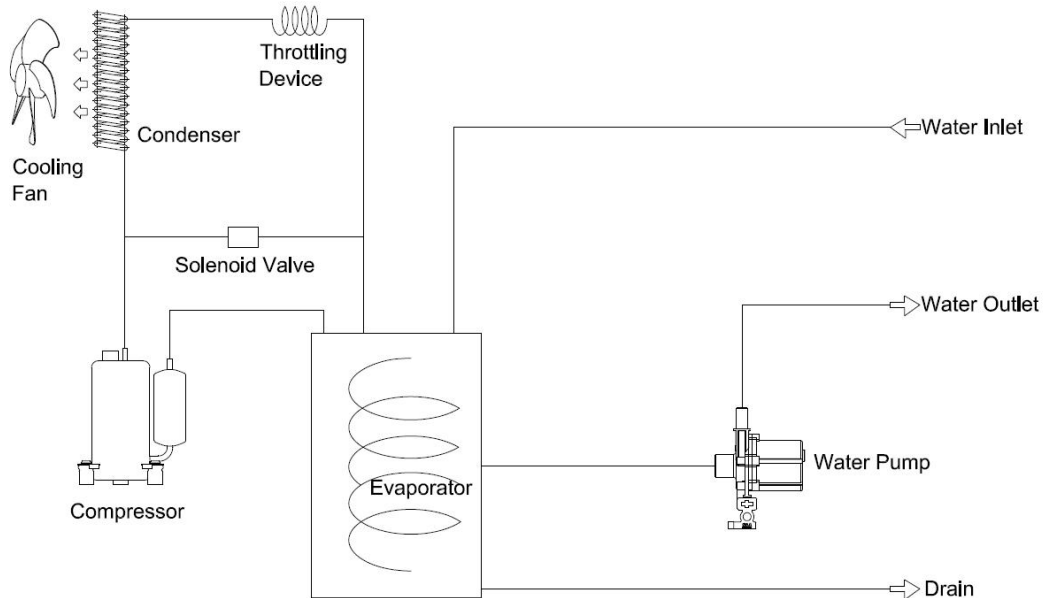

The chiller is composed of a compressor, a condenser, a throttling device (expansion valve or capillary), an evaporator, and a water pump. Its working principle is that the chiller's refrigeration system cools the water, and the water pump delivers the low-temperature cooling water to the equipment that needs to be cooled. Then the cooling water will take away the heat, heat up and return to the chiller, and then be cooled again and transported back to the equipment. In the refrigeration system of a chiller, the refrigerant in the evaporator coil absorbs the heat of the return water and vaporizes into steam. The compressor continuously extracts the generated steam from the evaporator and compresses it. The compressed high-temperature, high-pressure steam is sent to the condenser and later will release heat (heat extracted by the fan) and condense into a high-pressure liquid. After being reduced by the throttling device, it enters the evaporator to be vaporized, absorbs the heat of the water, and the whole process circulates constantly. Users can set or observe the working status of the water temperature through the temperature controller.

II. Model Illustration

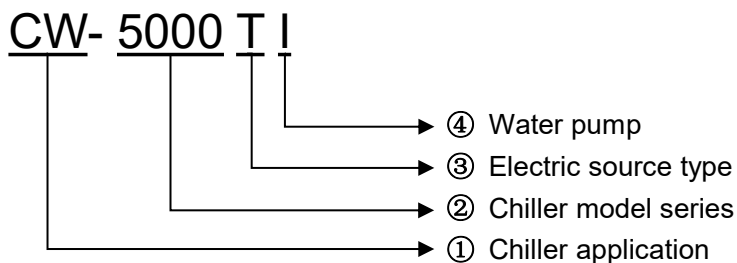

Note: This model description only contains the description of the company's main product codes, not all of them are listed. Please confirm with our company before ordering the specific model, our company has the final interpretation right about it.

III. Product Outlines & Parts

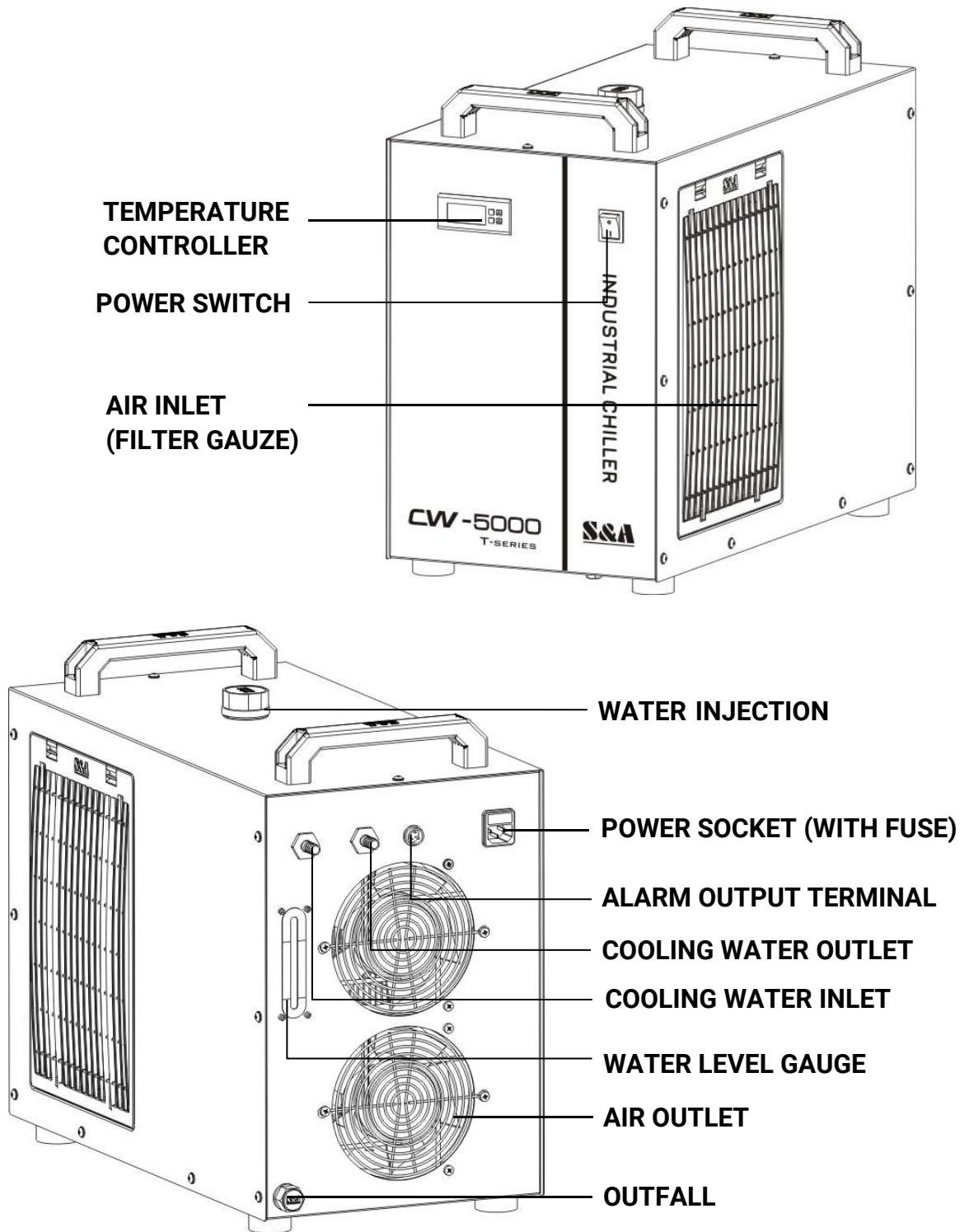

Note: The above-mentioned product outlines and part names are only for one of the models, and they will be slightly different in different models.

IV. Installation

1. Open the package and check whether the machine is in good condition and whether the accessories are complete.

2. Please ensure that the working voltage of the chiller is stable and normal.

Because the refrigeration compressor is sensitive to the power supply voltage, the normal working voltage of our company's standard products is 210~240V (110V model is 100~120V). If wider operating voltage range is necessary, customization is available.

3. Equipment installation conditions and requirements.

(1) It must be installed on a horizontal surface and not tilted.

(2) The air outlet of the chiller should be at least 1.5m away from the obstacle, and the air inlet must be at least 1m away from the obstacle (See below diagram).

(3) Do not install in harsh environments such as corrosive, flammable gas, dust, oil mist, conductive dust, high temperature and humidity, strong magnetic field, direct sunlight, etc.

(4) Operating Environment

Ambient Temperature	Ambient Humidity	Altitude
0~40℃	≤90%RH	≤3,000m

(5) Medium Requirements

Cooling medium allowed by the chiller includes purified water, distilled water, high-purity water and other softened water. It is forbidden to use oily liquids, liquids containing solid particles, corrosive liquids, etc. Clean the filter element and replace the cooling water regularly (about three months is recommended) to ensure the normal operation of the chiller.

When the chiller is stored with water at room temperature lower than 2℃, it is necessary to add anti-freezer in the chiller water tank. It is recommended to use antifreeze with a concentration of not more than 30% containing ethylene glycol or propylene glycol. After the temperature warms up, change to purified water, distilled water or other suggested cooling media, let the chiller run for 30 minutes to remove the residual antifreeze and drain it, and then refill with unused circulating water.

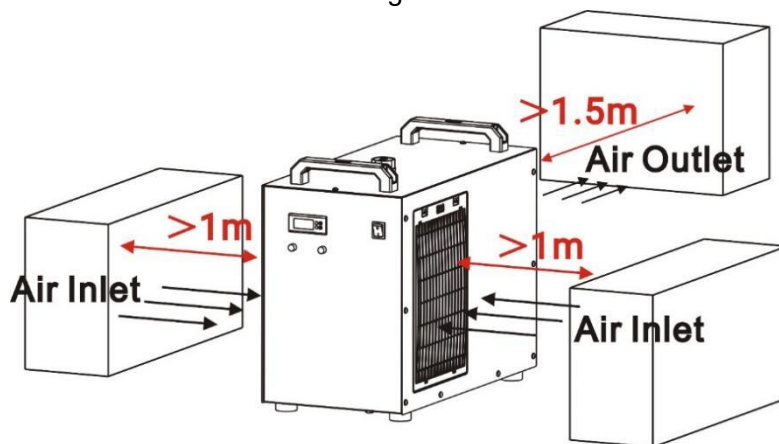

4. Determine the direction of the pipeline layout according to the water inlet and outlet of the chiller, and ensure that the waterway is clean and free of impurities, so as to prevent impurities from entering the waterway and causing blockage or pump failure.

5. Plug in the power cord and turn on the power switch (It is forbidden to start without water).

(1) After turning on the power switch, the circulating pump of the chiller starts to work. When the new machine is turned on for the first time, there will be more air bubbles in the pipeline, which will cause the machine to alarm occasionally, and it will return to normal after a few minutes of operation.

(2) After starting the machine for the first time, check if the water pipes leaks immediately.

(3) After turning on the power, if the water temperature is lower than the set temperature, it is normal that the cooling fan and other devices of the machine do not work. The temperature controller will automatically control the working status of compressors, solenoid valves, cooling fans and other components according to the set parameters.

(4) As it takes a longer time to start over the compressor and other components, according to different conditions, the time is range from seconds to minutes, so do not turn off the power and again on frequently.

6. Electrical connection.

(1) Please select the cable based on the max. rated current indicated on the label of the chiller.

(2) Recommended reference standard for power cord diameter selection.

Rated current/ A	≤5	≤10	≤15	≤25	≤35	≤50
Wire diameter (copper wire)/ mm ²	1.0	1.5	2.5	4.0	6.0	10.0

Note: This data is provided according to IEC 60204-1 standard and only for reference. Standard cables must be used in the power cord.

(3) The main circuit of the power supply must be equipped with appropriate electric leakage and overload protection devices, and the chiller must be well grounded.

(4) Less than ±10% of power supply voltage fluctuation and less than ±1Hz of frequency fluctuation are allowed, and keep away from electromagnetic interference sources.

7. Fill Water & Exhaust Air.

(1) Fill Water

After the new machine is turned on, the air in the water pipe is emptied, and the water level of the water tank will drop slightly. In order to keep the water level in the green area, you can add water again. Observe and write down the current water level. After the chiller has been running for a period of time, observe the water level gauge again. If the water level drops significantly, check again if there is leakage in the water pipes.

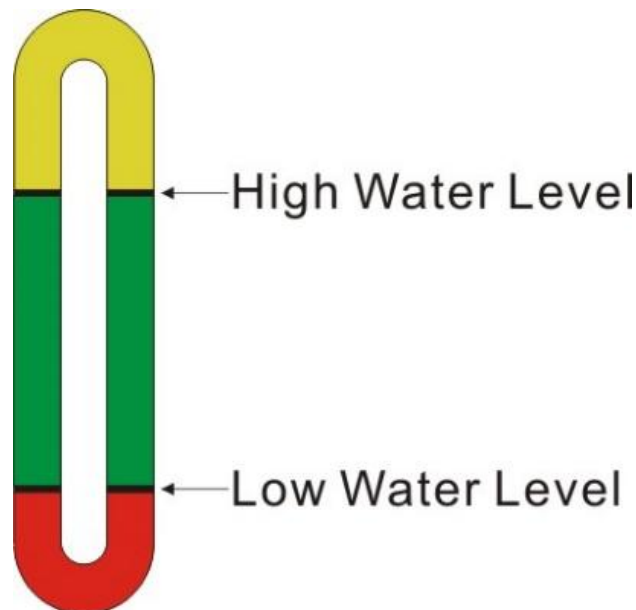

(2) Exhaust Air

After adding water for the first time or replacing water, exhaust the air in the water pump to start use, otherwise the equipment will be damaged. The exhaust method is as follows:
 Method 1: Under the state of shutting down, after adding water, remove the water outlet and connect the water pipe, drain for 2 minutes, and then install it firmly.

Method 2 : Open the water supply inlet, after starting the machine (water flows), repeatedly press and fold the water pipe several times to drain the air from the pipe.

8.Test-run Check.

(1)Check whether the pipeline connection is correct, and there must be no bubbling or water leakage;

(2) Check the liquid level of the water tank;

(3) Confirm that the electrical wiring of the equipment is connected correctly;

(4) Confirm whether the equipment is grounded.

V. Operating States &Parameters Adjustment

The new T-503D intelligent temperature controller does not need to adjust the controlling parameters under normal circumstance. It will self-adjust controlling parameters according to room temperature for meeting equipment cooling requirements.

The new T-504D intelligent temperature controller is selected constant temperature control mode as factory setting with water temperature at 25 °C . User can adjust it as needed.

T-504D and T-504D controllers are of same functions and structure except factory setting.

1.Temperature control panel introduction

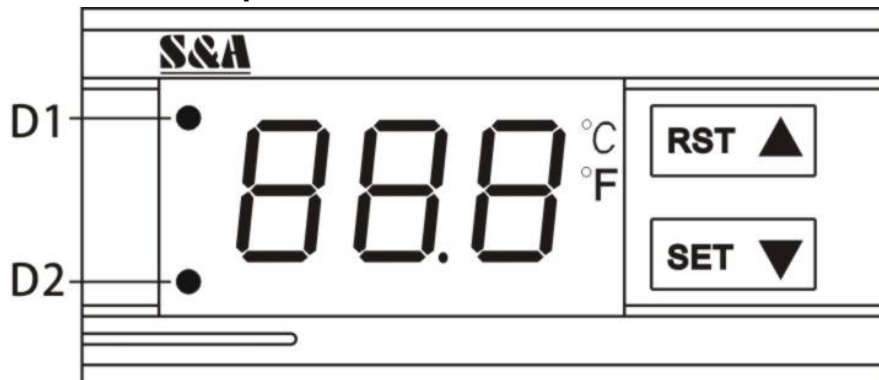

(1).Indicators D1, D2 (as shown) of thermostat working state

D1 ON: thermostat works in intelligent control mode;

D1 OFF: thermostat works in temperature control mode;

D1 FLASHES: thermostat works in parameters setting mode or displays value of room temperature;

D2 ON: chiller works in refrigerating state;

D2 OFF: chiller works in the insulation working state;

D2 FLASHES: chiller works in the energy-saving state;

(2).Press ▼ button will show the room temperature, 6 seconds later to display the restore defaults (Meanwhile, D1 is flashing, displaying room temperature).

(3).▲▼ keys are for adjusting the display status of the controller, parameters selection and adjustment.

(4).RST key: enter key.

(5).SET key: function setting key.

2. Restore to factory settings

Before machine startup, press and keep holding ▲▼ button then turn on the chiller, and

don't release the buttons until the controller displays rE. The controller works in normal order in 6s and is restored to factory settings.

3. Press ▼ key to show t1. Press ▼ key again to show room temperature (Meanwhile D1 is flashing, displaying room temperature);

Continue to press ▼ key to show t2. Press ▼ key again to show flow rate 1.(Unit: L/min);

Continue to press ▼ key to show t3. Press ▼ key again to show flow rate 2.(Unit: L/min);

Continue to press ▼ key to exit display or restore to water temperature display in 6 seconds if no key is pressed.

4. Alarm function

(1) Alarm Display:

When alarm occurs, the error code and the temperature will be alternately displayed.

E1	E2	E3	E4	E5	E6	E7
Ultrahigh room temperature	Ultrahigh water temperature	Ultralow water temperature	Room temperature sensor failure	Water temperature sensor failure	Flow rate 1 alarm	Flow rate 2 alarm

(2) To suspend the alarm:

In alarming state, the alarm sound could be suspended by pressing any button, but the alarm display remains until the alarm condition is eliminated.

5. General settings adjustment

Press SET button (SET) to enter into the user-defined state. Meanwhile, D1 flashes to indicate that the controller is in parameters setup status.

(1) Under intelligent mode, the control panel displays the temperature difference value between water and room (Factory setting is -2).

(2) At this moment, press ▲▼ key to change settings. After modifying the value, press the ENTER button (RST) to save and exit, then new parameters take effect, or press SET key (SET) to exit without saving parameters. If there is no more action within 20 seconds, it will automatically exit modifying status without saving parameters.

6. User parameter adjustment

Press and hold the ▲ key first, and then press "SET" key at the same time for 5 seconds until 00 is displayed, at this time, press the ▲▼ key to select the set password (F7=8), and then press "SET" key. If the password is correct, F0 is displayed, entering the setting state. The panel indicator D1 flashes indicating the controller being in the parameter setting state. If the password is wrong, it will return to temperature display. After entering the setting state, Press the ▲ key to cycle into the selected items, and press ▼ key to cycle in the opposite direction. (Only F0-F11 is displayed) Select the set item and then press the "SET" key to enter the next parameter modification, and the original set value is displayed. At this time, press ▲▼ key to modify the parameter value, and then press "SET" key to return to the previous menu setting item. Press the "RST" key at any time to save the modified parameters and exit, return to the temperature display, and run according to the new parameters. If no key is pressed within 20 seconds, the controller will automatically exit the parameter setting state without saving the modified parameters. (In the parameter setting state, the system runs according to the parameters adjusted immediately.)

7. Advanced parameters adjustment case

Order	Code	Items	Value in Case 1	Value in Case 2
1	F0	Temperature setting		25
2	F1	Temperature Difference Values	-3	
3	F2	Refrigeration return difference	0.5	2.0
4	F3	Way of control	1	0
5	F4	Alarm for over high water temperature	15	5
6	F5	Alarm for over low water temperature	15	10
7	F6	Alarm for over high room temperature	45	45
8	F7	Password	8	8
9	F8	The allowed highest water temperature	31	30
10	F9	The allowed lowest water temperature	25	5
11	F10	Flow 1 alarm value	0.5	0.5
12	F11	Flow 2 alarm value	0.5	0.5

Case 1: cooling water temperature is controlled by intelligent mode. Requiring water temperature to be between 25°C to 31°C. Ambient temperature keeping constant, when the set water temperature is 3°C lower than the ambient, the fluctuation will not exceed $\pm 0.5^\circ\text{C}$. There will be an alert when water temperature is 10°C lower or higher than target (e.g. when ambient temperature is 30.0°C, cooling water temperature is between 27.5°C to 26.5°C, if ambient temperature is up to 30.5°C, water temperature will be between 28.0°C to 27.0°C).

Case 2: cooling water temperature is controlled by constant mode. Requiring water temperature is constant in 28°C, and the fluctuate does not exceed $\pm 2^\circ\text{C}$. The alarm of over high water temperature will be on when water temperature is 7°C (F4+F2) higher than normal, and the alarm of over low water temperature will be on when water temperature is 12°C (F5+F2) lower than normal.

VI. Alarm & Output Terminal

In order to guarantee the equipment will not be affected while abnormal situation happens to the chillers, the chillers are designed with alarm protection function.

1. Alarm output terminals and wiring diagram

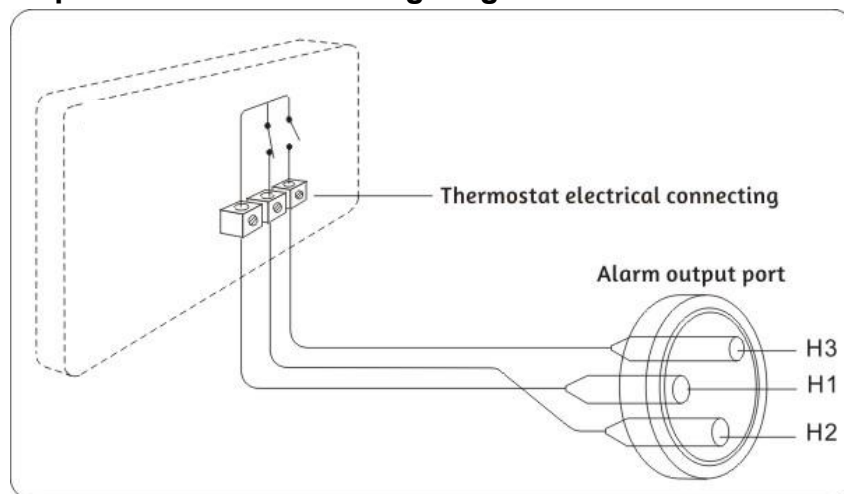

2. Alarm causes and working status table

Condition	Display	Alarm code	Buzzer	OUT H1、 H2	OUT H1、 H3
Circulating pump works properly				DISCONNECTION	BREAKOVER
Ultrahigh room temp		E1	Sounds	BREAKOVER	DISCONNECTION
Ultrahigh water temp		E2	Sounds	BREAKOVER	DISCONNECTION
Ultralow water temp		E3	Sounds	BREAKOVER	DISCONNECTION
Faulted room temp sensor		E4	Sounds	BREAKOVER	DISCONNECTION
Faulted water temp sensor		E5	Sounds	BREAKOVER	DISCONNECTION
Flow rate 1 alarm		E6	Sounds	BREAKOVER	DISCONNECTION
Flow rate 2 alarm		E7	Sounds	BREAKOVER	DISCONNECTION
Chiller power failure				BREAKOVER	DISCONNECTION

Note: The alarm output port is connected with a set of normally open and normally closed contacts of the relay inside the machine. The working current should be smaller than 3A while the working voltage should be smaller than 300V.

VII. Maintenance

The equipment must be shut down for maintenance, and the power supply must be cut off. The operation can only be carried out after 3 minutes, otherwise there will be a risk of electric shock. When the room temperature is lower than 2°C, the internal water must be drained when the machine is shut down for a long time.

Regularly disassemble the filter gauze for cleaning and use a compressed air gun to blow away the dust on the condenser (about 1 week is suggested and the air filter must not be missing for a long time).

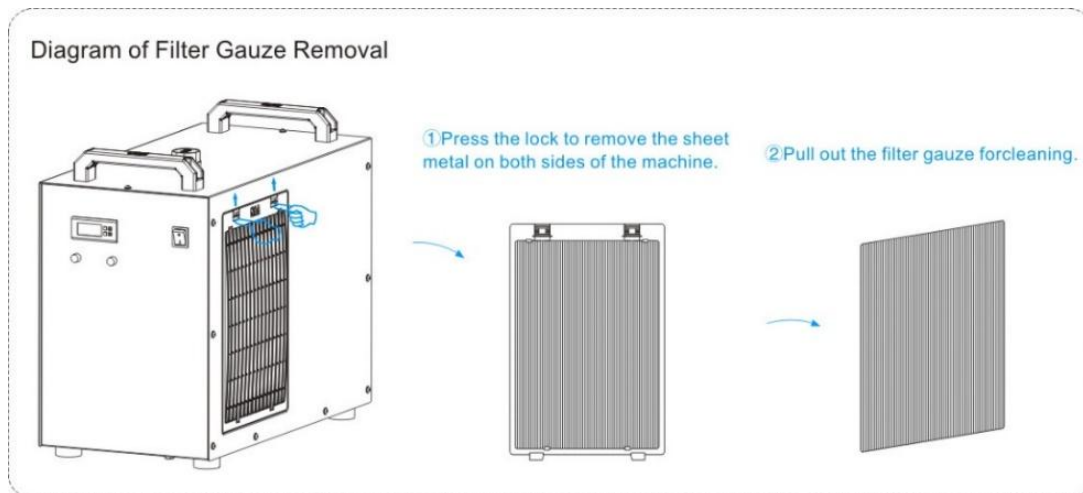

VIII. Simple Troubleshooting

Failure	Failure Cause	Approach
Machine turned on but unelectrified	Power cord is not plugged in place	Check and ensure the power interface and the power plug is plugged in place and in good contact.
	Fuse burnt-out	Pull out the fuse box from the power supply interface of the chiller, check the fuse, replace

		with spare fuse if necessary and check whether the power supply voltage is stable; Check and ensure the power interface and the power plug is plugged in place and in good contact.
Flow Alarm,use a water pipe directly connect to the water outlet and inlet but still without water flowing	Water level in the storage water tank is too low	Check the water level gauge display, add water until the level shown in the green area; And check whether water circulation pipe leaks.
	Water circulation pipes are blocked or a pipe bending deformation.	Check water circulation pipe
Ultra-high temperature alarm	Blocked dust gauze, bad thermolysis	Unpick and wash the dust gauze regularly
	Poor ventilation for air outlet and inlet	To ensure a smooth ventilation for air outlet and inlet
	Voltage is extremely low or unstable	To improve the power supply circuit or use a voltage regulator
	Improper parameter settings on thermostat	To reset controlling parameters or restore factory settings
	Switch the power frequently	To ensure there is sufficient time for refrigeration (more than 5 minutes)
	Excessive heat load	Reduce the heat load or use other model with larger cooling capacity
Alarm for ultra-high room temperature	The working ambient temperature is too high for the chiller	To improve the ventilation to guarantee that the machine is running under 40°C.
Serious problem of condensate water	Water temperature is much lower than ambient temperature, with high humidity	Increase water temperature or to preserve heat for pipeline
Water drains slowly from outfall during water changing	Injection port is not open	Open the injection port